

Размер 58
рост 168 см

Соответствие размеров
смотрите на сайте
«Шкатулка»
<http://materials.tell4all.ru>

Файл с выкройкой и все его фрагменты охраняются
законом об авторском праве. Публикация и распространение
выкройки и ее фрагментов запрещены!

Официальное разрешение предоставлено только следующим
сайтам:

<http://materials.tell4all.ru>

Если Вы обнаружили нарушение авторских прав,
необходимо сообщить об этом по адресу admin@tell4all.ru

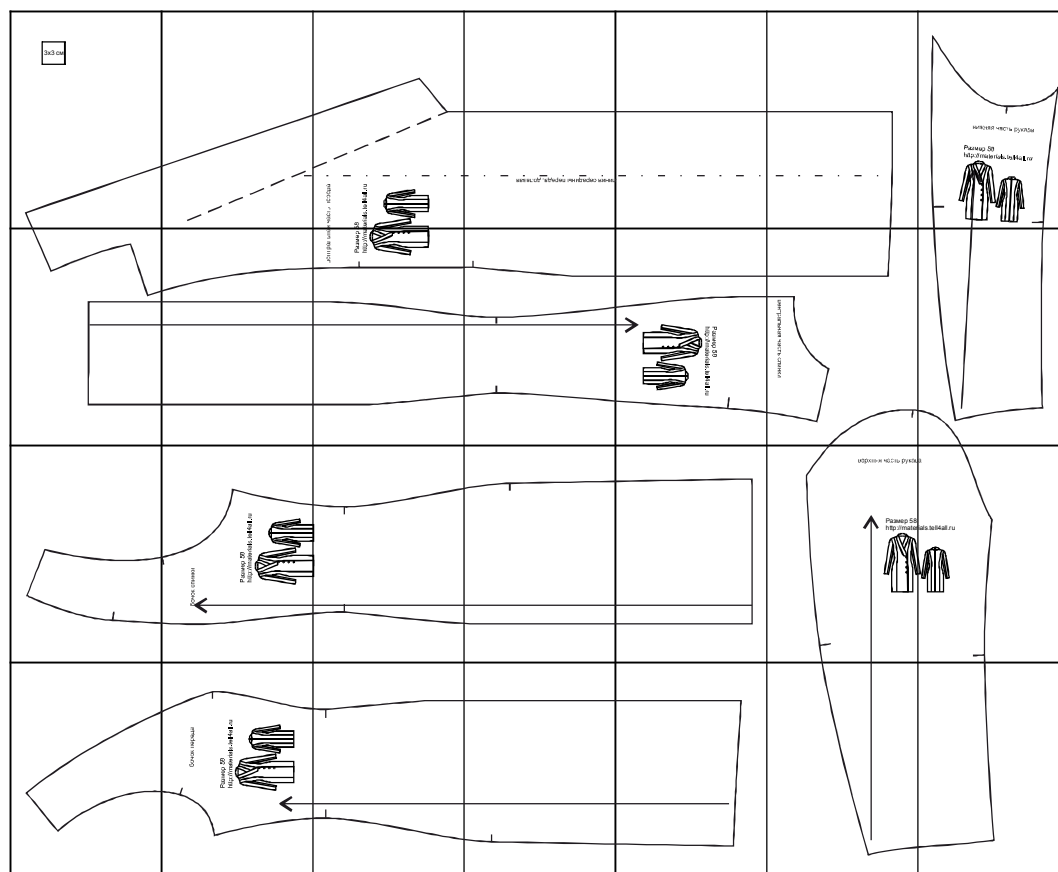

(1, 1)



(2, 1)

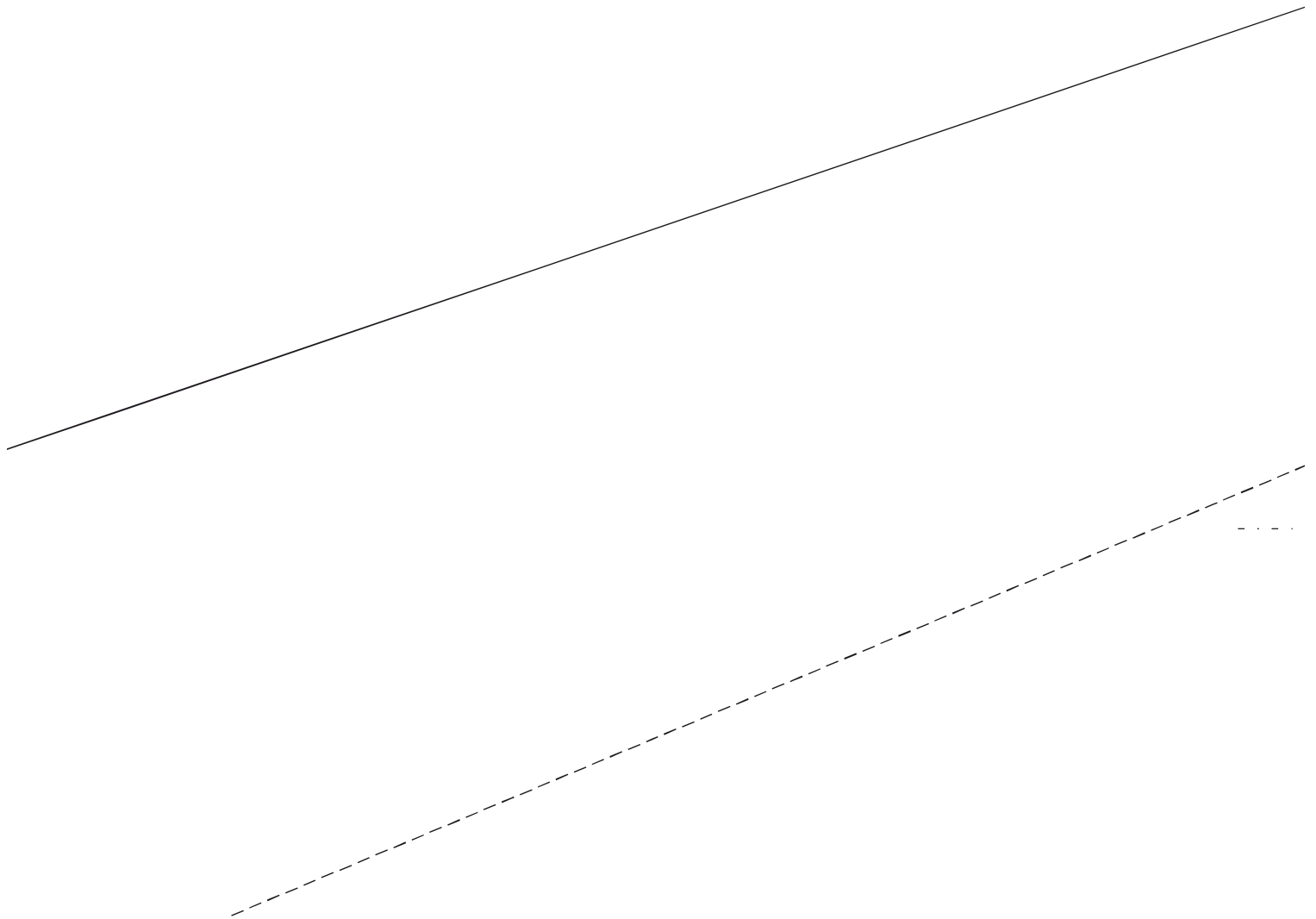

ая часть переда

58

aterials.tell4all.ru

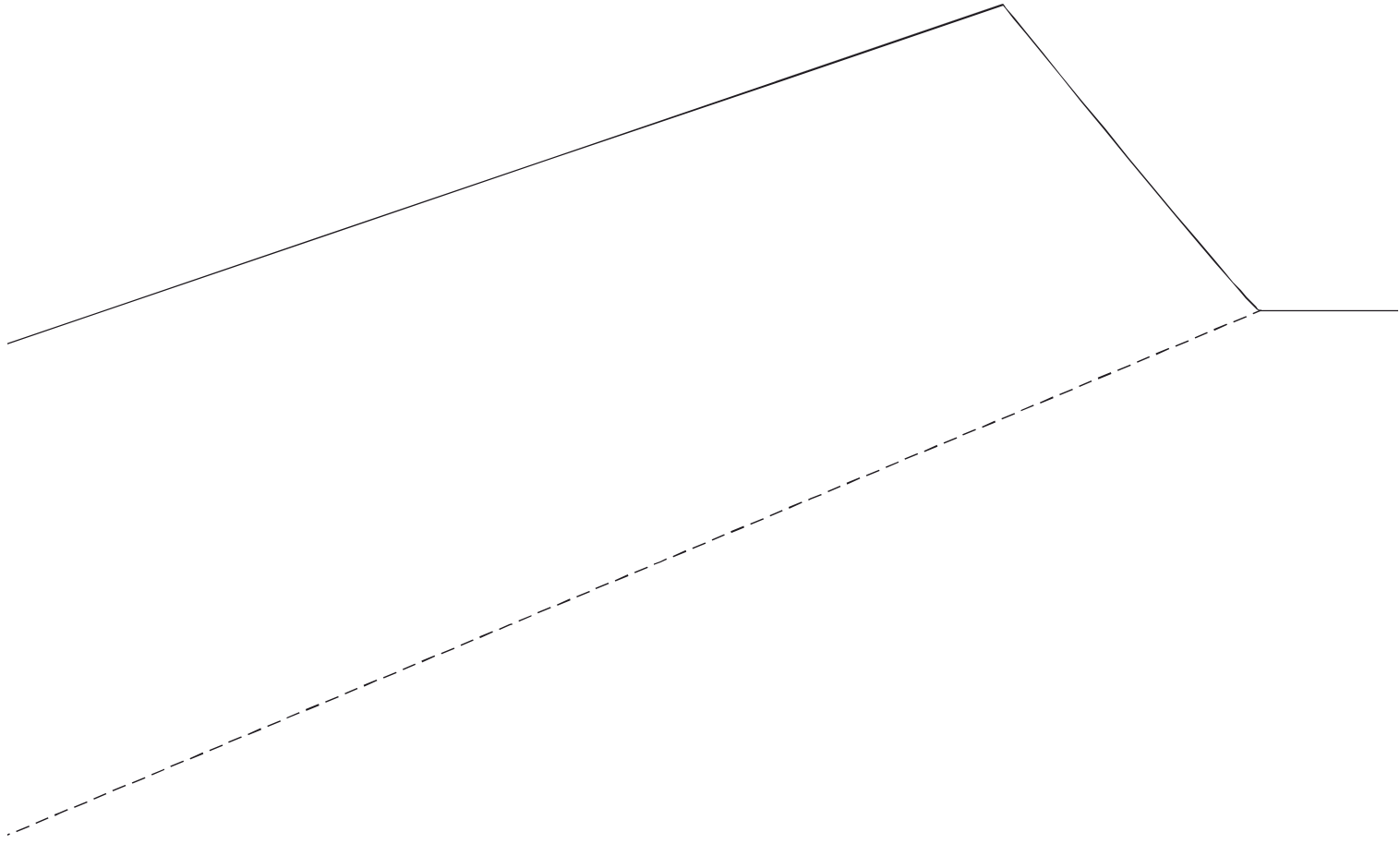
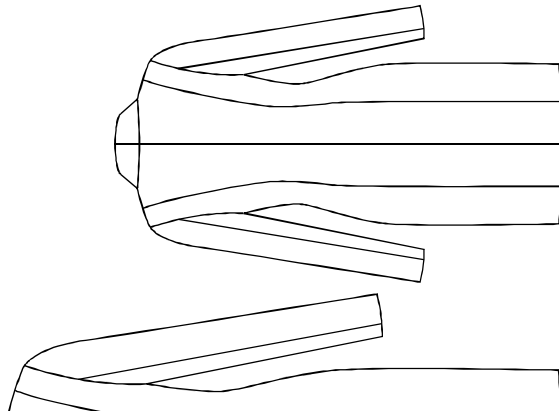

(3, 1)

иния сәрединья перәда, поләваз

(5, 1)

U

(6, 1)

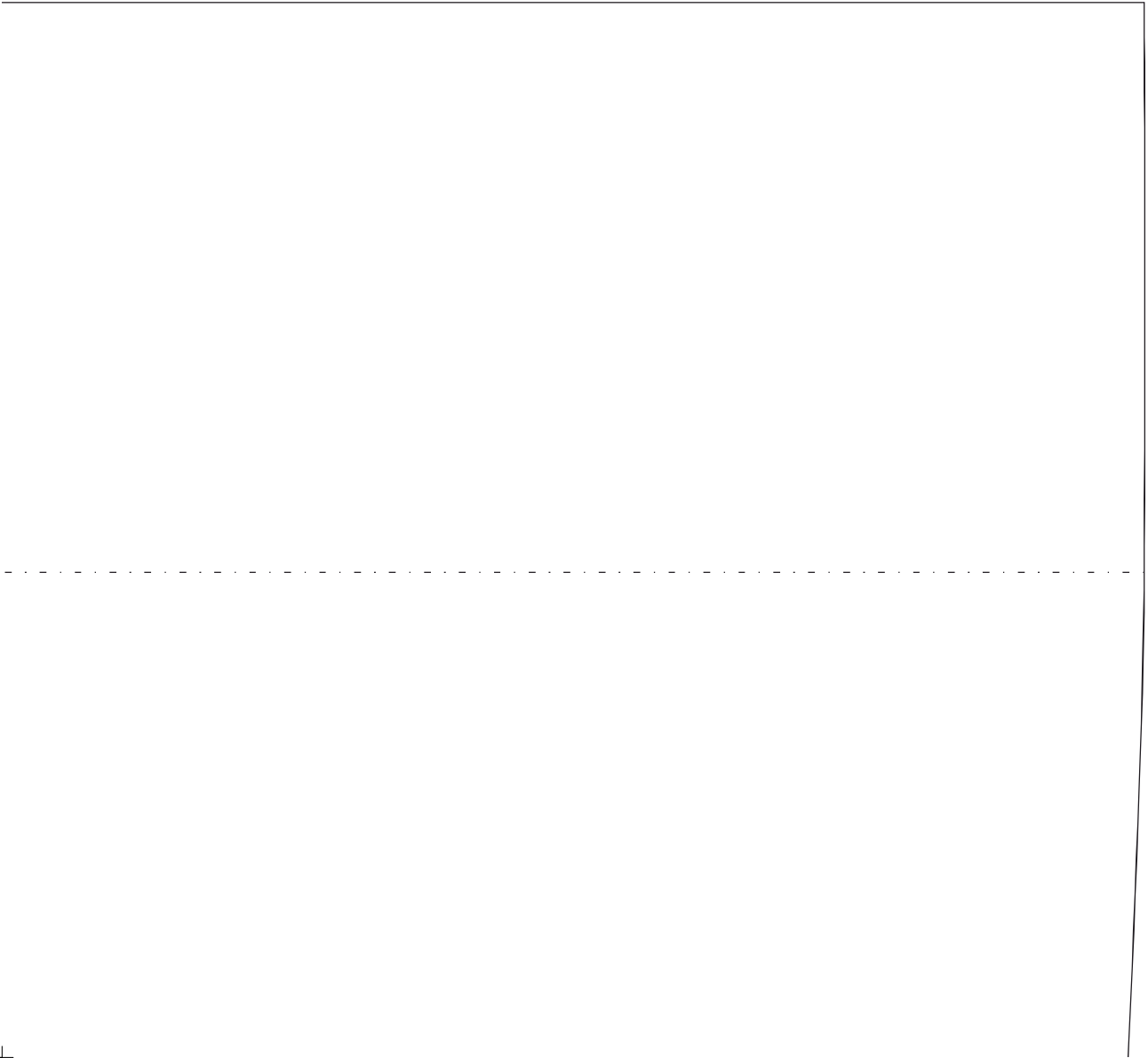

НИЖНЯЯ ЧАСТЬ РУКАВА

Размер 58
<http://materials.tell4all.ru>

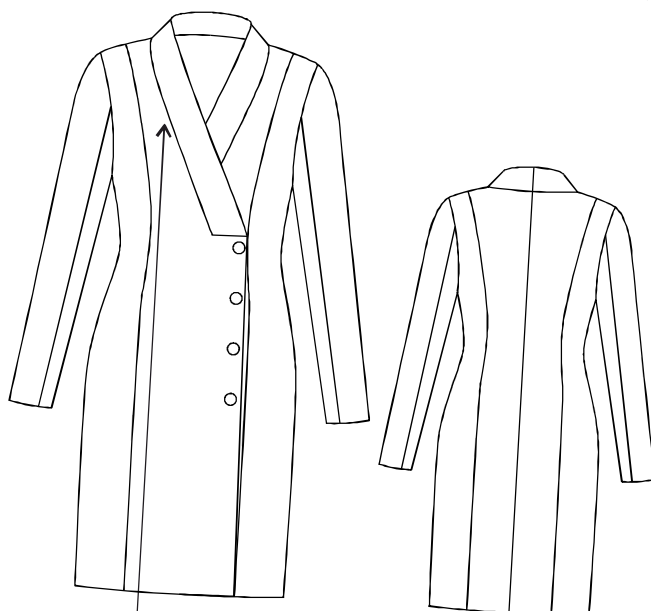



(1, 2)

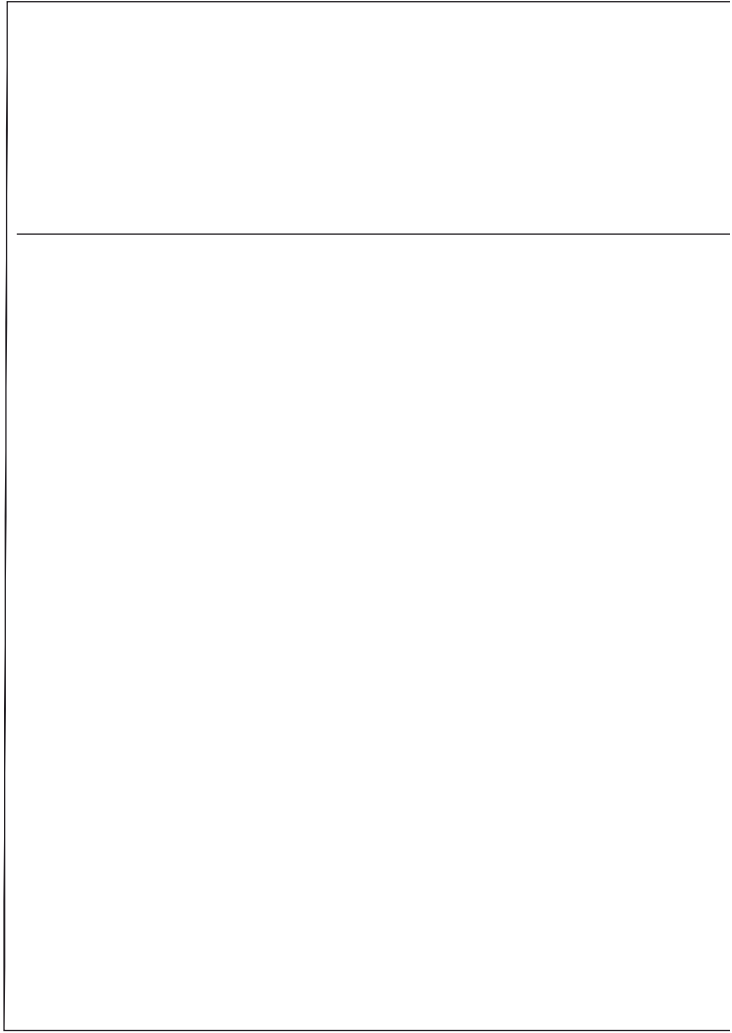
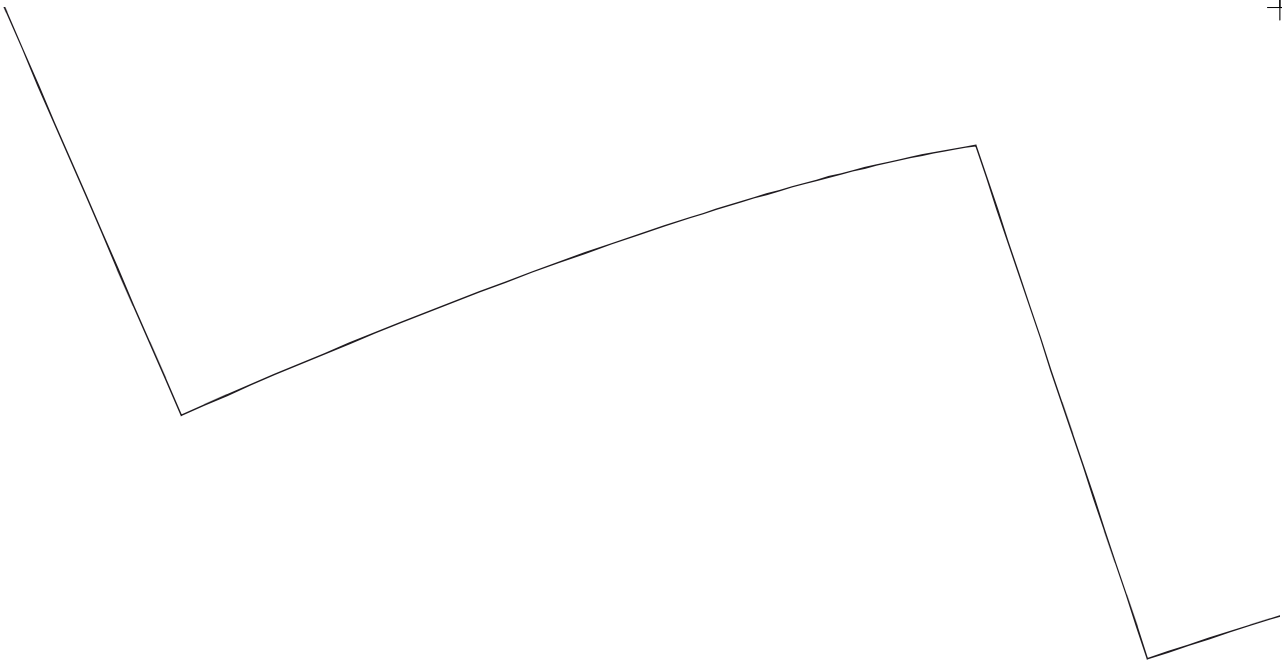

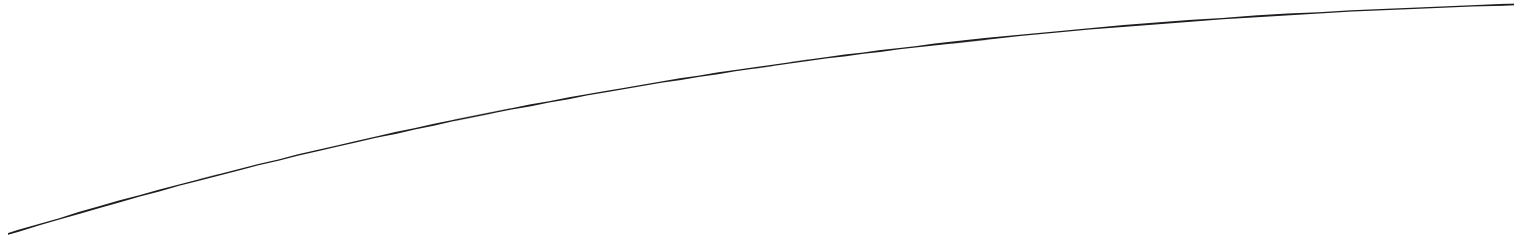

ЦЕНТРАЛЬНІ

Размер
<http://m>

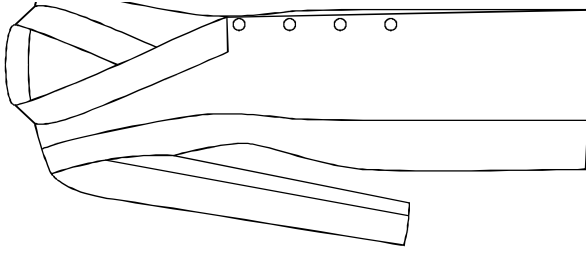

(4, 2)

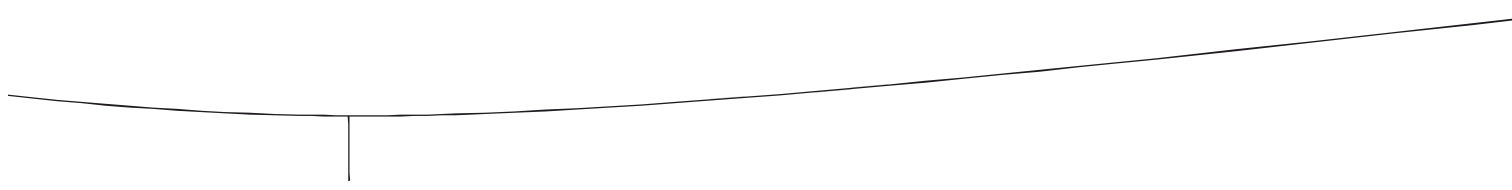
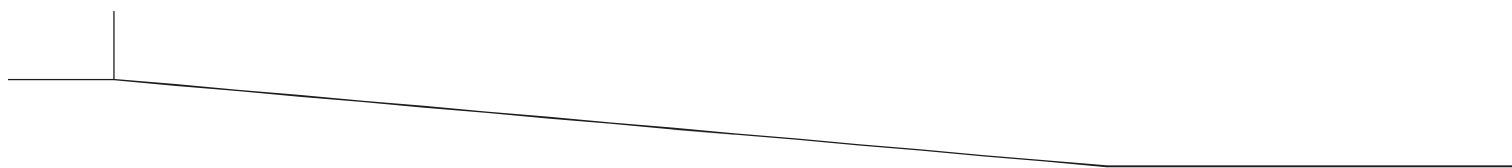

Размер 58
<http://materials.tell4all.ru>

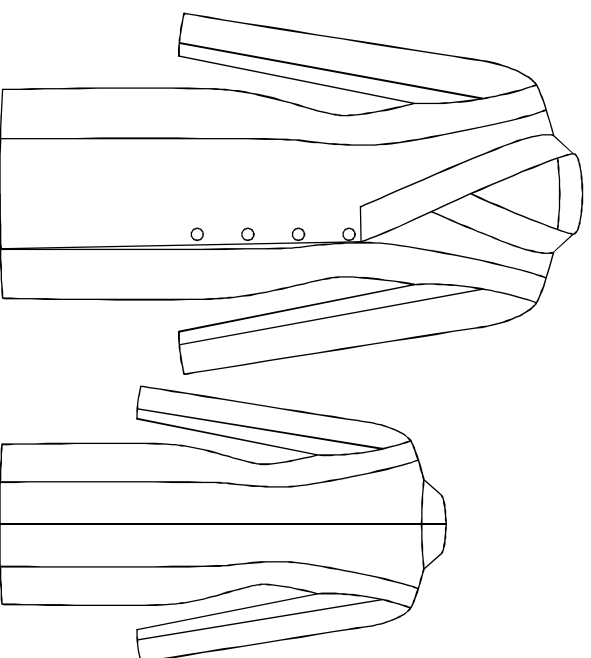

ЦЕНТРАЛЬНАЯ ЧАСТЬ СПИНКИ

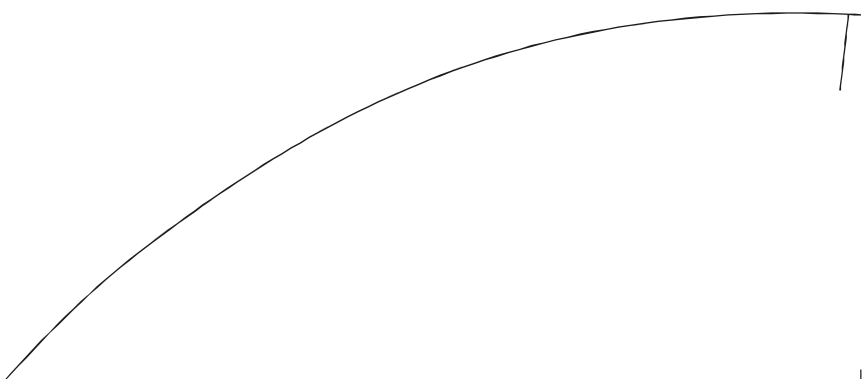
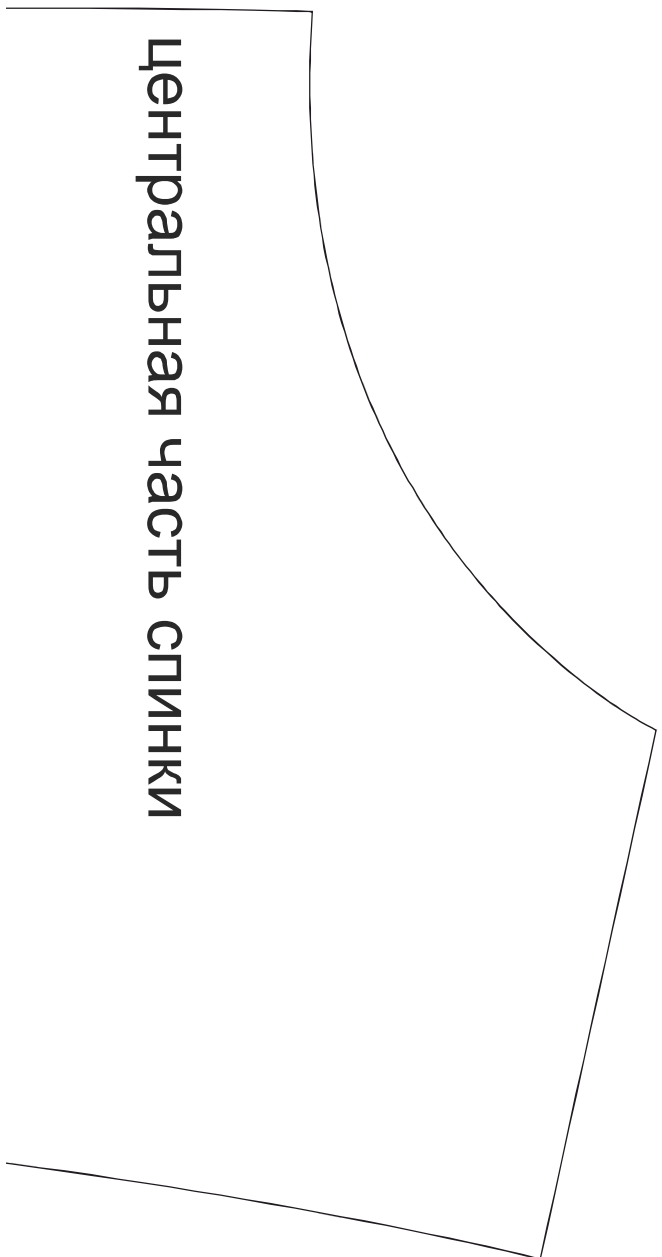

(7, 2)

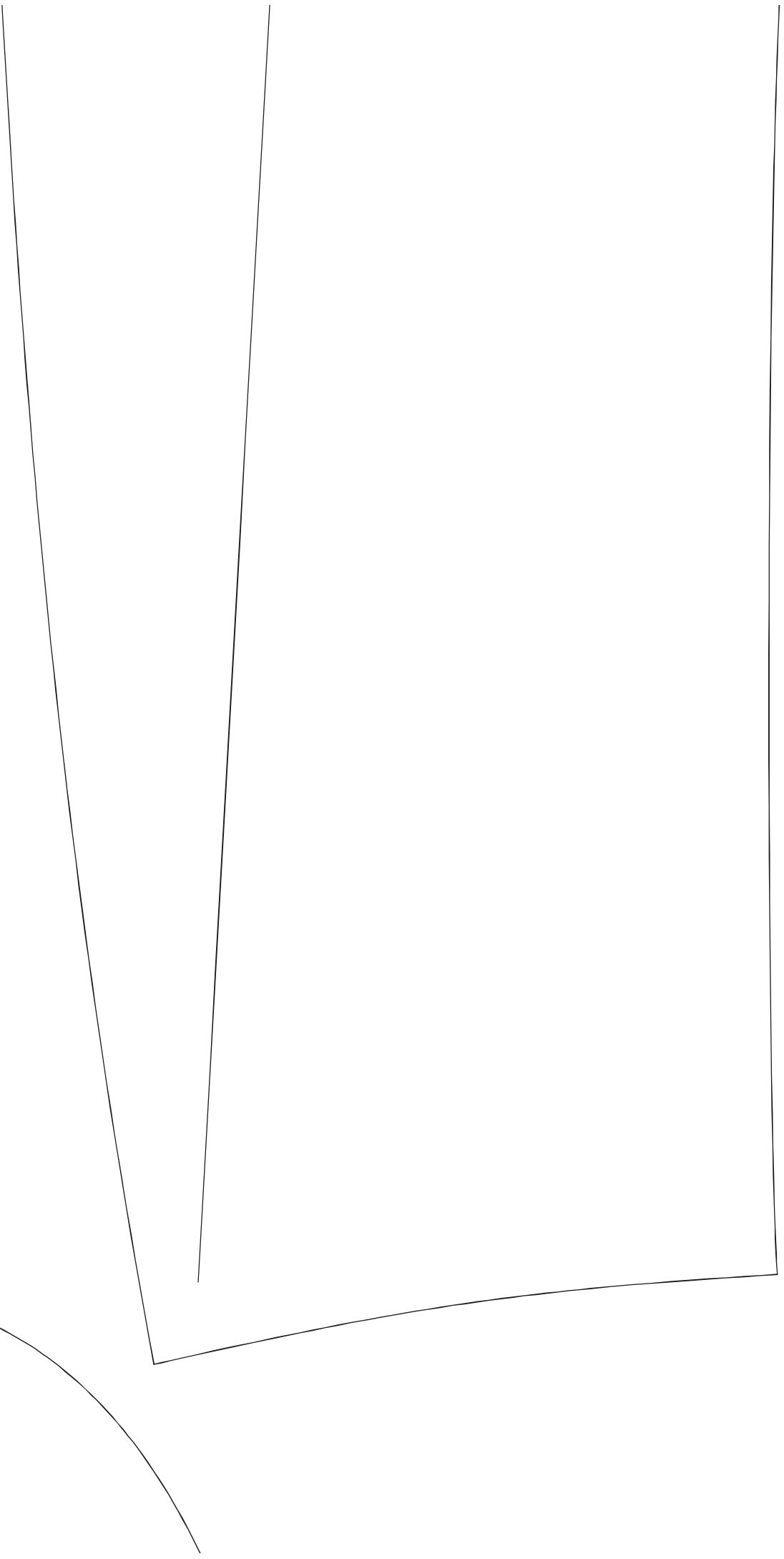

— (1, 3)

+

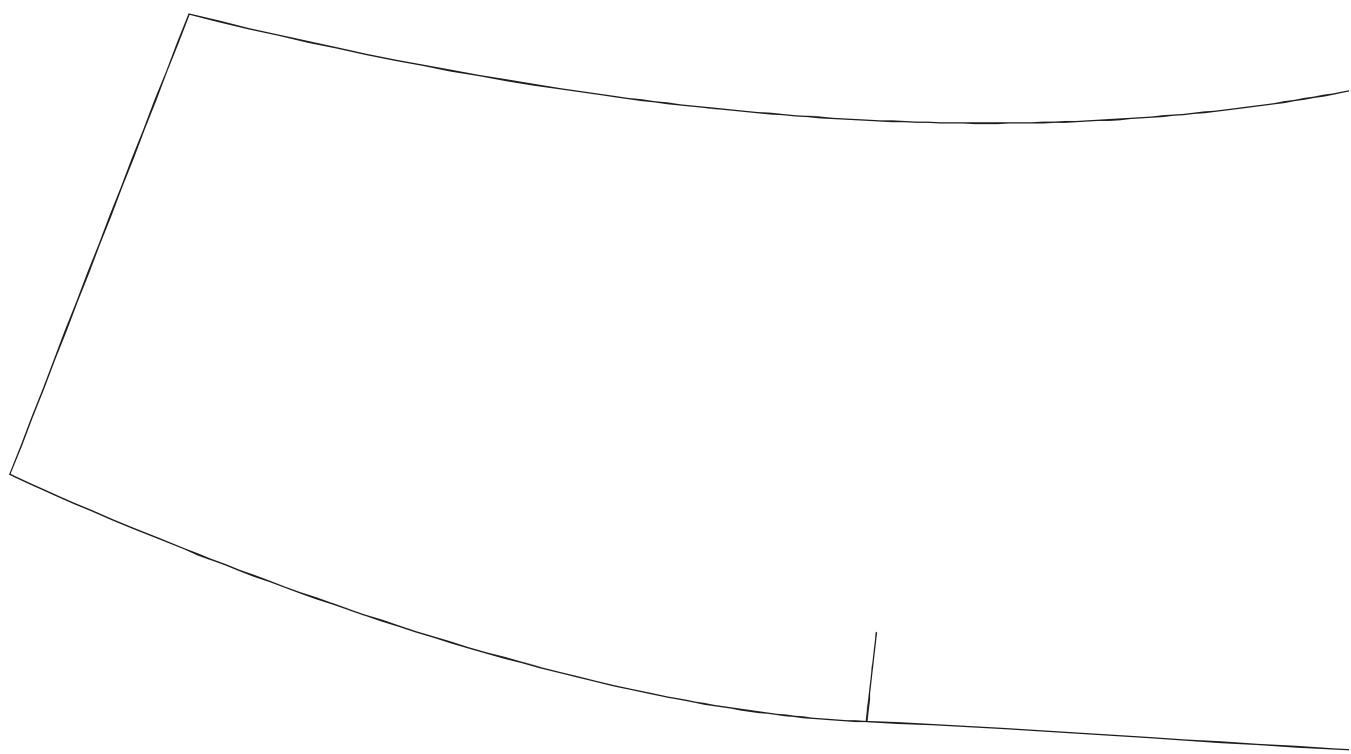

—

+

БОЧОК СПИНКИ

Размер 58
<http://materials.tell4all.ru>

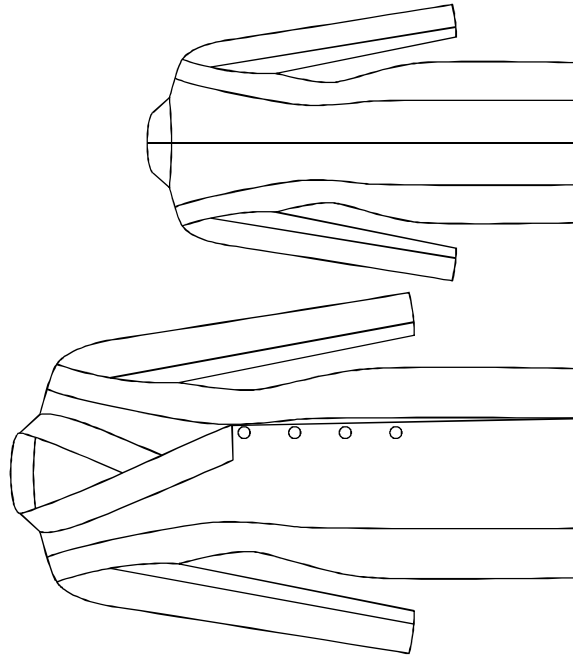

(3, 3)

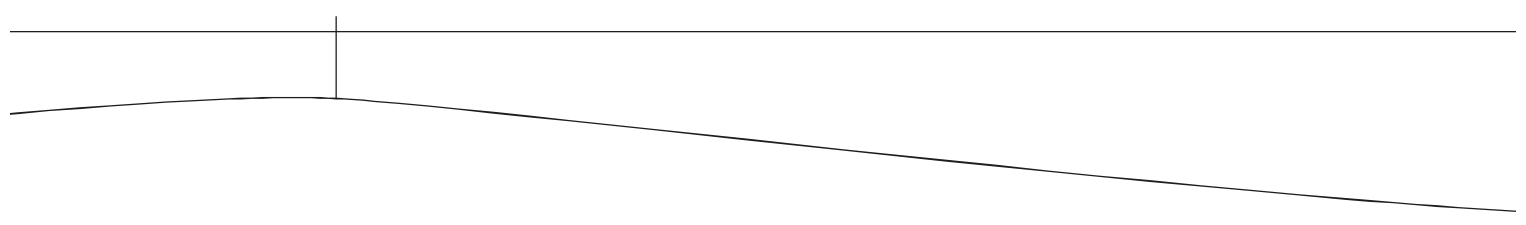
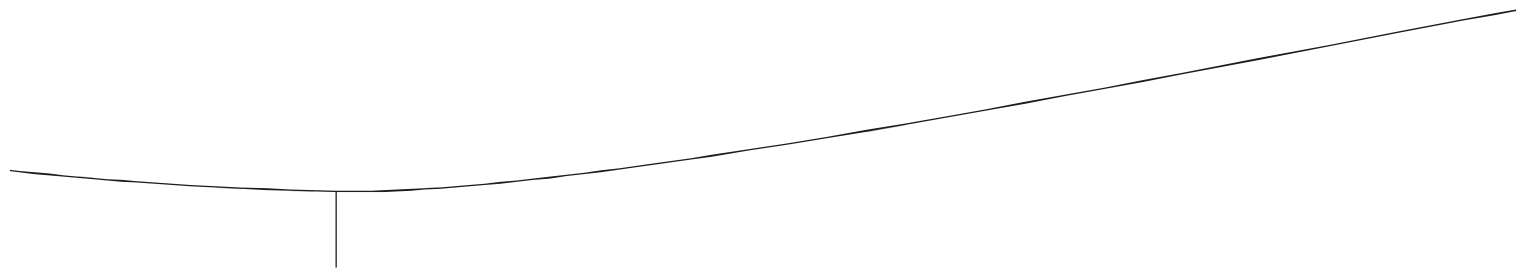

(4, 3)



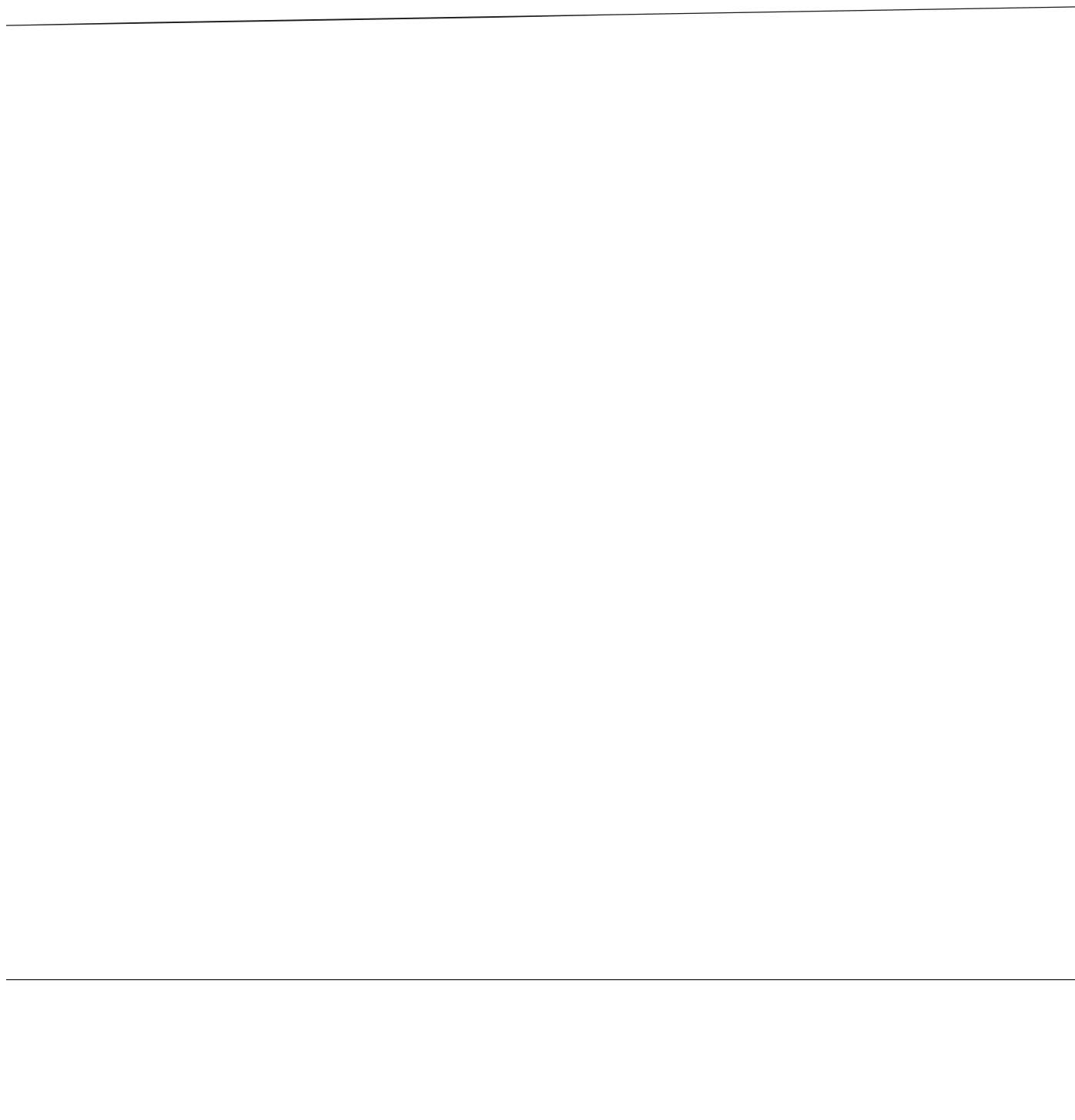

верхняя часть рука

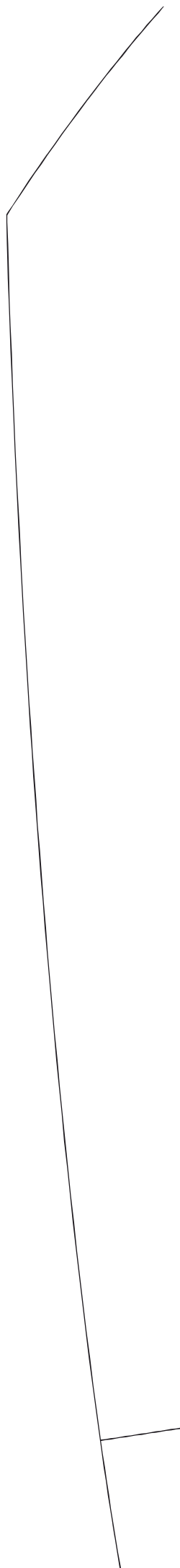

Размер 50
<http://mate>

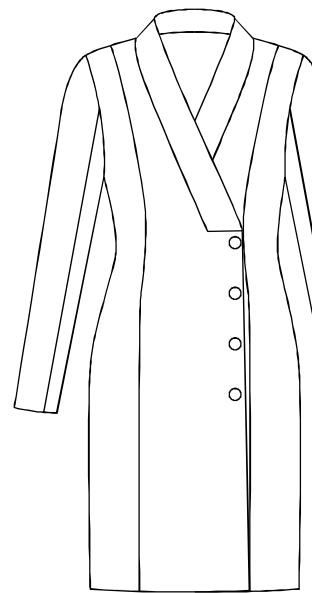

(7,3)

lBa

3

erials.tell4all.ru

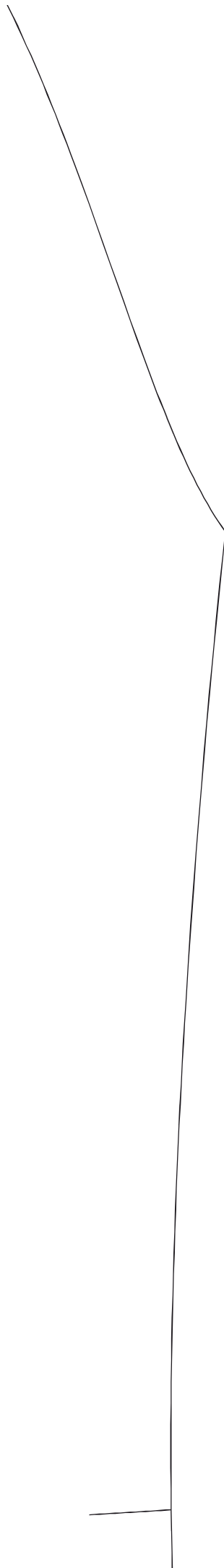
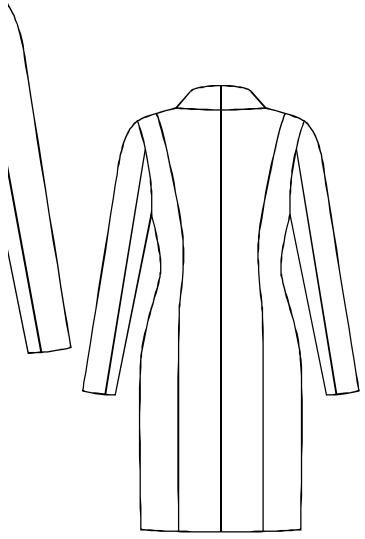

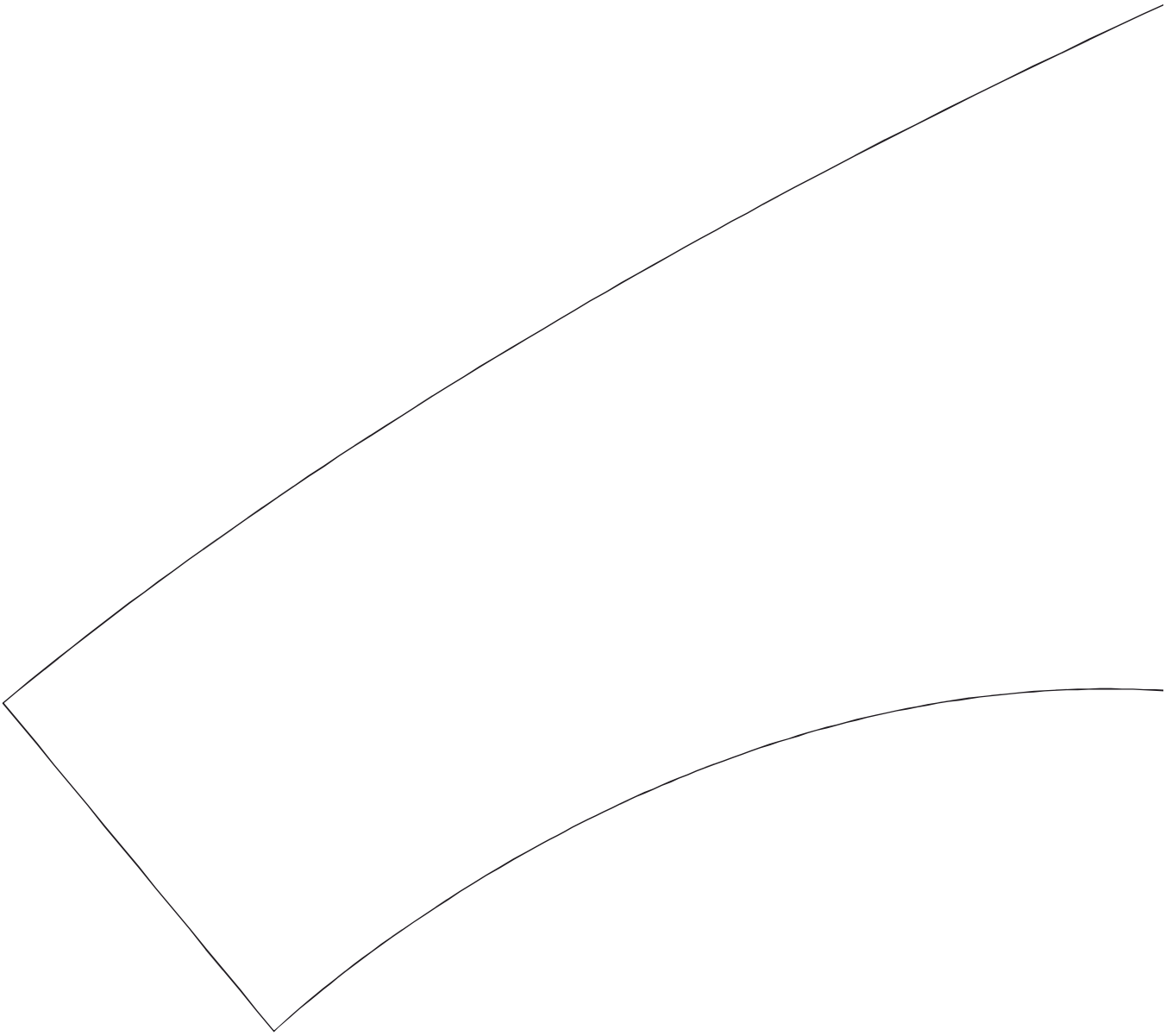

бочок переда

Размер 58
<http://materials.tell4all.ru>

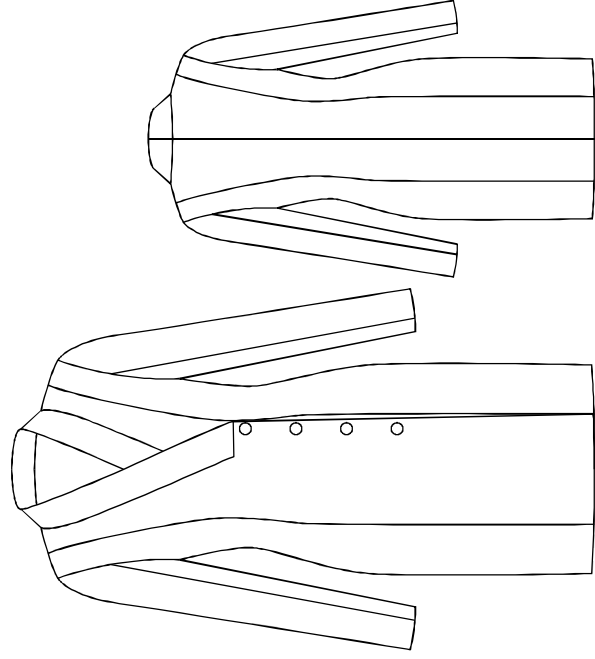

(3, 4)

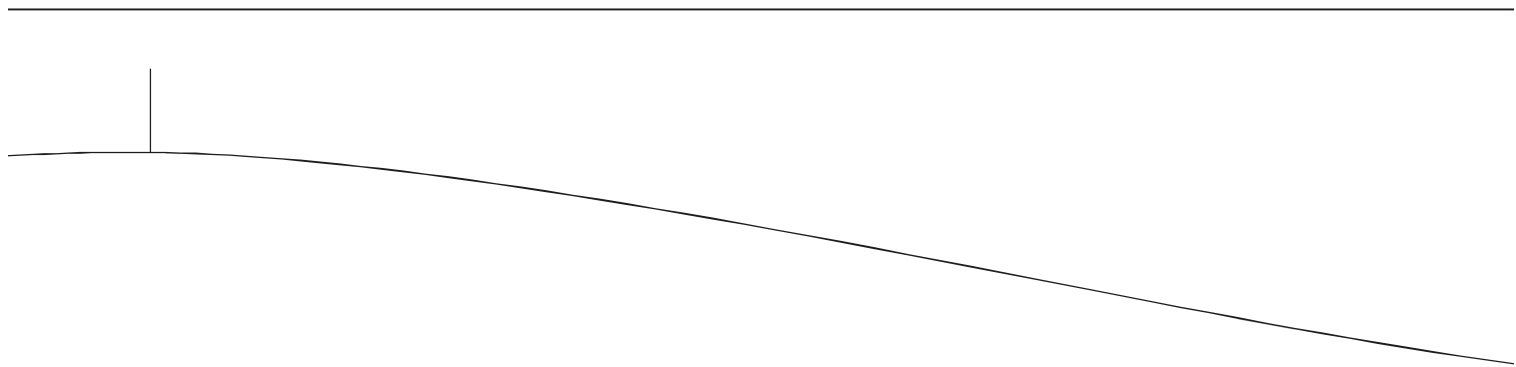
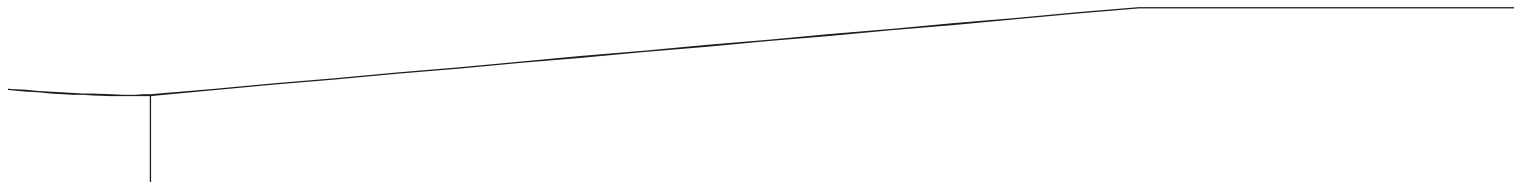

T

T

(4, 4)



T

T

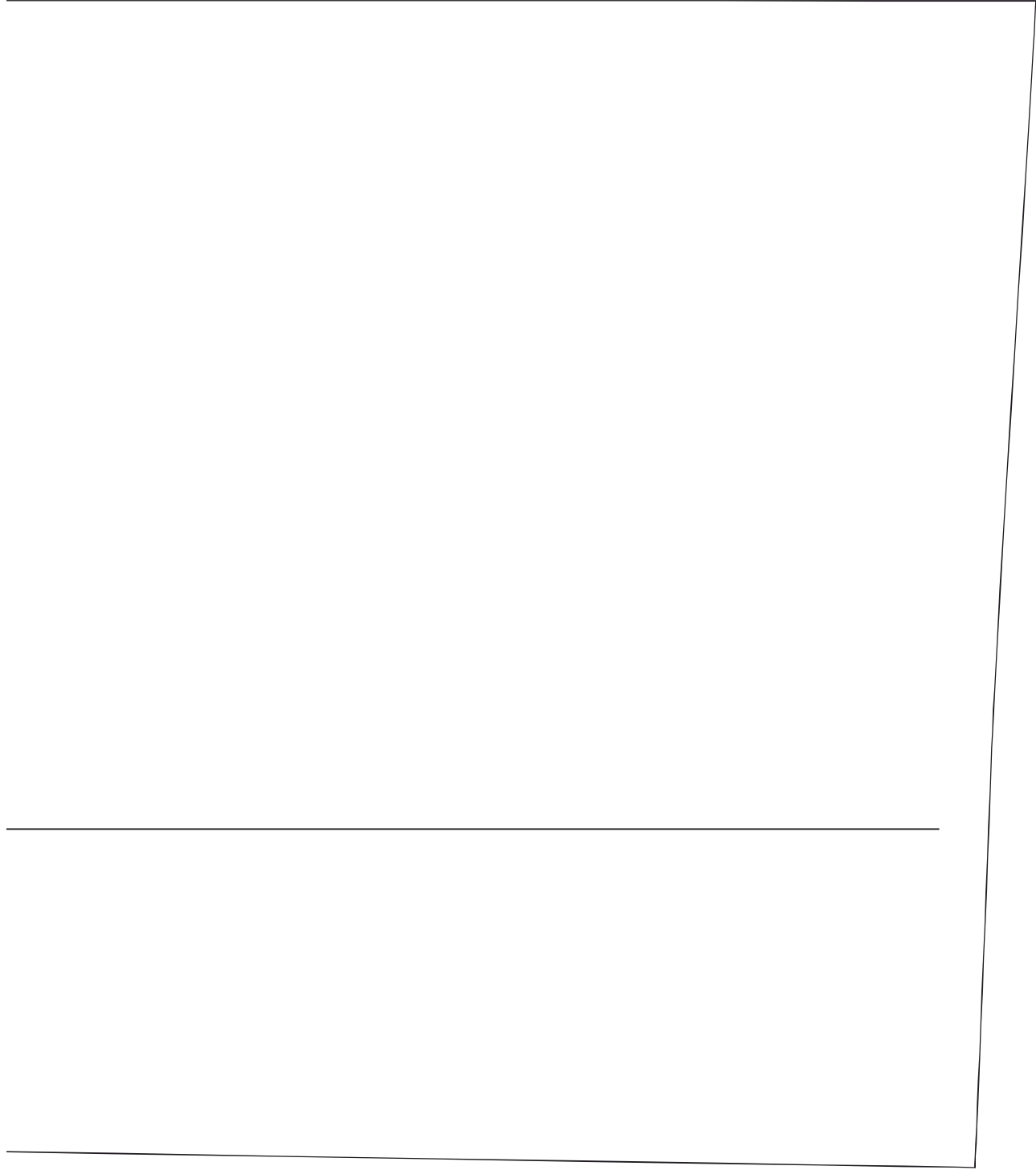

(6, 4)

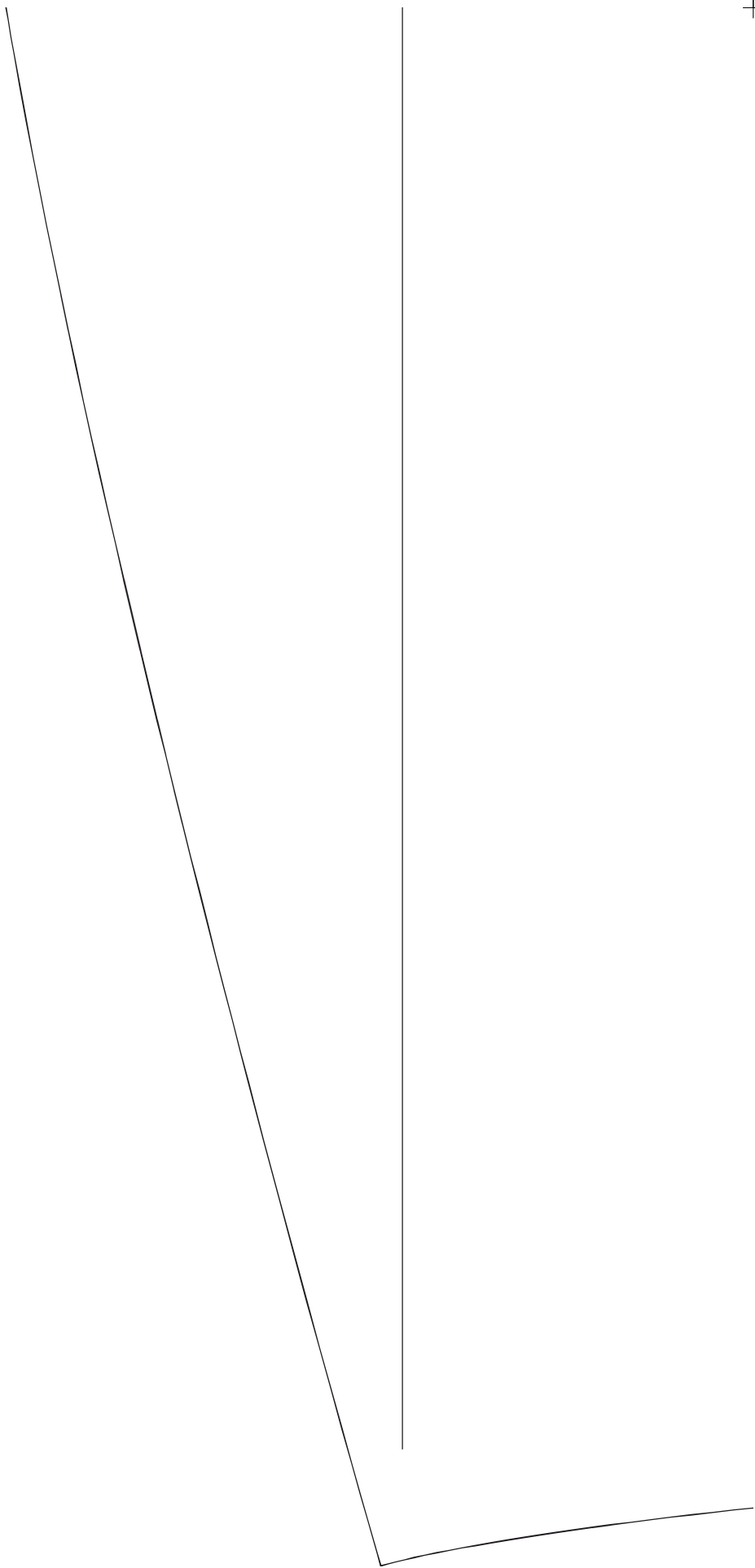

T

T

(7, 4)

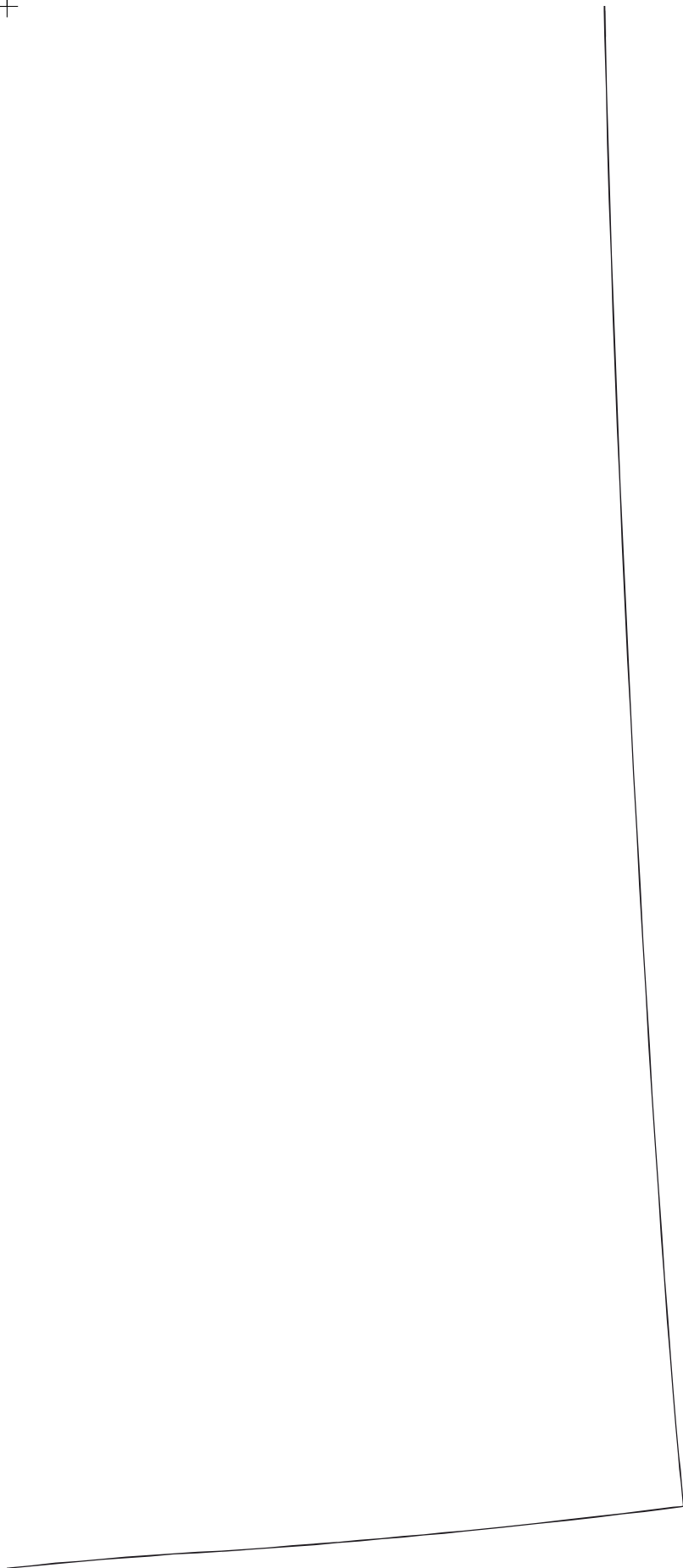

T

T