

5x5 cm

test

ROZWIĄZANIE!

str. 44

44

kolumna 1 wiersz 1

WYSCZEP

1

przód

kolumna 1 wiersz 2

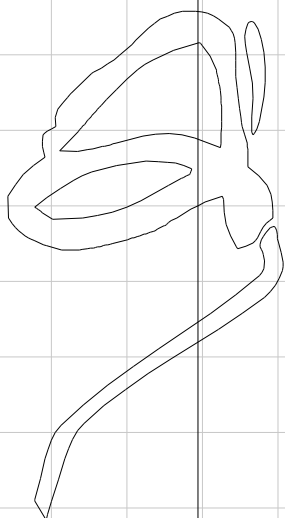

nitka prosta

kolumna 1 wiersz 3

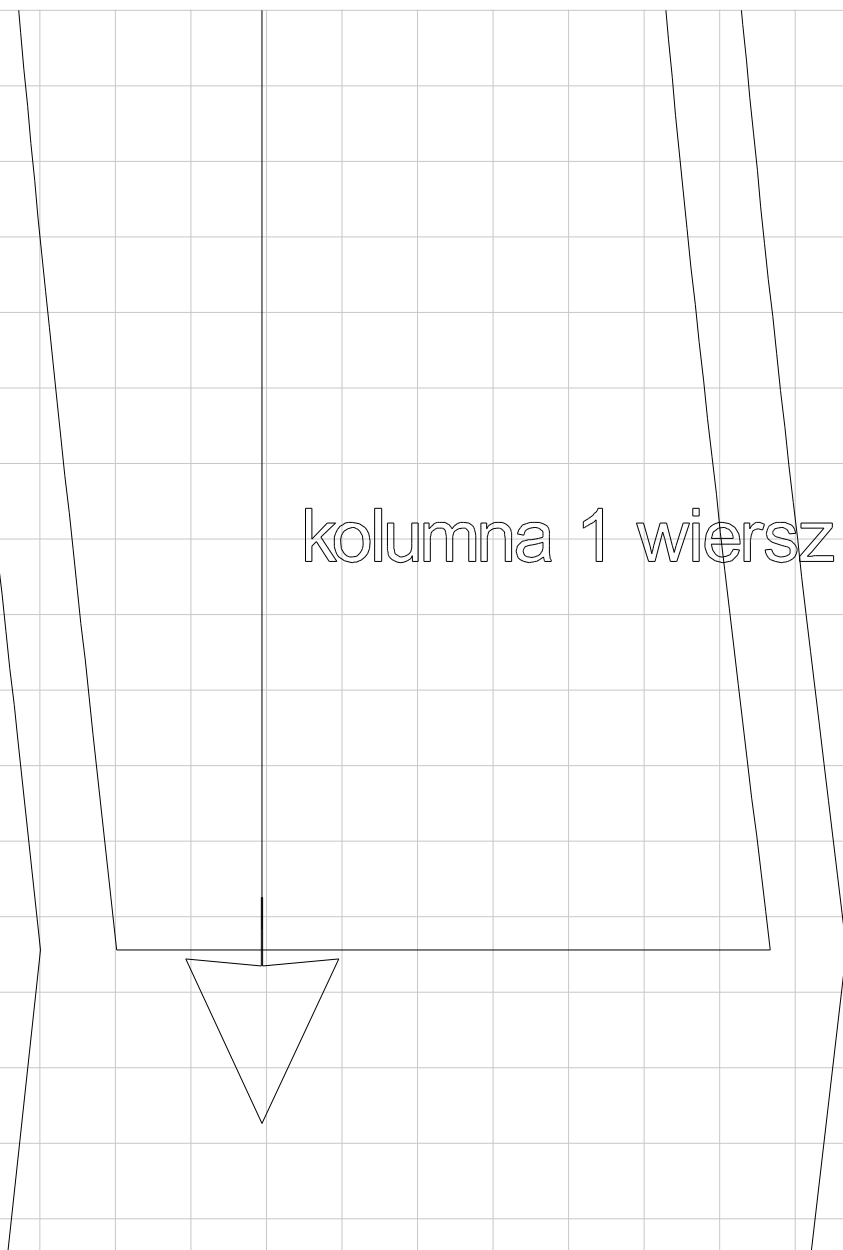

kolumna 1 wiersz 4

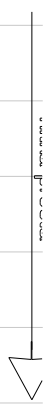
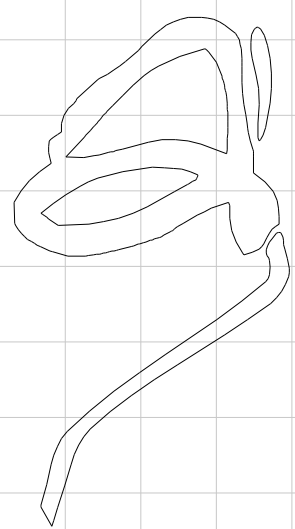

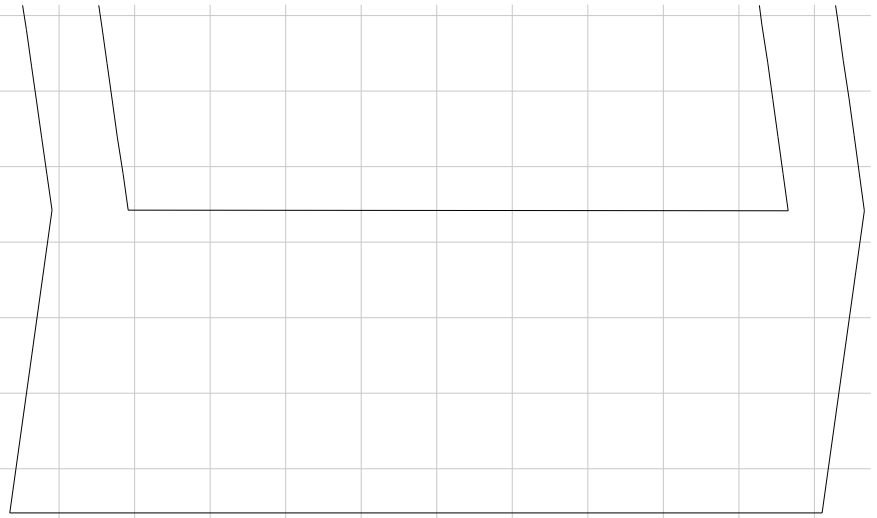

kolumna 1 wiersz 5

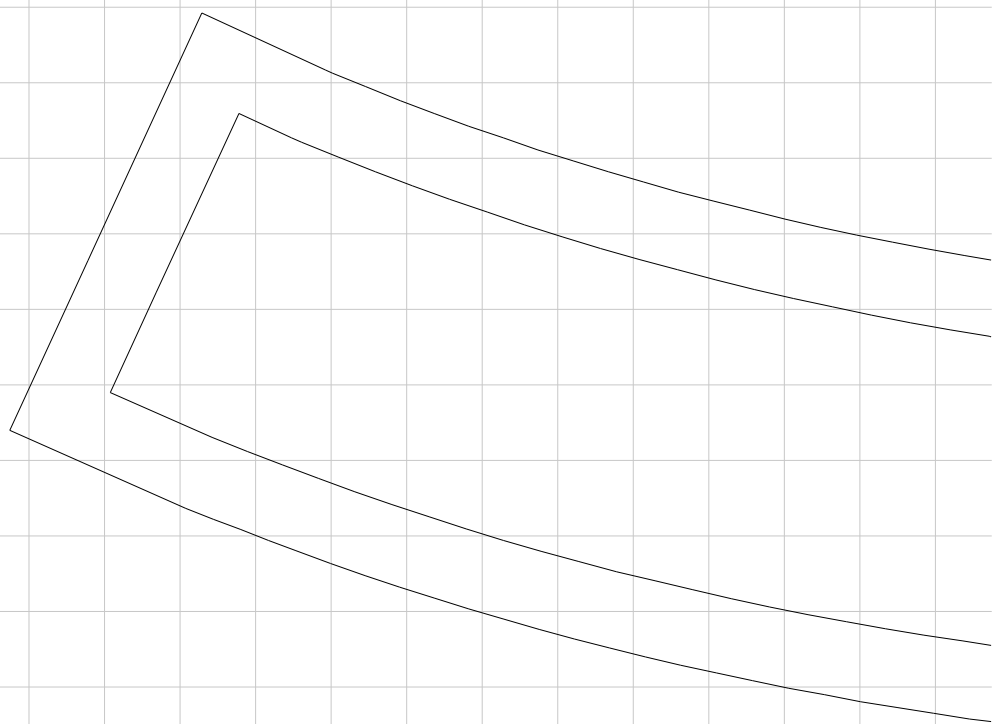

kolumna 2 wiersz 1

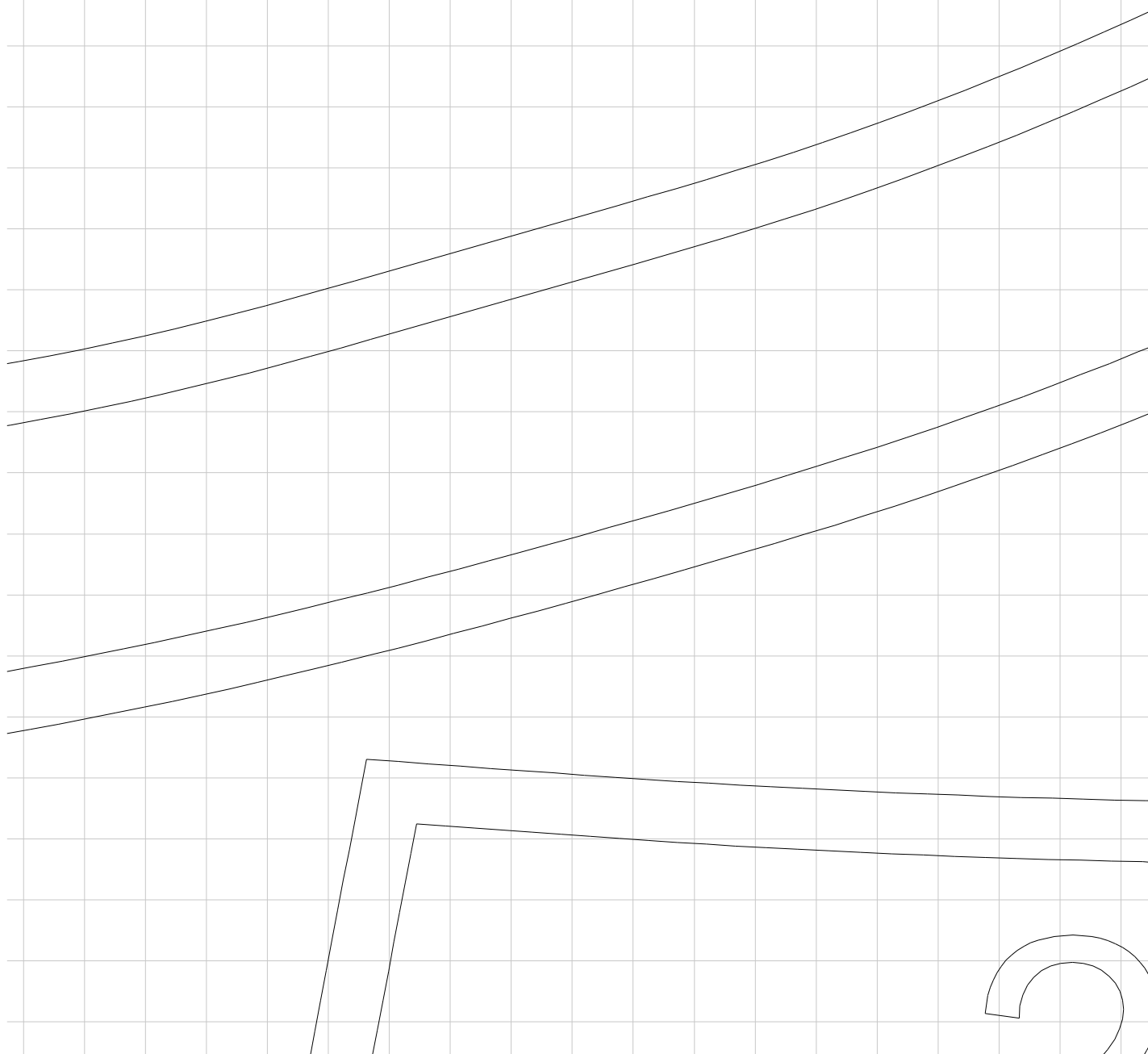

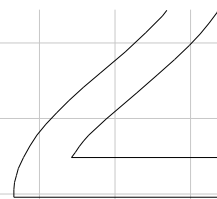

przód

kolumna 2 wiersz 2

A grid of 15 columns and 25 rows. A large, irregular polygon is drawn with black lines. The polygon has a top edge that is slightly concave, a bottom edge that is slightly convex, and a central horizontal section that is wider than the top and bottom sections. The text 'kolumna 2 wiersz 3' is centered within the polygon.

kolumna 2 wiersz 3



nitka prosta

7

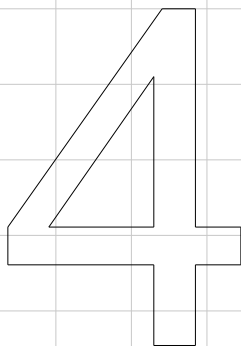

*przód*

www.papc  
kolumna 2 wiersz 4

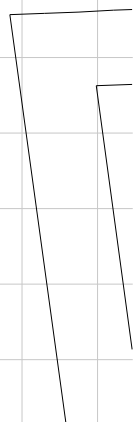
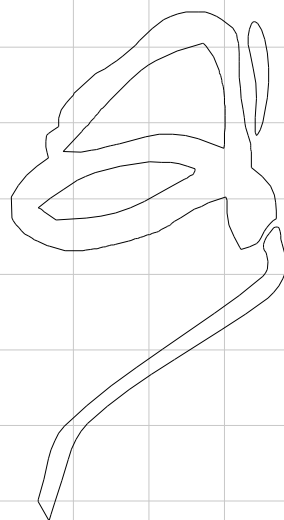

kolumna 2 wiersz 5

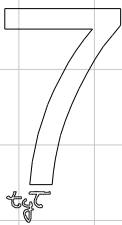

kolumna 3 wiersz 1

22



kolumna 3 wiersz 2

nitka pr

osta

kolumna 3 wiersz 3

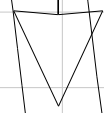

avero.pl  
kolumna 3 wiersz 4

5  
przód

nitka prosta  
↓

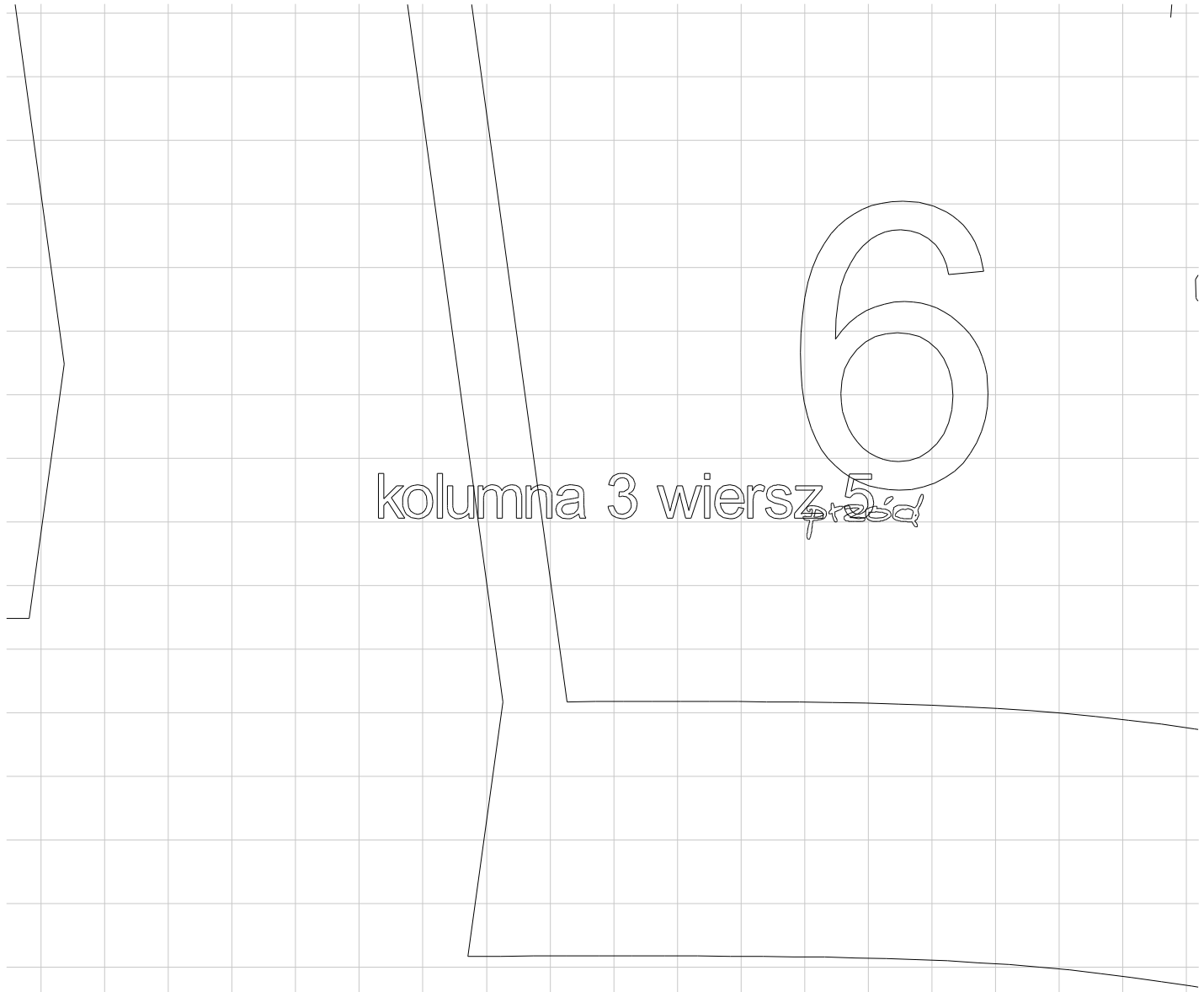

kolumna 3 wiersz 5  
przed

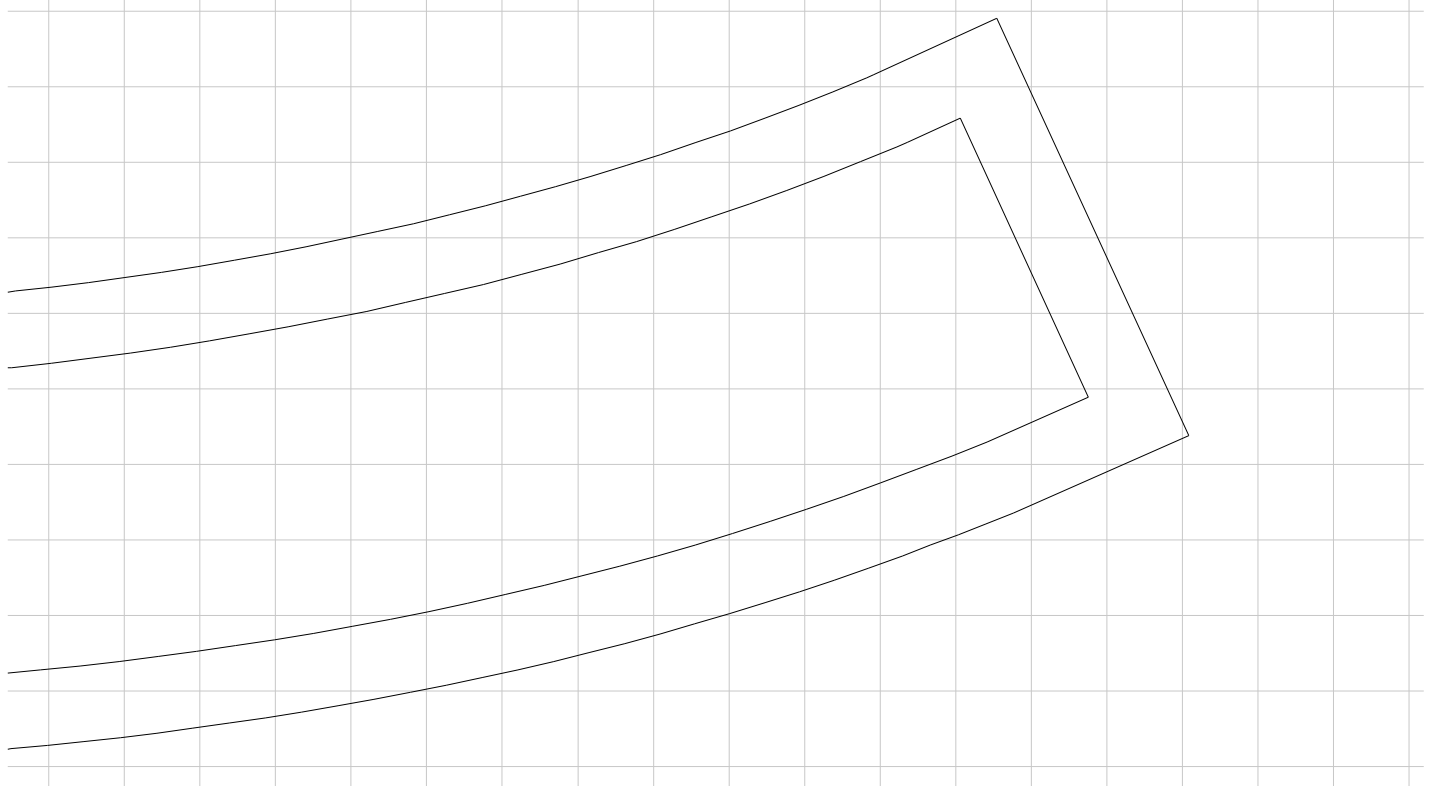

kolumna 4 wiersz 1

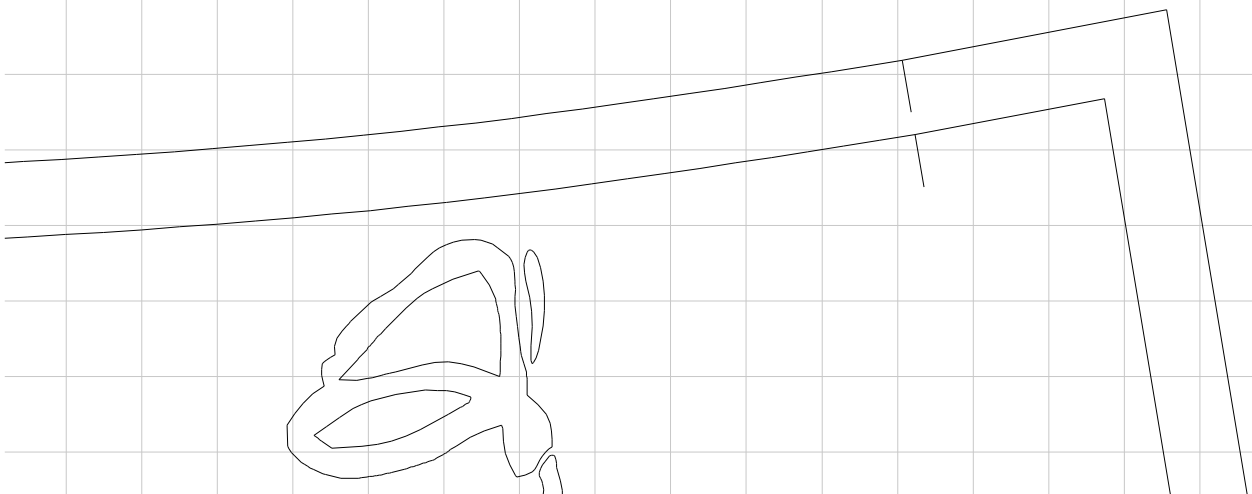



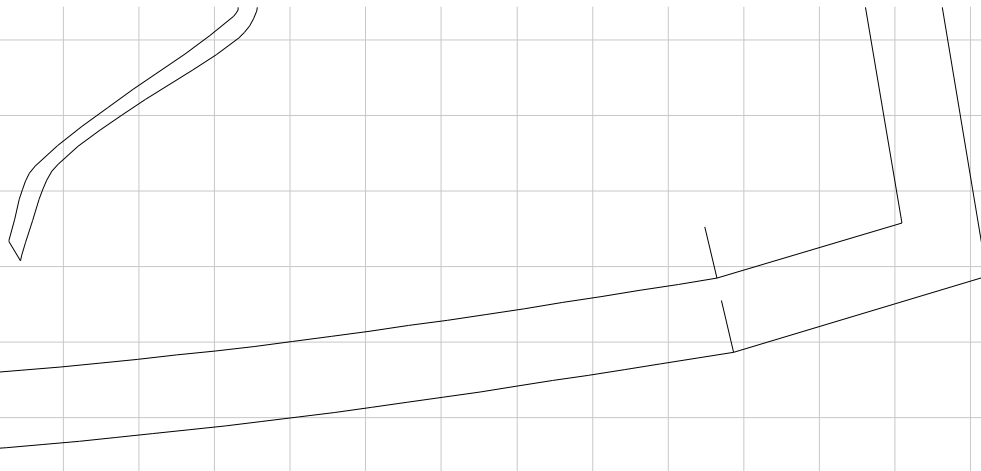

kolumna 4 wiersz 2

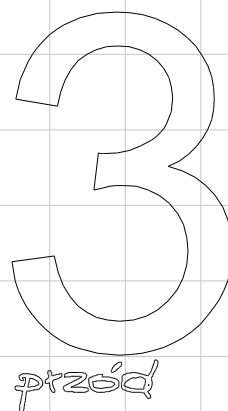

nitka prosta

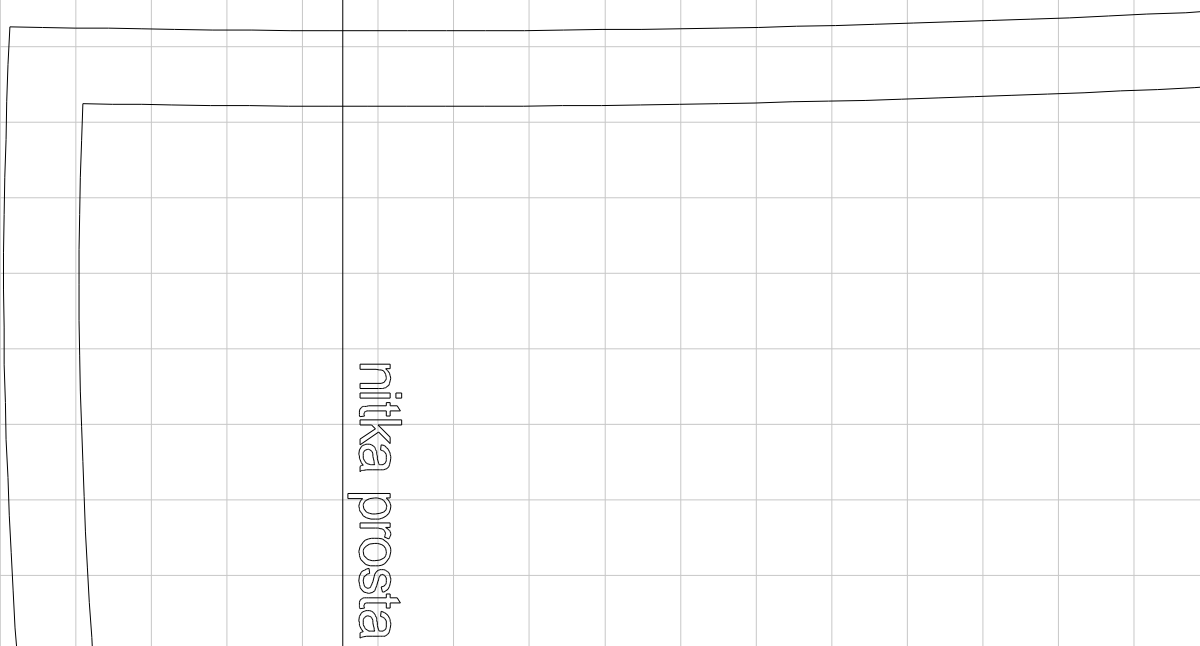

kolumna 4 wiersz 3

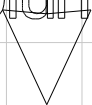

kolumna 4 wiersz 4

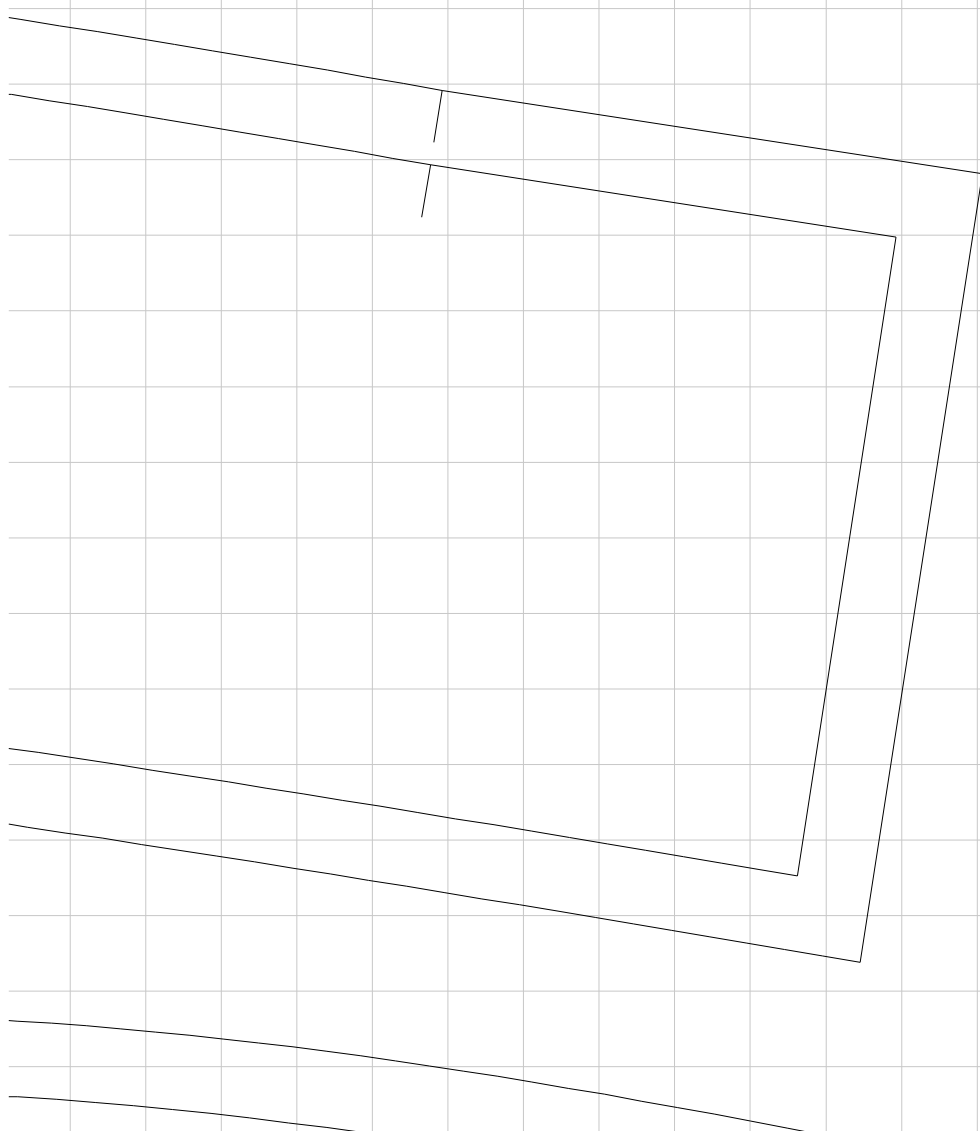

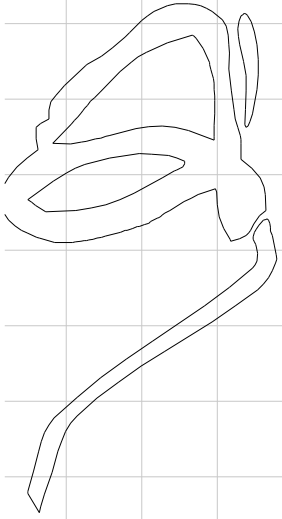

kolumna 4 wiersz 5

www.papave



kolumna 5 wiersz 2

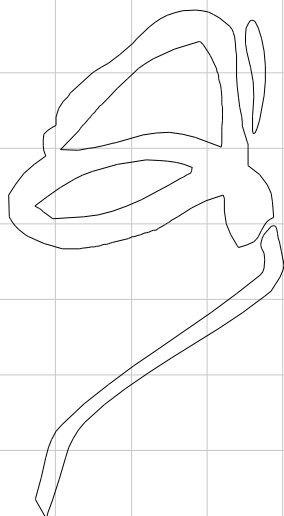

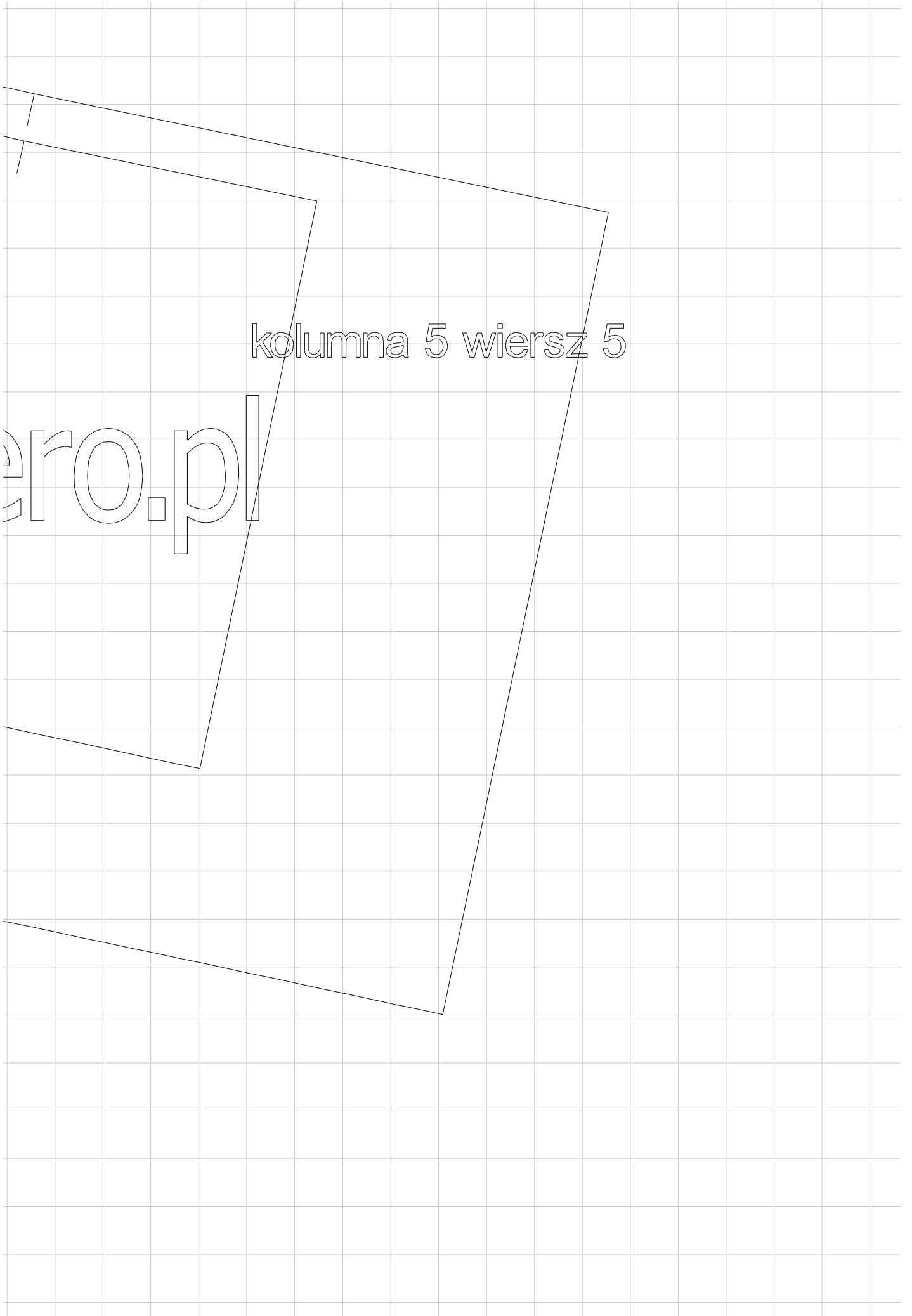

kolumna 5 wiersz 5

pro.pl

kolumna 6 wiersz 1

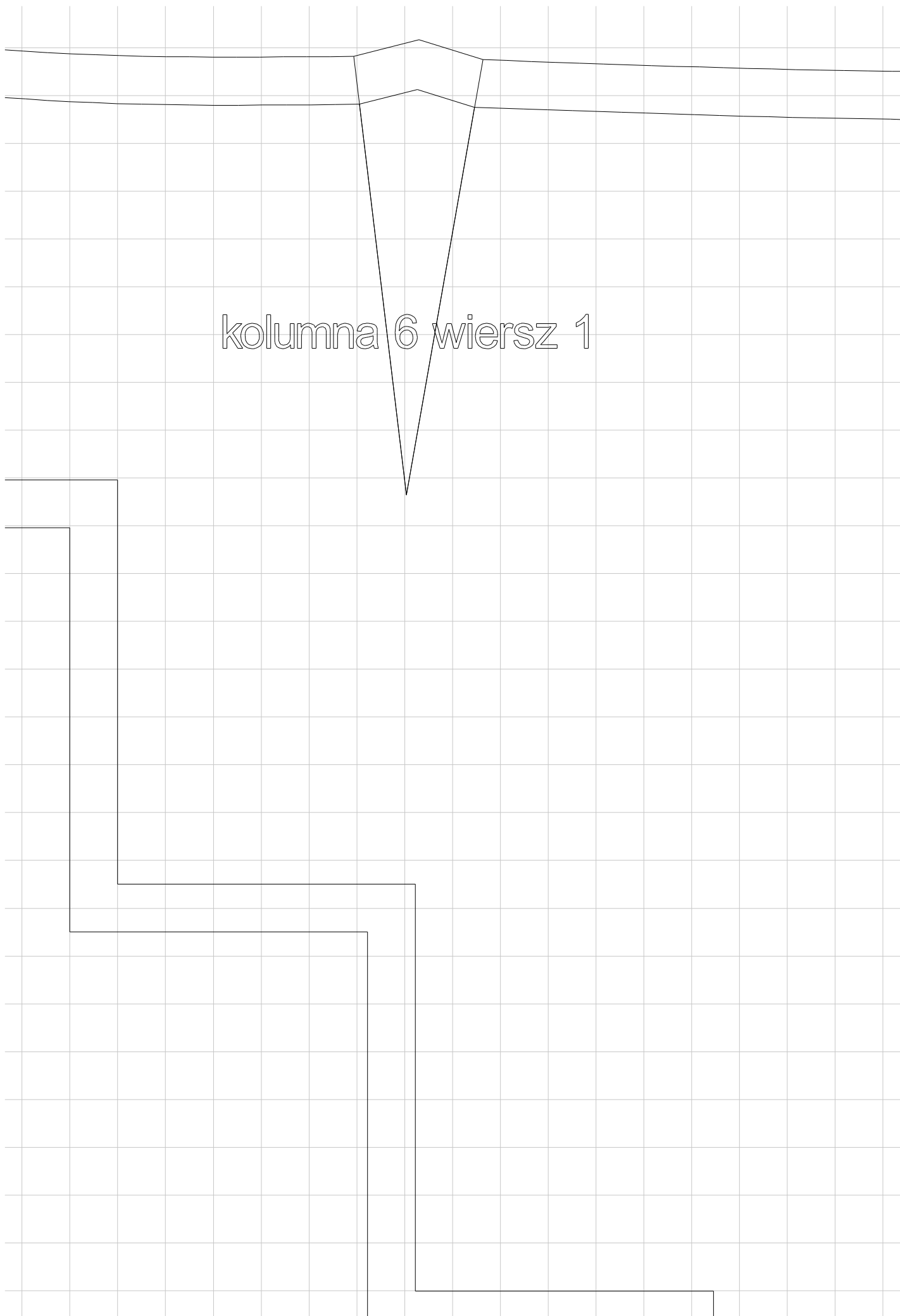





tyt  
8

kolumna 7 wiersz 1

nitka pr

WWW-portal

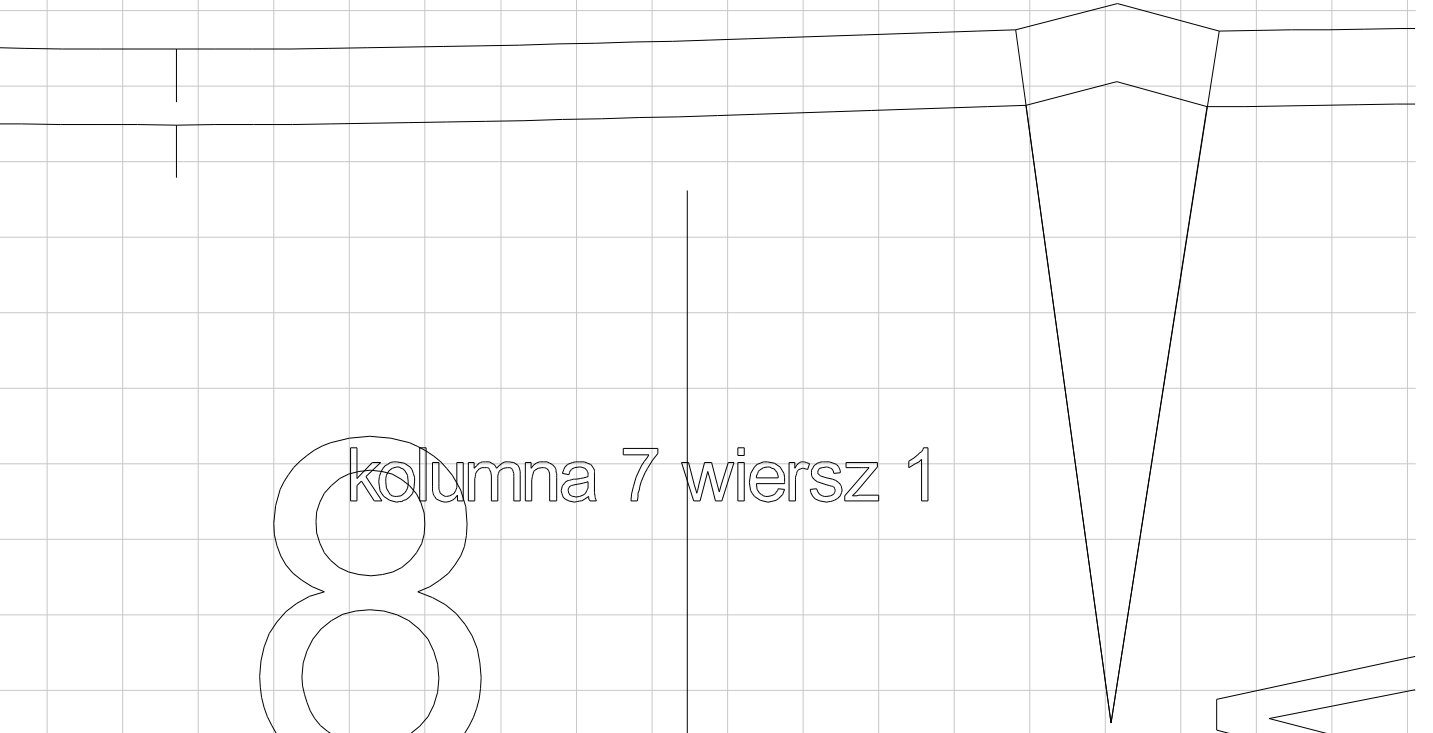



kolumna 8 wiersz 1

U  
U  
UU  
UU  
U  
UU  
UU  
U  
U  
UU  
UU  
UU

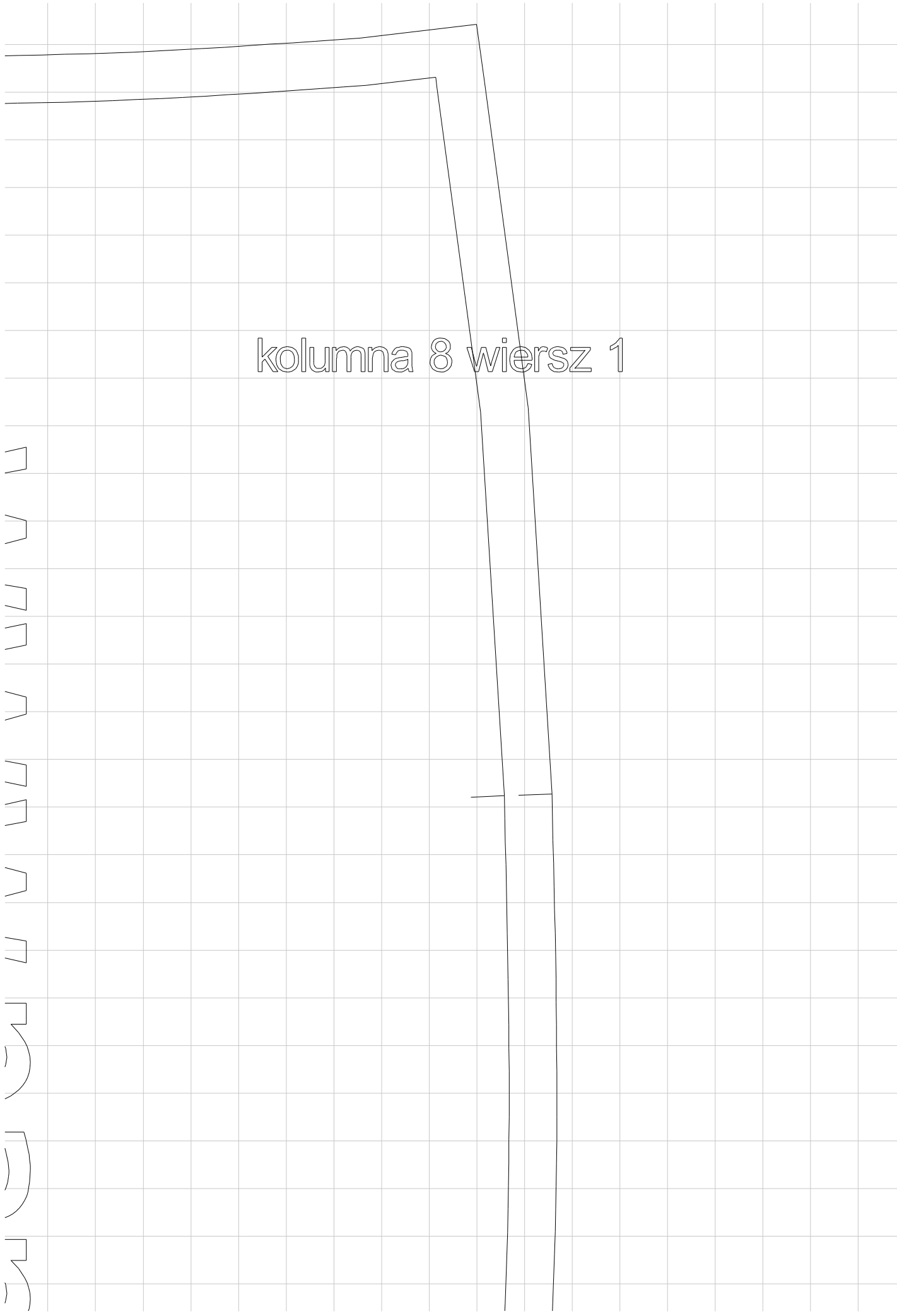

kolumna 8 wiersz 2

