

5x5 cm

test

ROZWIĄZANIE

kolumna 1 wiersz 1

WYSCOTTIO

str. 52

1

przód

kolumna 1 wiersz 2

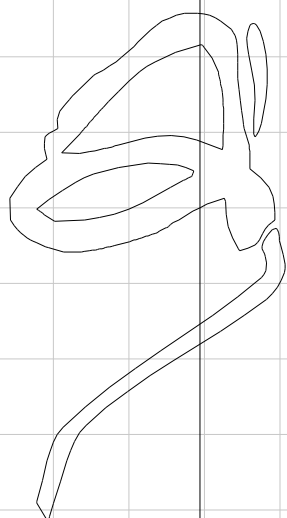

nitka prosta

kolumna 1 wiersz 3

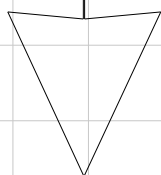

kolumna 1 wiersz 4

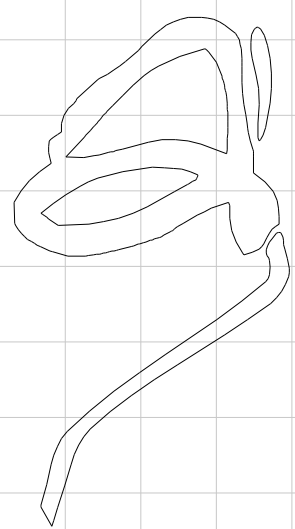

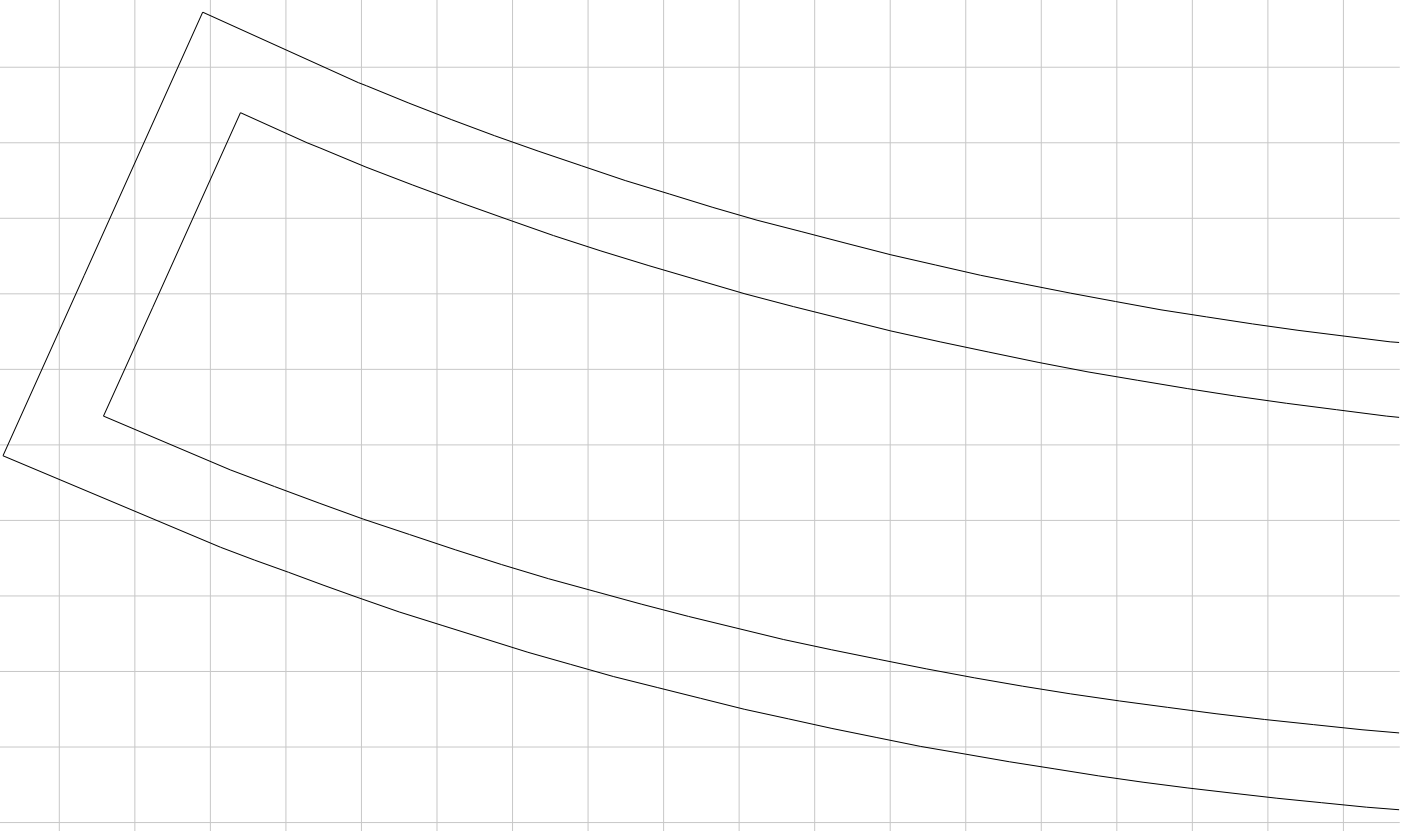
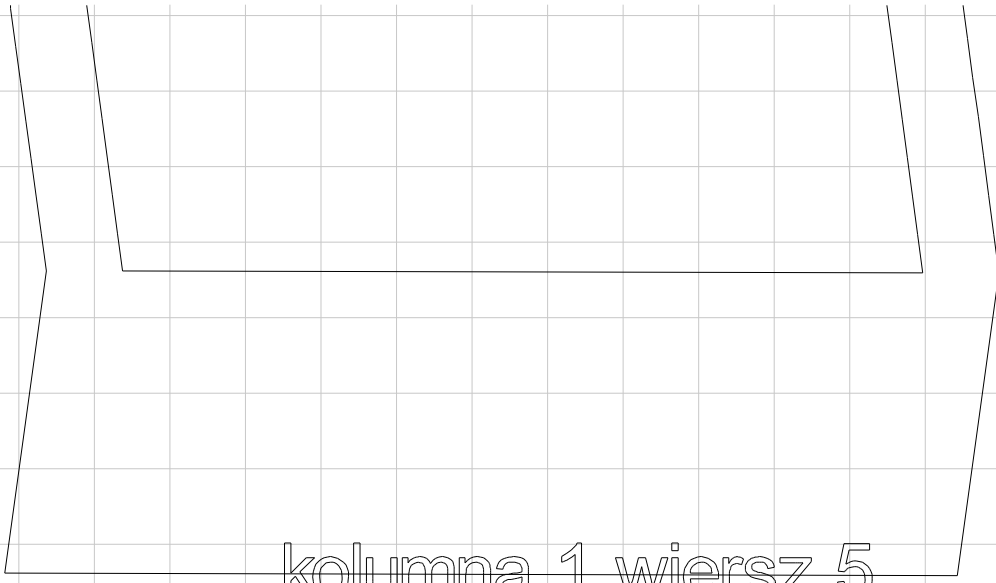

kolumna 2 wiersz 1

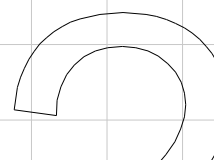

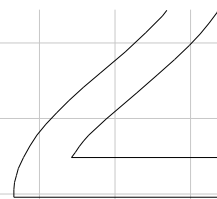

przód

kolumna 2 wiersz 2

kolumna 2 wiersz 3

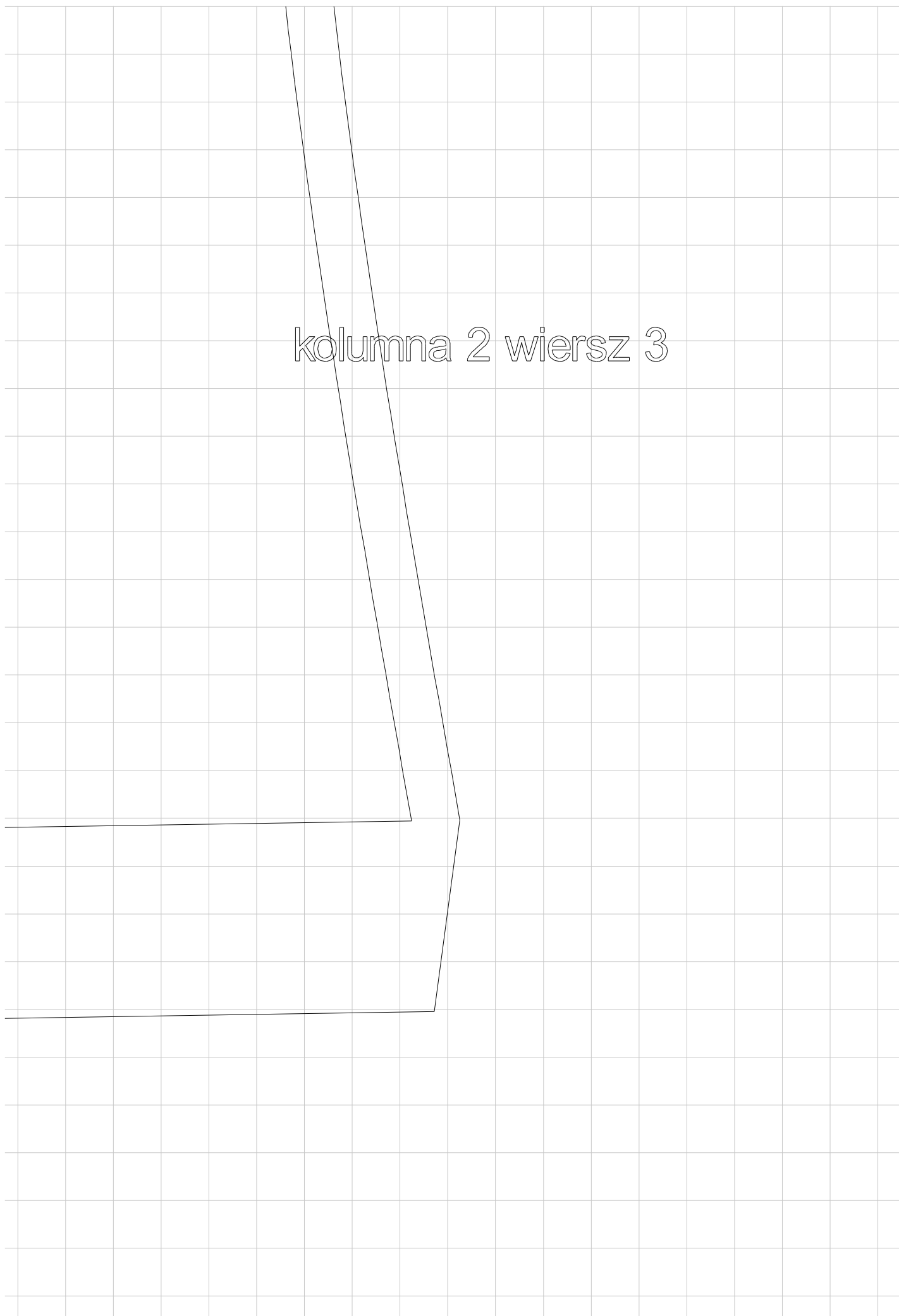

nitka prosta

7

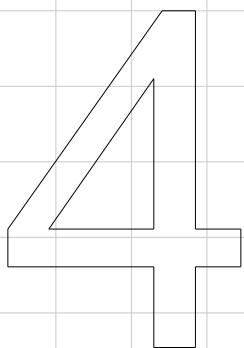

przód

www.papci
kolumna 2 wiersz 4

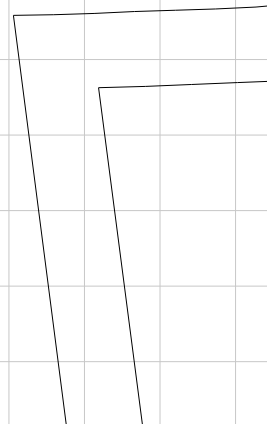
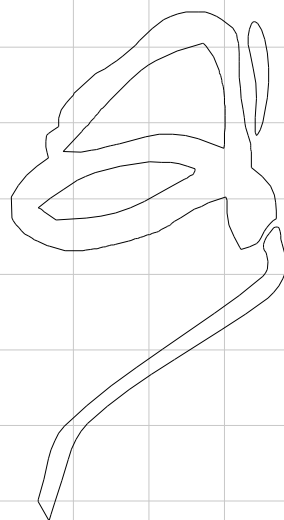

kolumna 2 wiersz 5

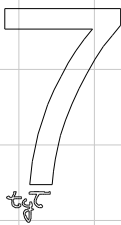

kolumna 3 wiersz 1

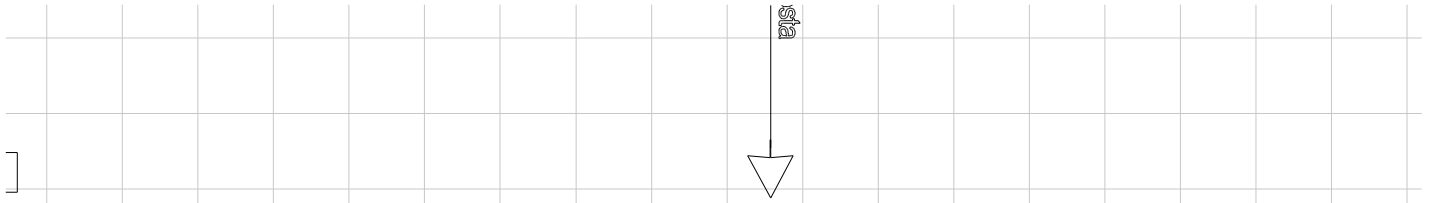

kolumna 3 wiersz 2

nitka pr

osta

kolumna 3 wiersz 3

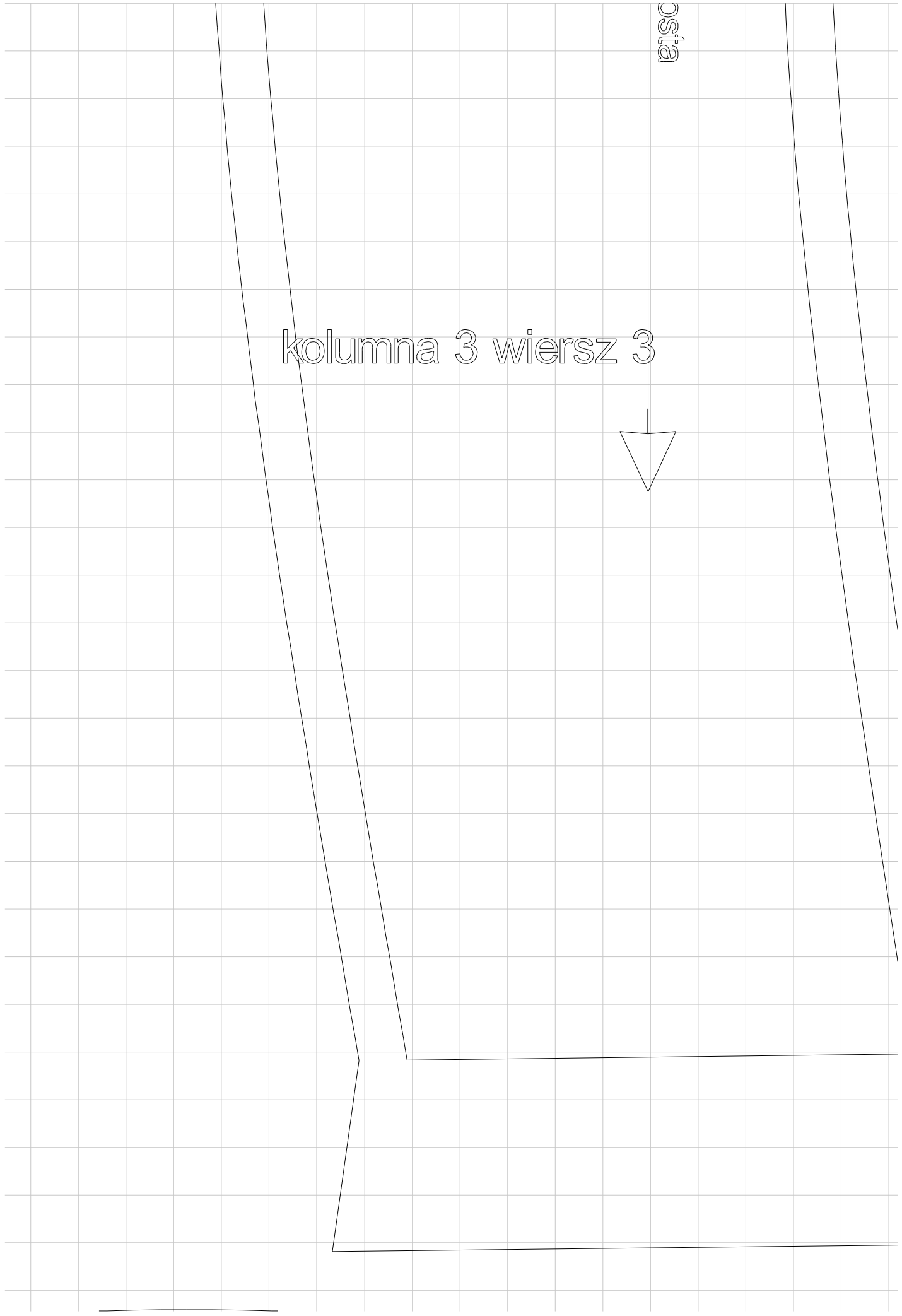
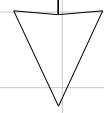

avero.pl

kolumna 3 wiersz 4

5
przód

nitka prosta
↓

6

kolumna 3 wiersz 5 przed

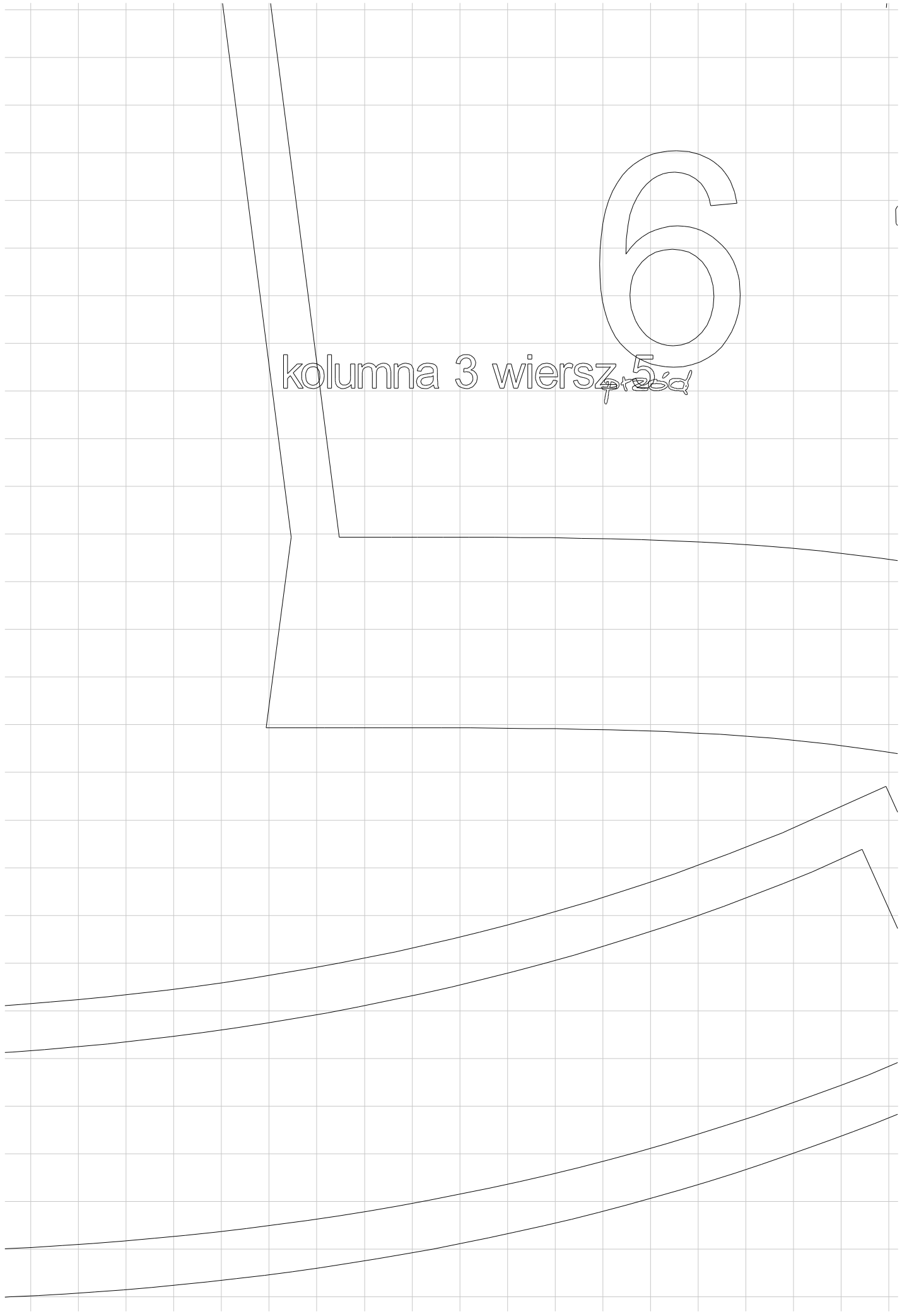

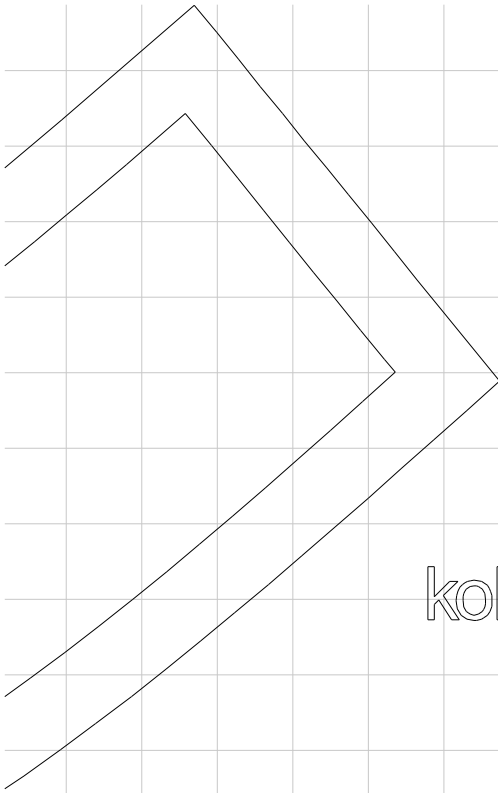

kolumna 4 wiersz 1

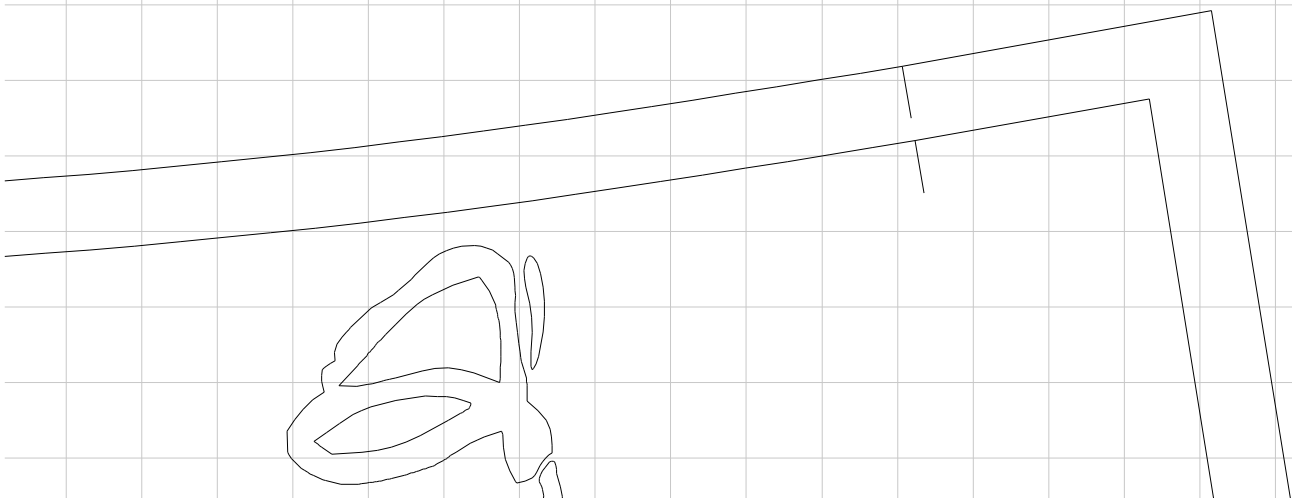

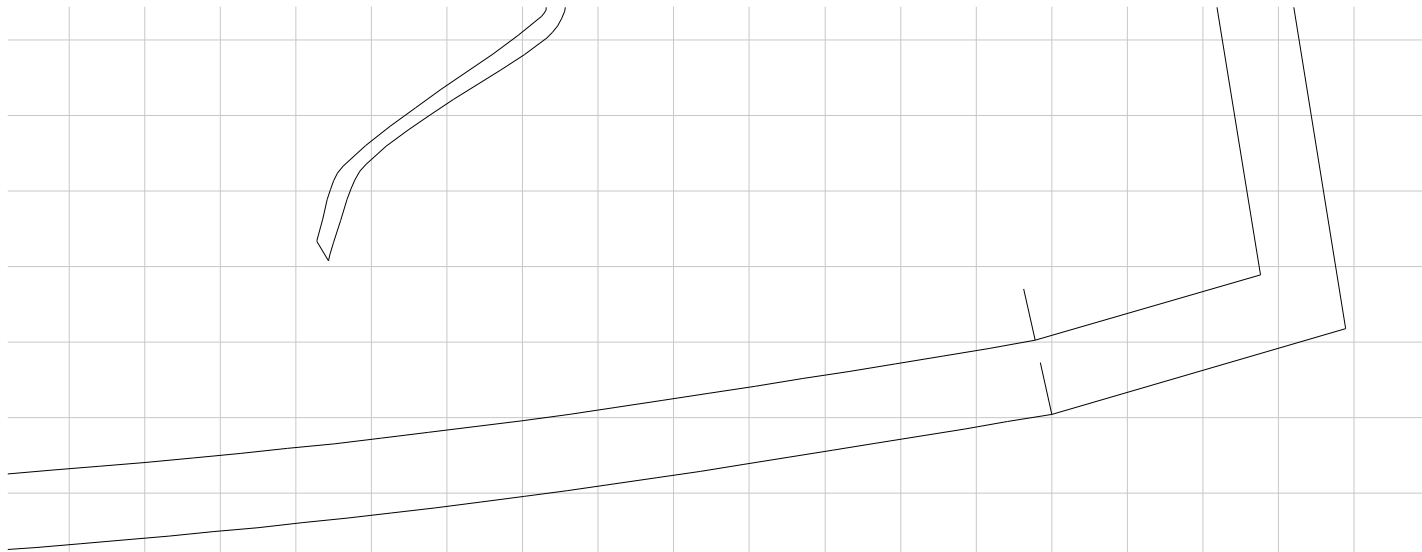
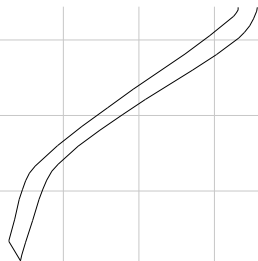

kolumna 4 wiersz 2

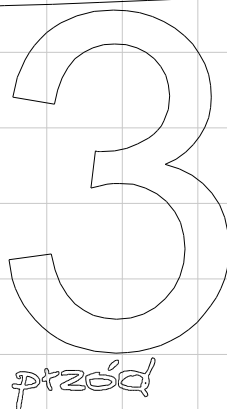

nitka prosta

kolumna 4 wiersz 3

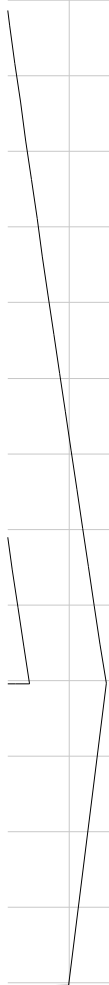
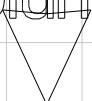

kolumna 4 wiersz 4

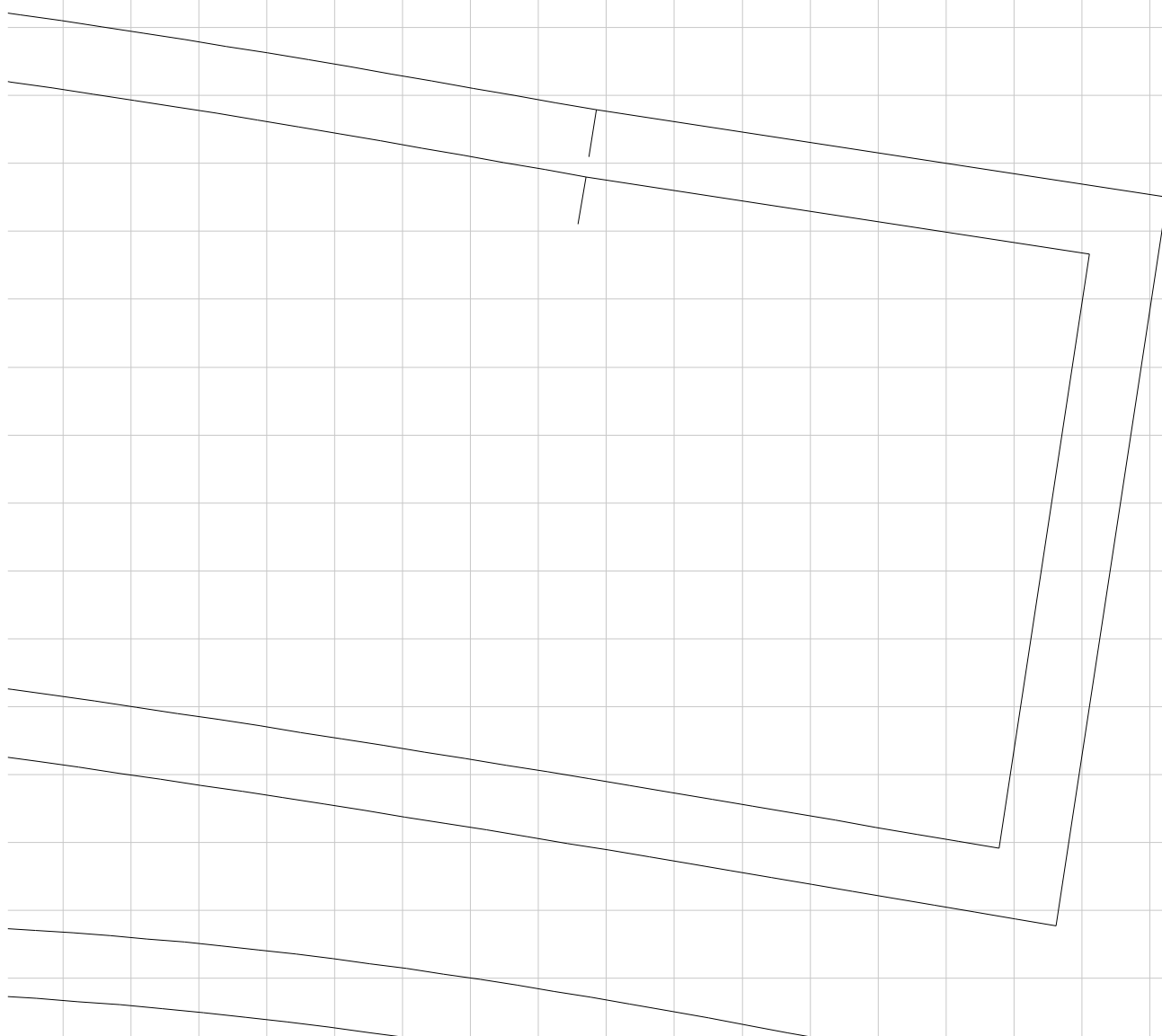

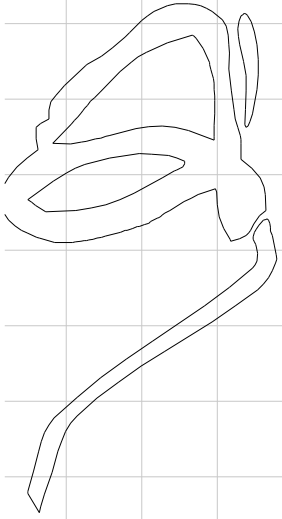

kolumna 4 wiersz 5

www.papave

kolumna 5 wiersz 1

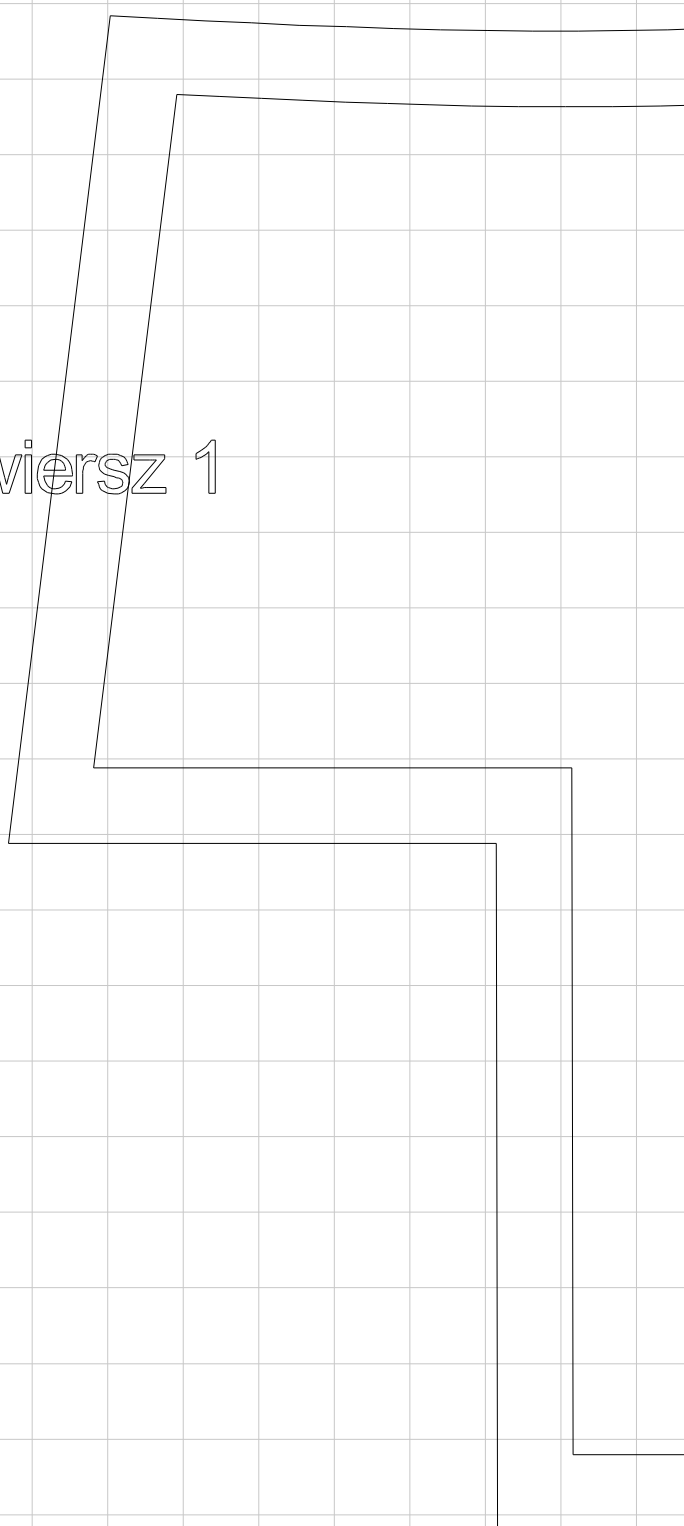

kolumna 5 wiersz 2

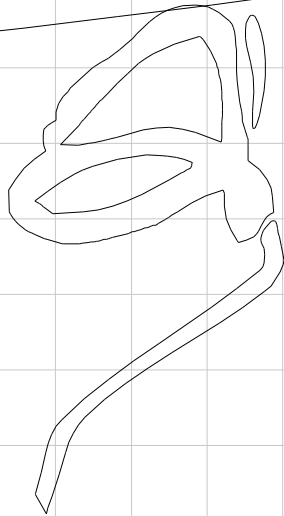

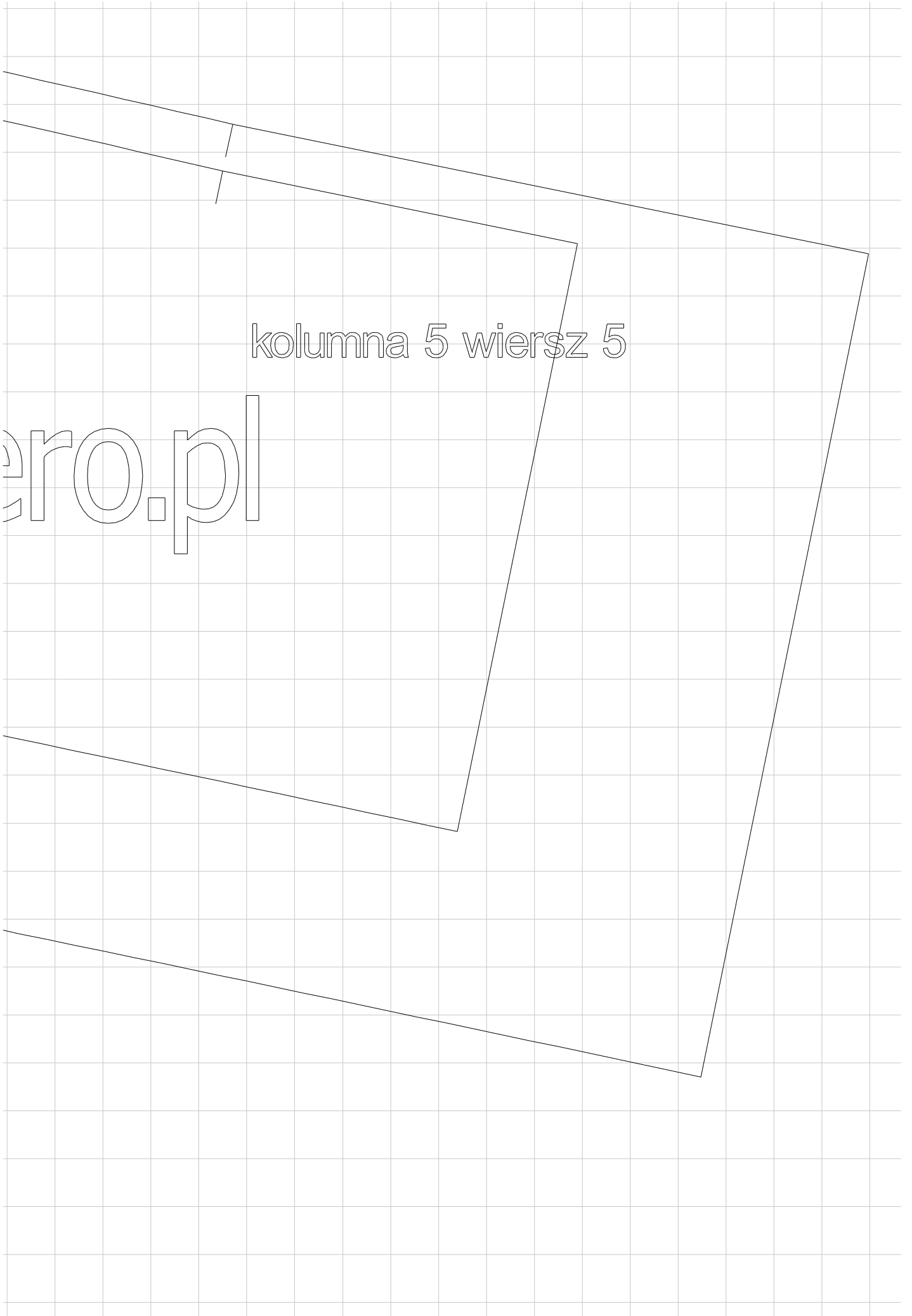

kolumna 5 wiersz 5

pro.pl



kolumna 6 wiersz 1

kolumna 6 wiersz 2

tyt

8

kolumna 7 wiersz 1

nitka pr

WWW.POLSKA

id.oci.oi

osta

kolumna 7 wiersz 2

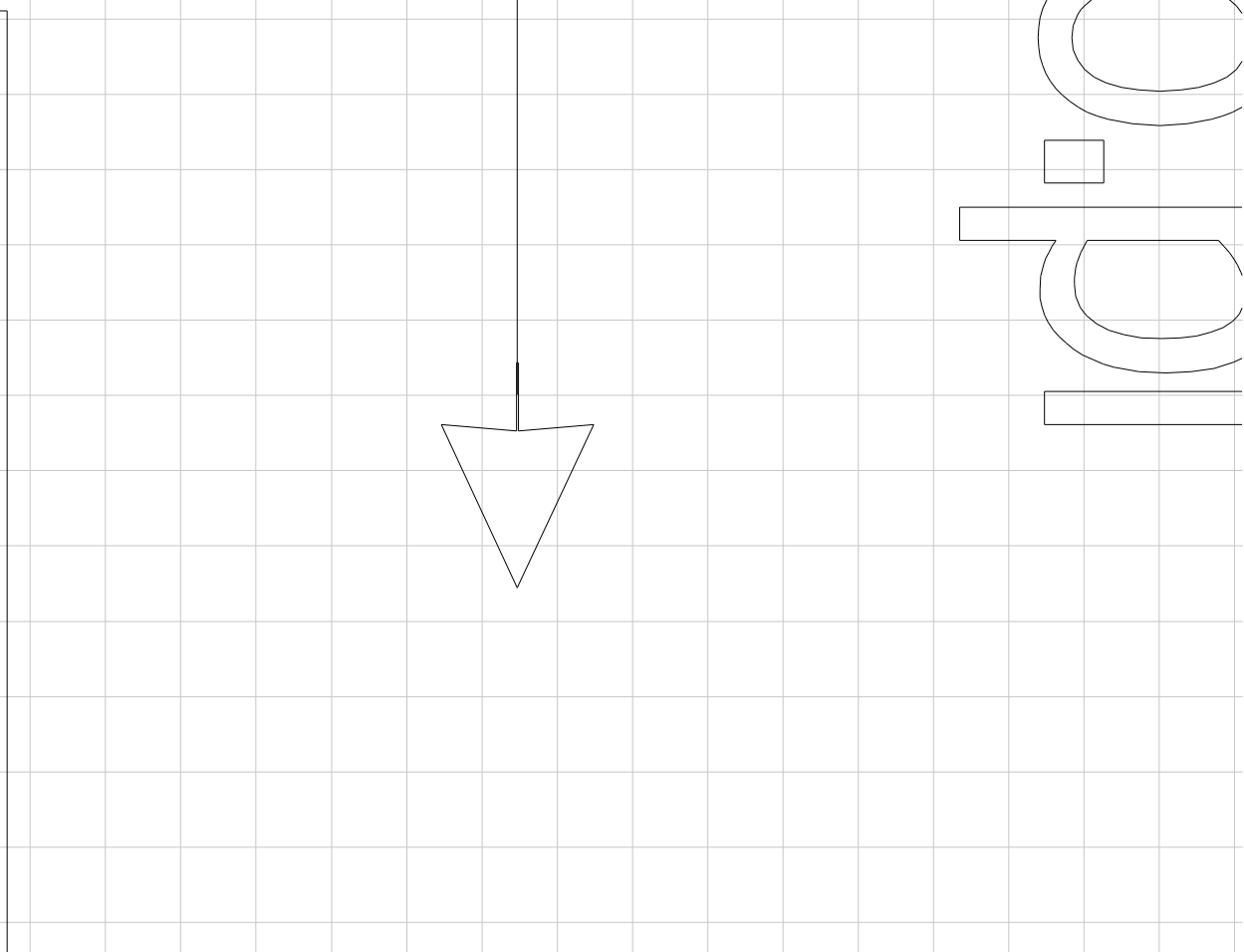
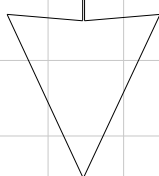

kolumna 8 wiersz 1

U
U
UU
UU
U
UU
UU
U
U
UU
UU
UU

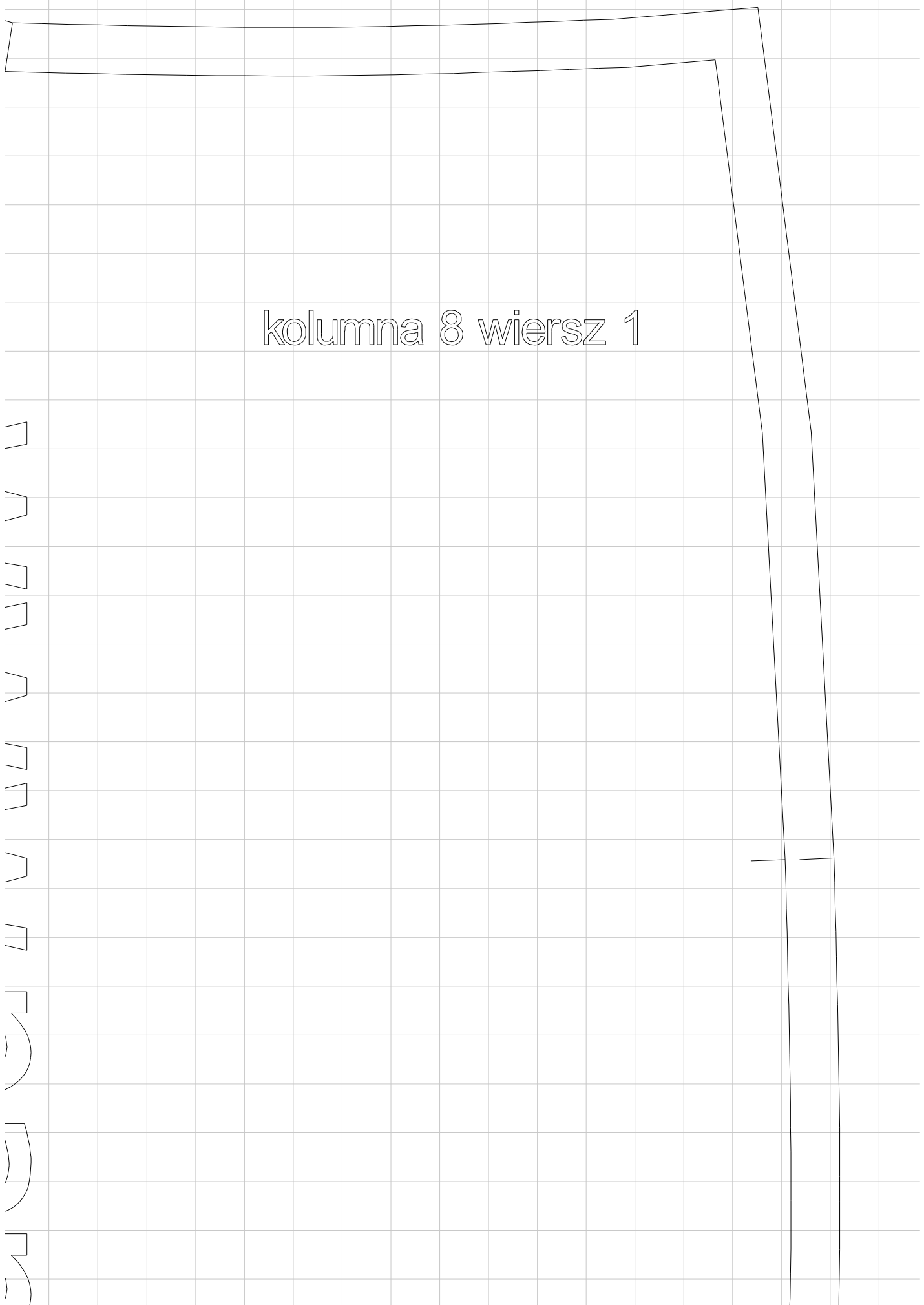

kolumna 8 wiersz 2

