

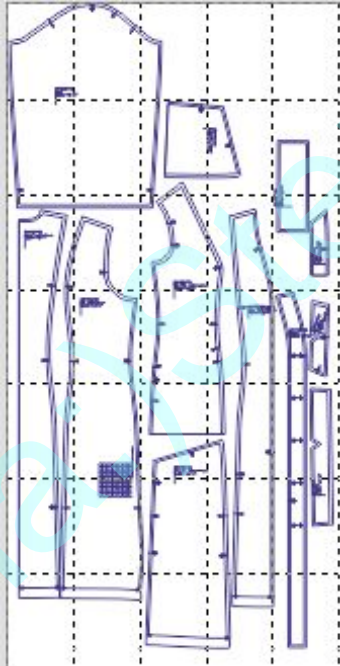

p.50

164-100-112

A-107



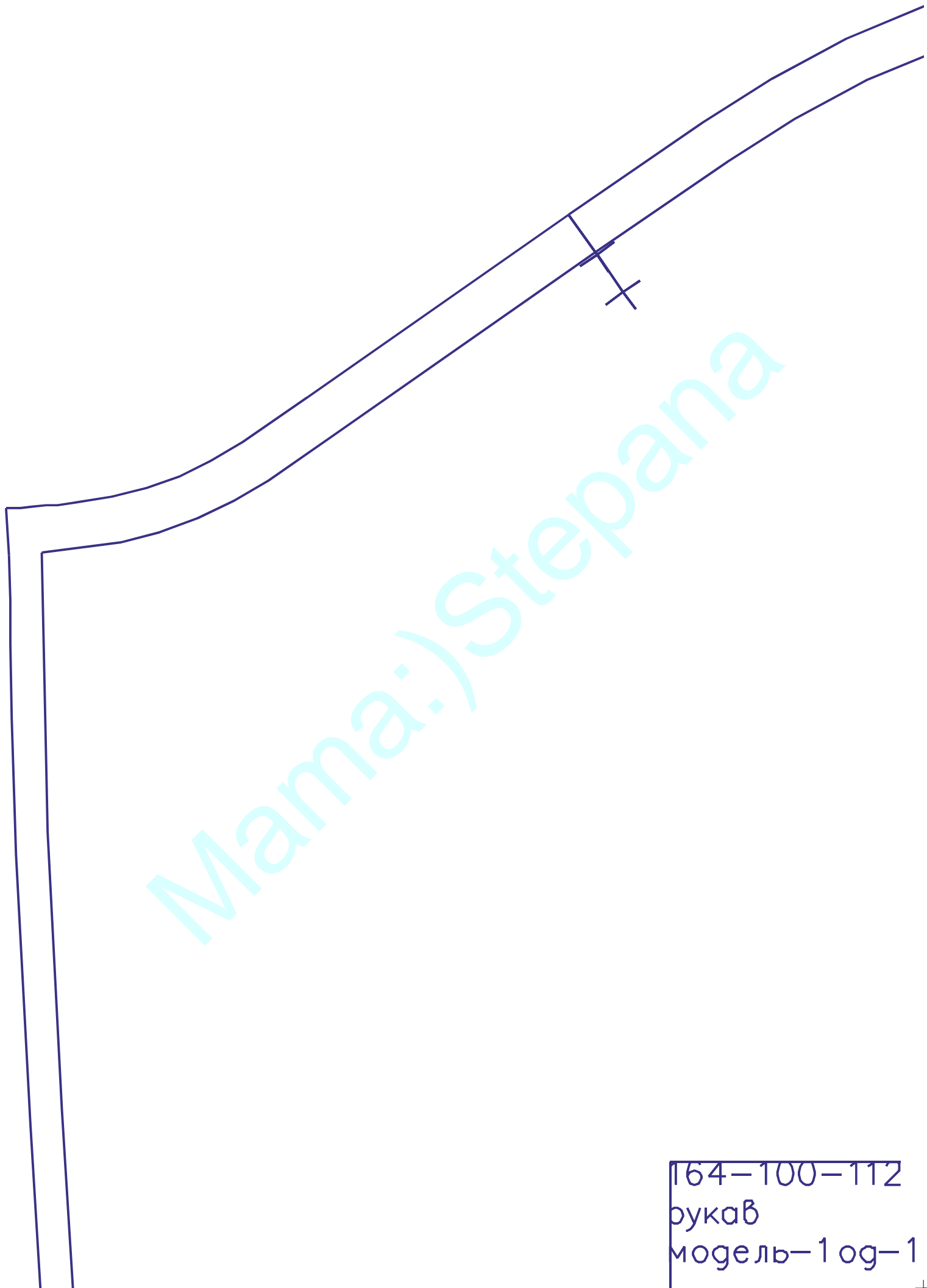

Мама:.)Stepana

164-100-112
рукав
модель-1 од-1

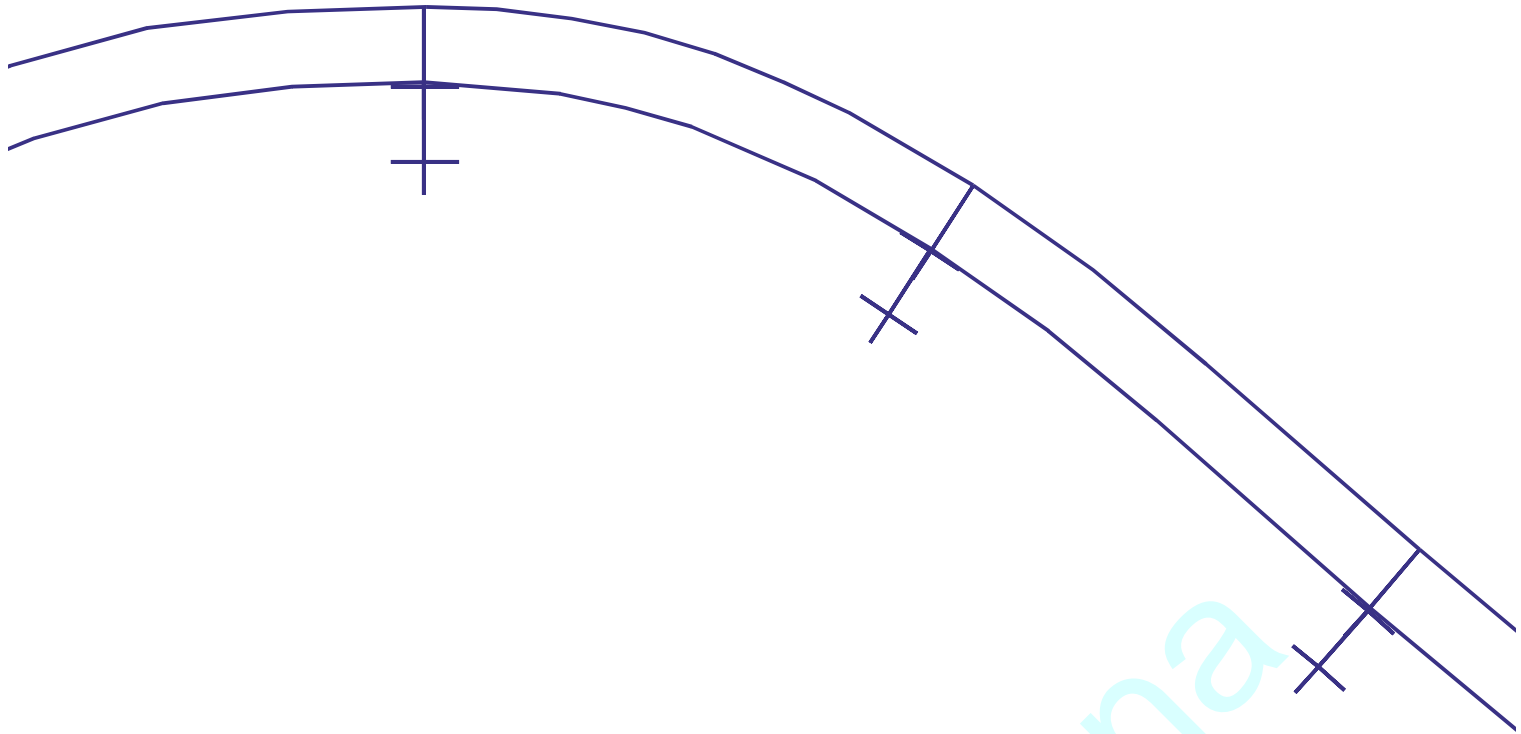

Mama:.)Stepana

Mama:;)Stepana

Mama:;)Stepana

Mama:;)Stepana

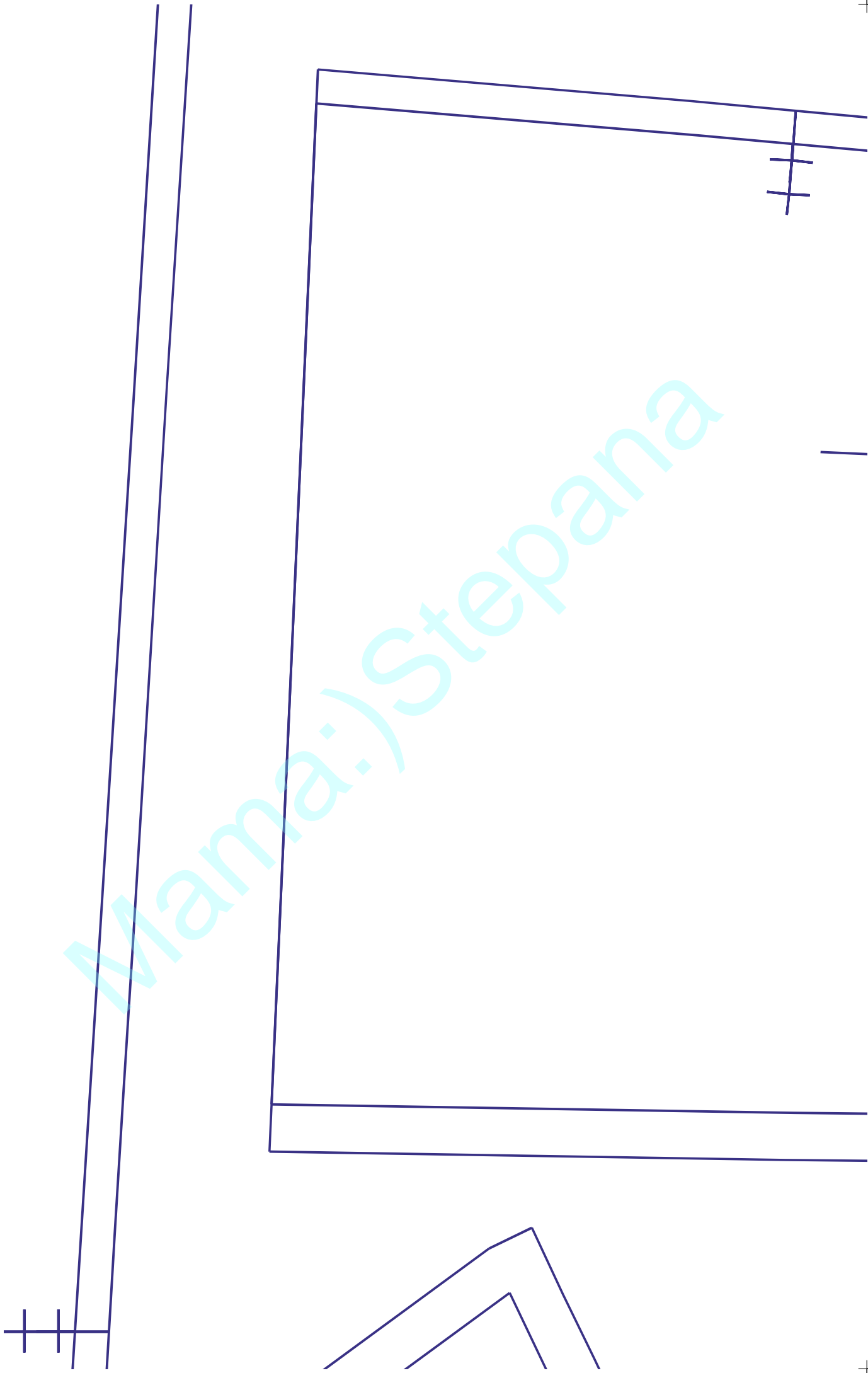

Mama :) Stepana

12

9-107

Mama:) Stepana

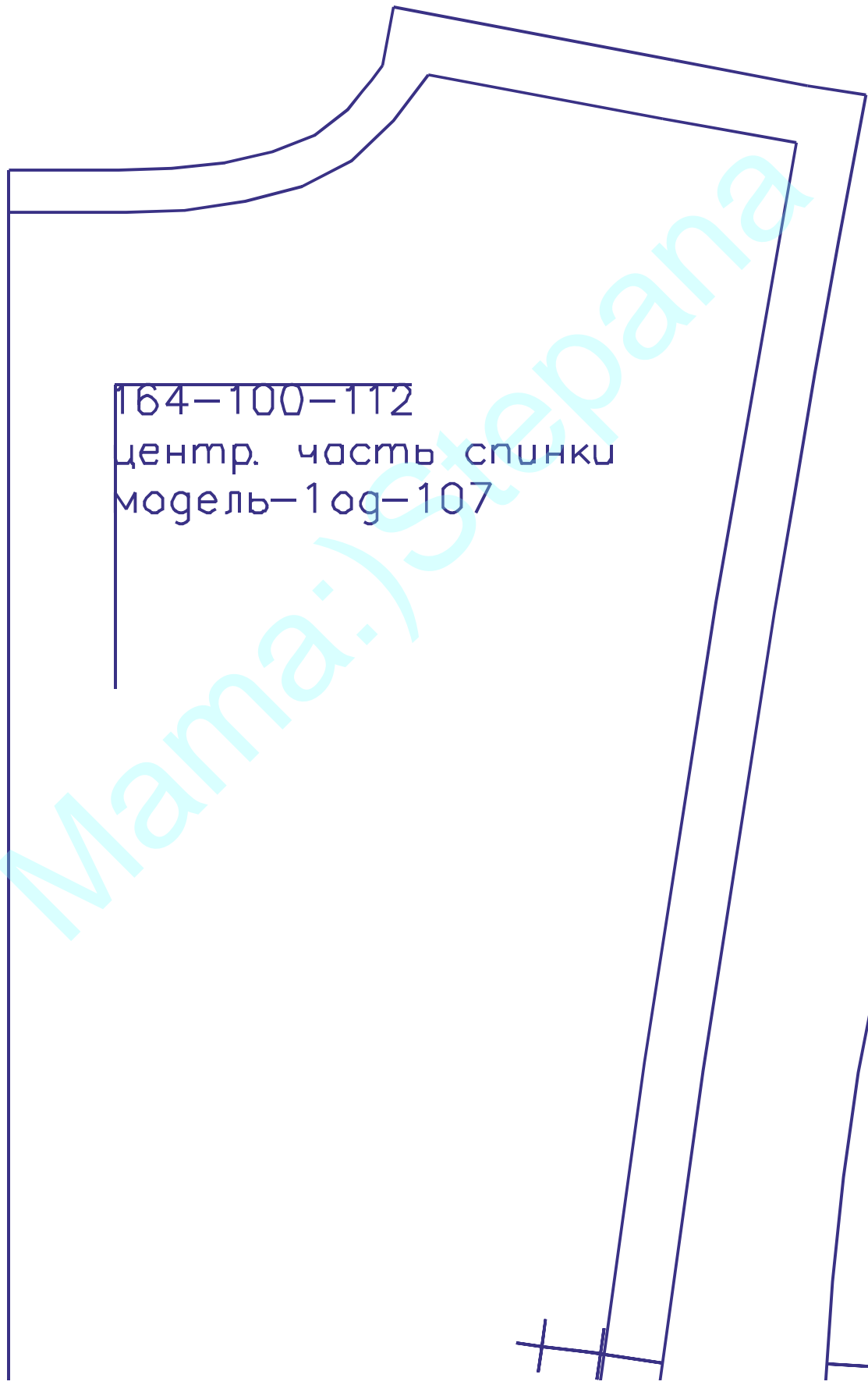

164-100-112
центр. часть спинки
модель-10г-107

Мама: @serana



Mama: :) Stepana



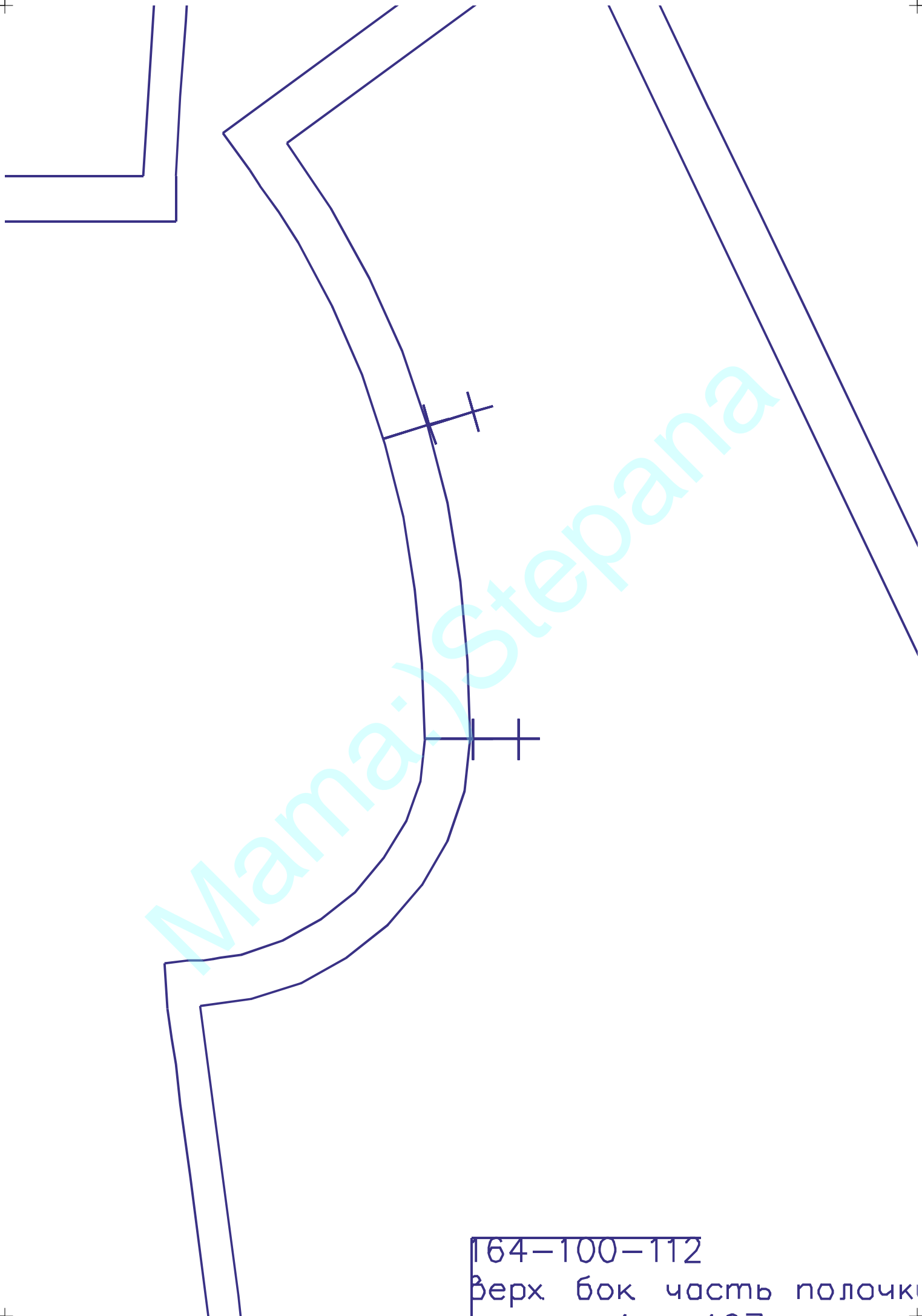

164-100-112

Верх бок часть полочки

Mama :) Stepania

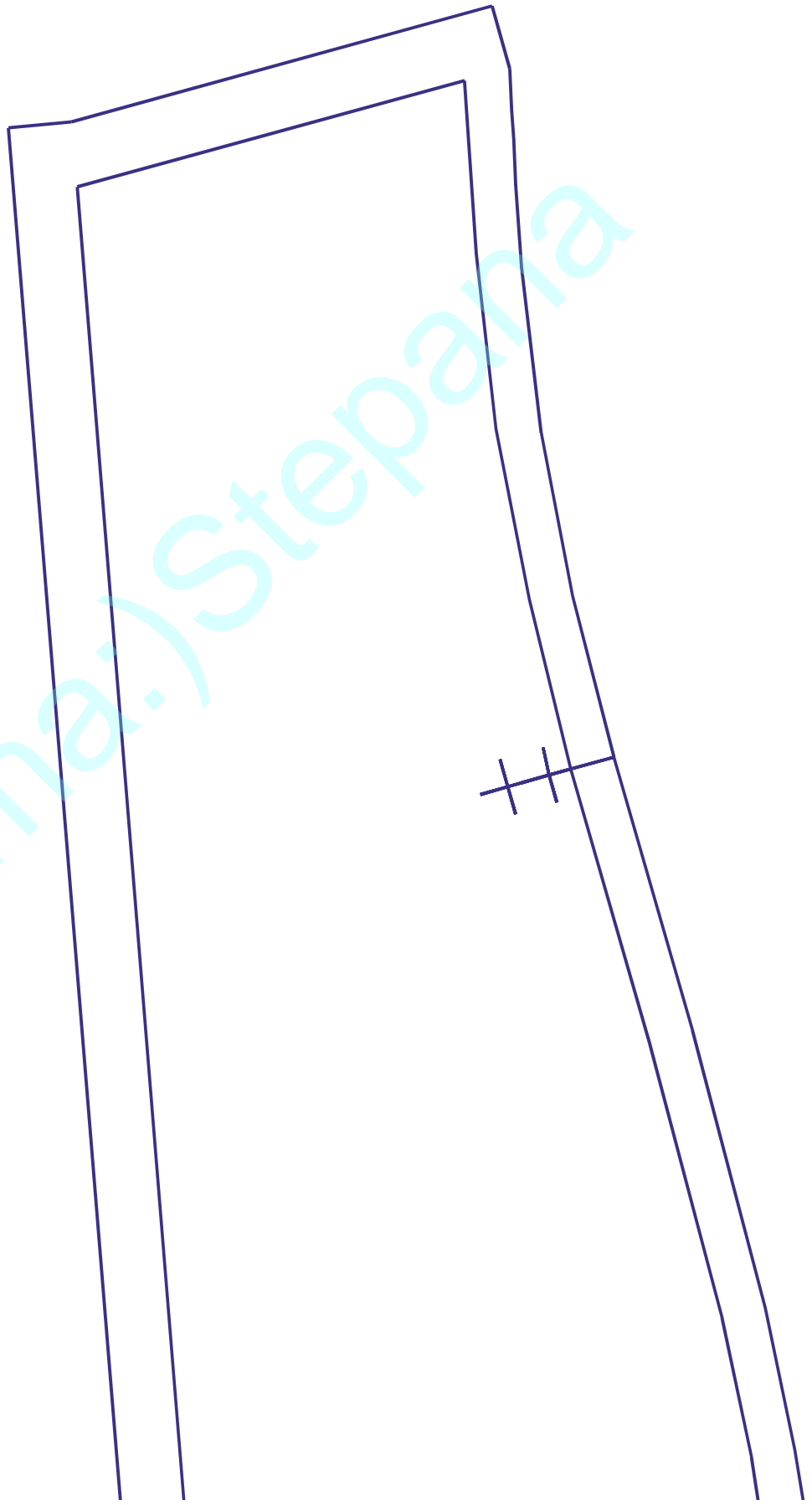
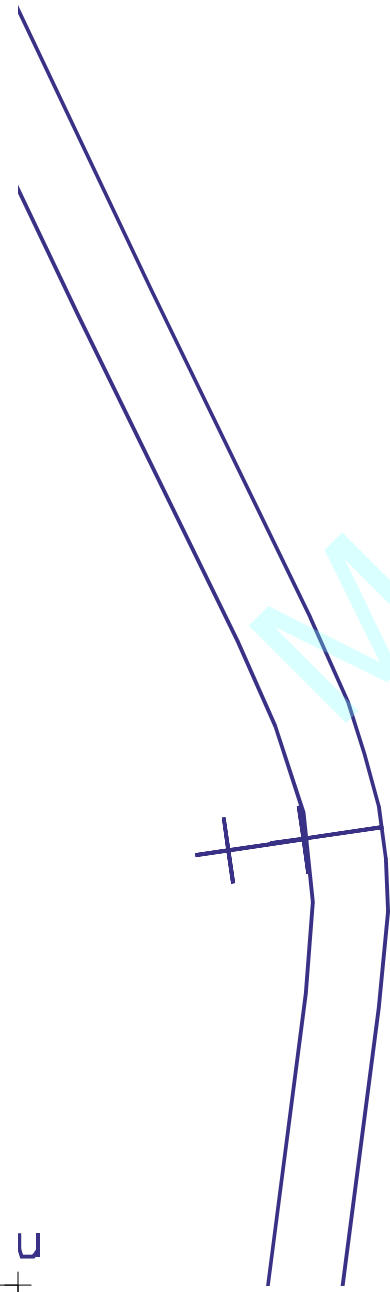

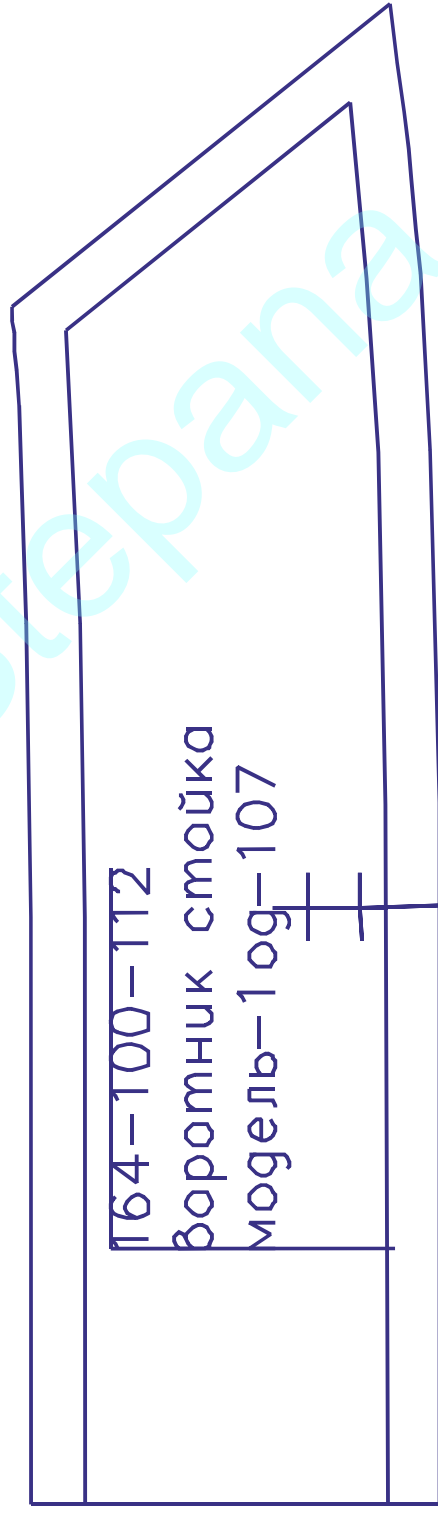
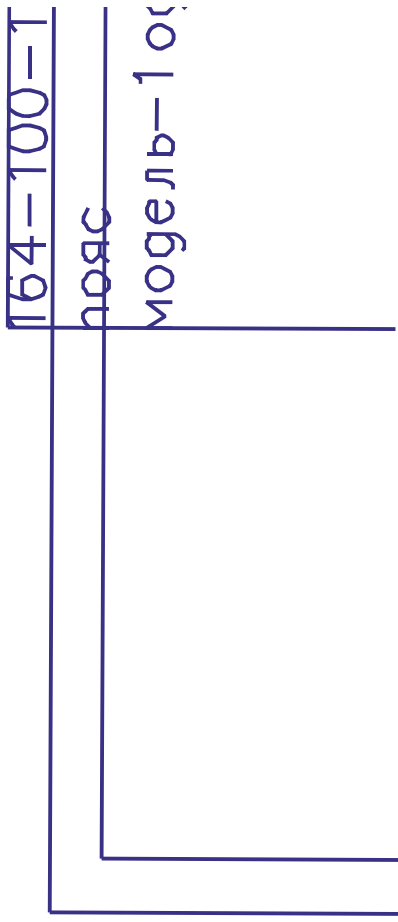

Мама: :) Степан

Mama: :) Stepana

164-100-112
бок. часть спинки
модель-10г-107

Mama:)Stepana

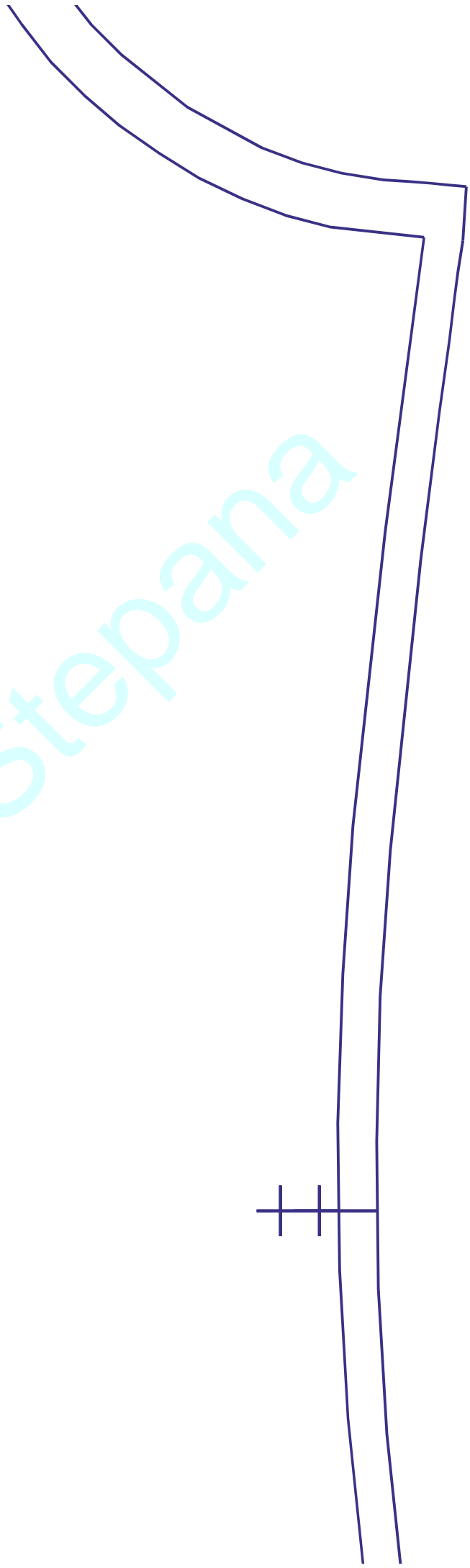

Мама: :) Stepana

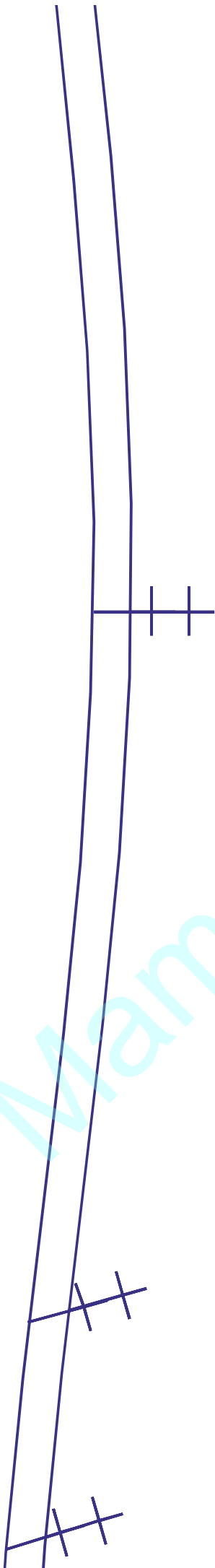

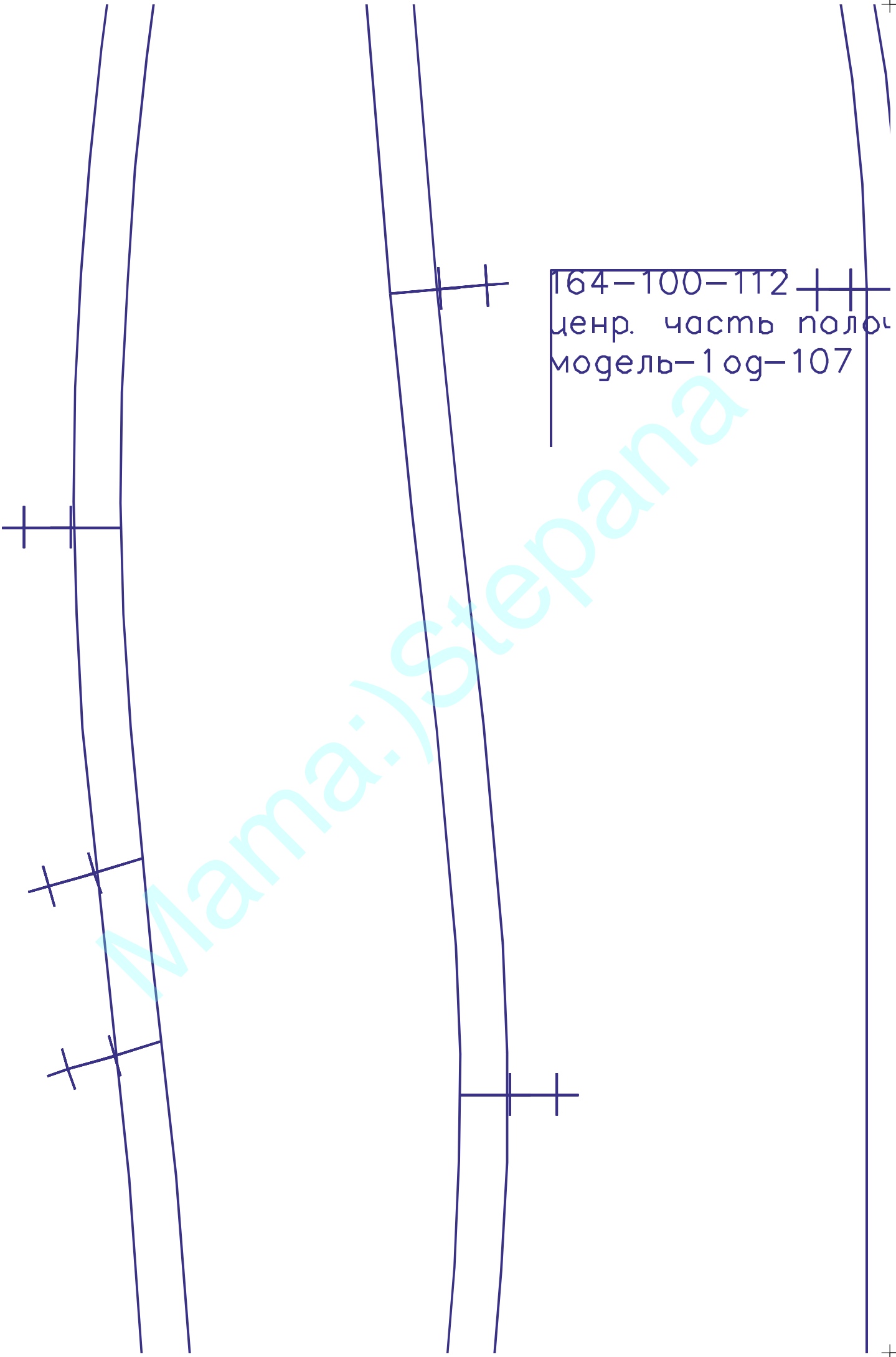

164-100-112
ценр. часть поло
модель-10г-107

Mama :) Stepana

1ку

164-100-112
планка
модель-1ог-107

164-100-112
листочка
модель-1ог-107

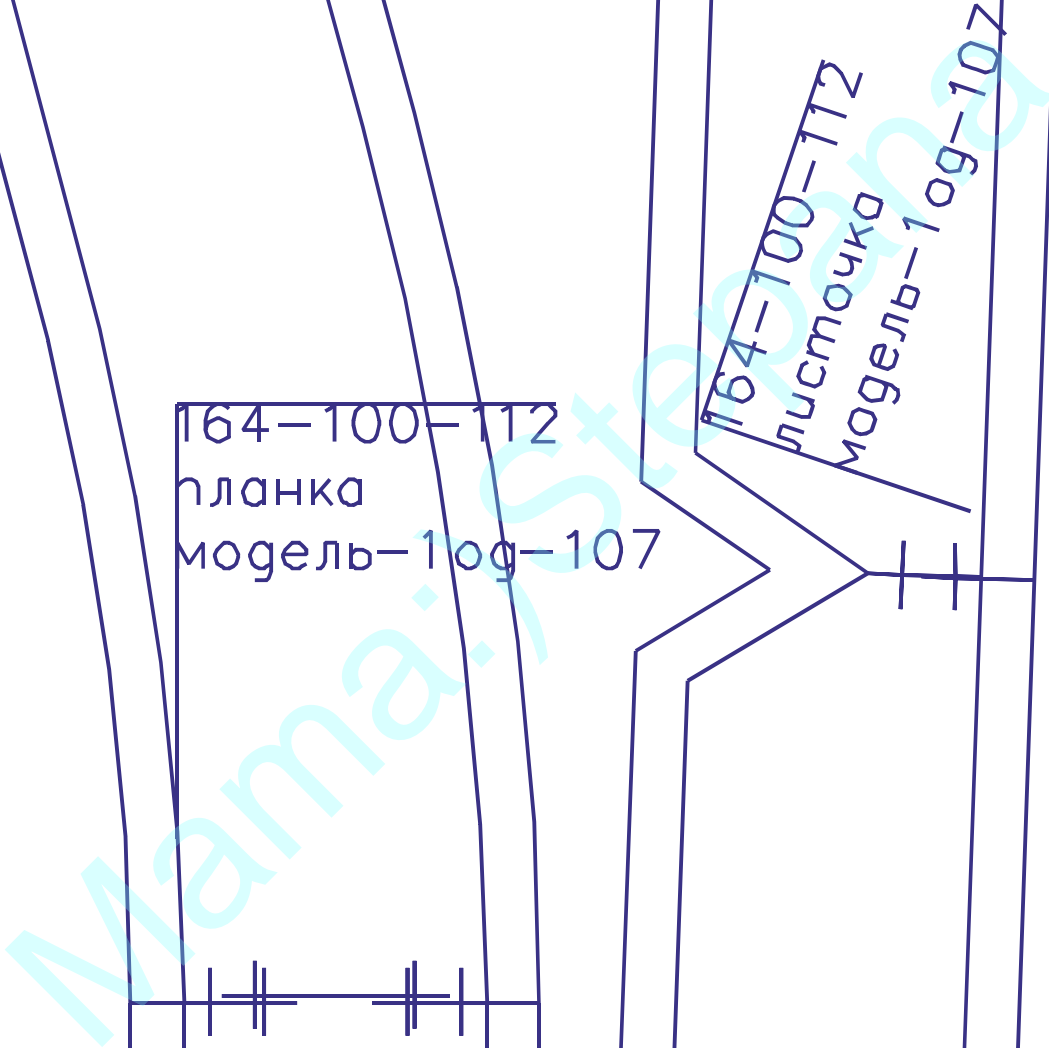

Mama: :) Stepana

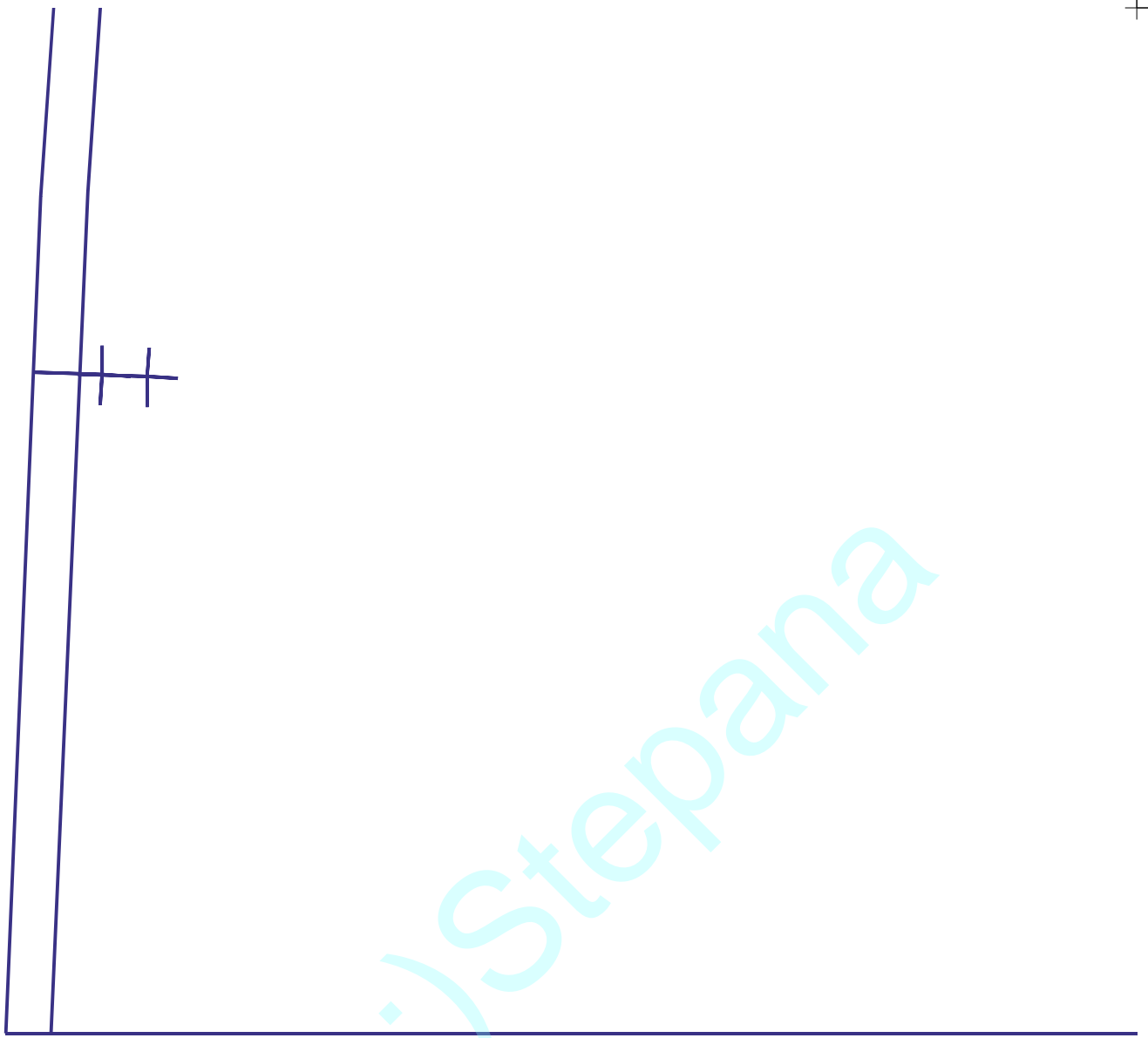

Мама: :) Stepana

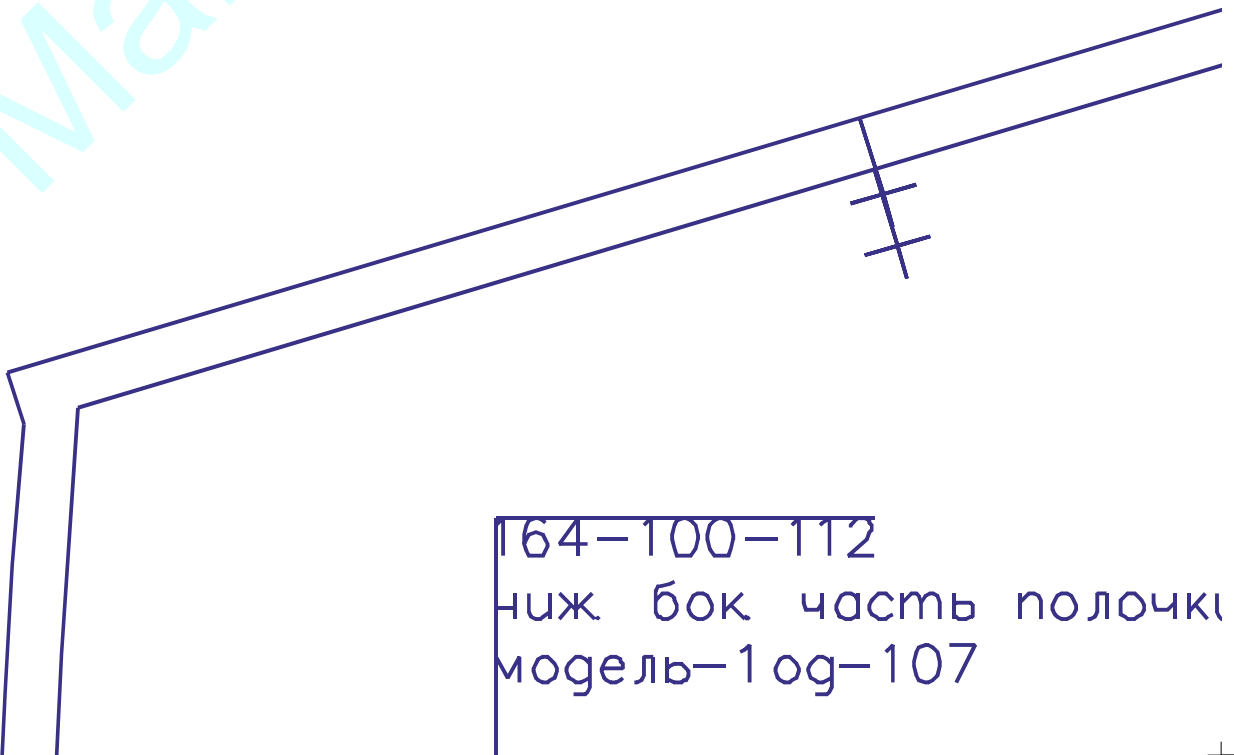

164-100-112

ниж. бок. часть полочки
модель-10г-107

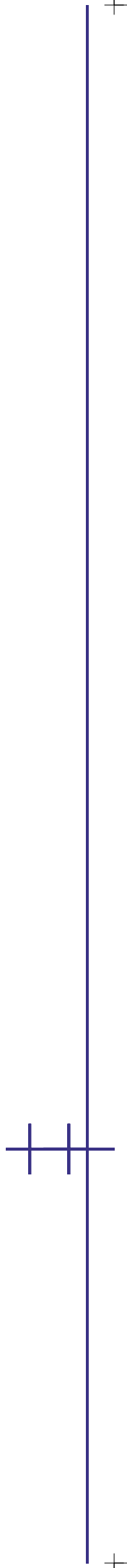
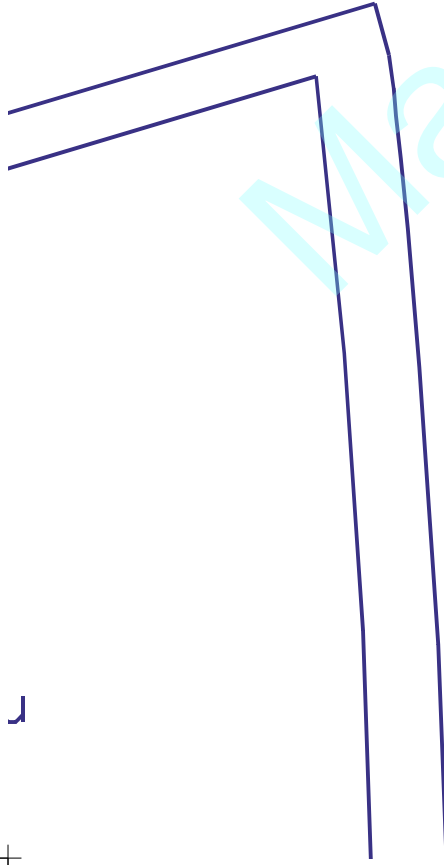
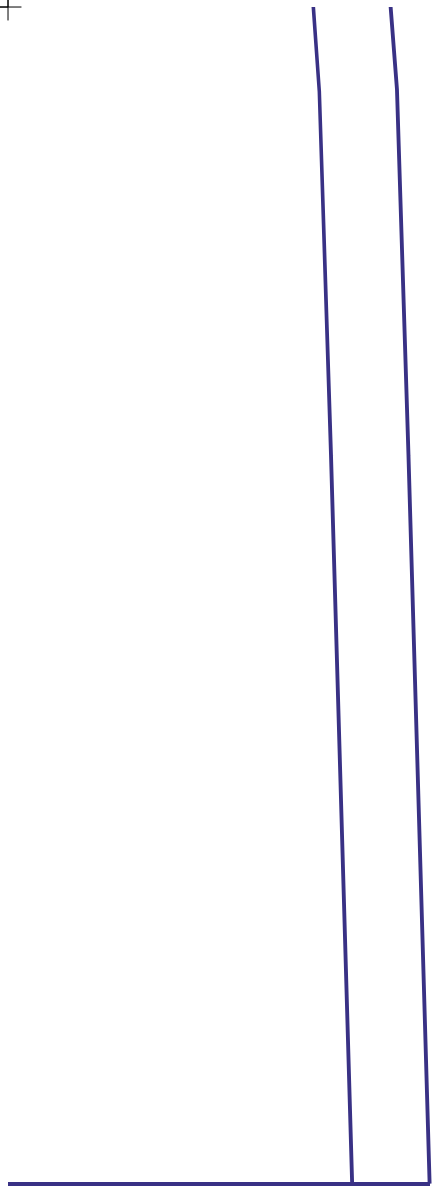

Mama :) Stepana



Mama: Stepana

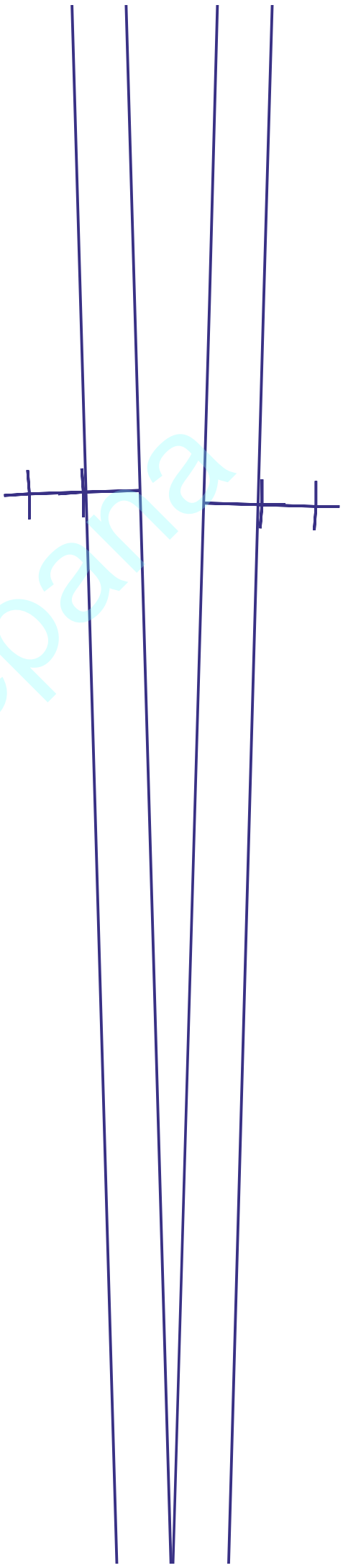

Mama:.)Stepana

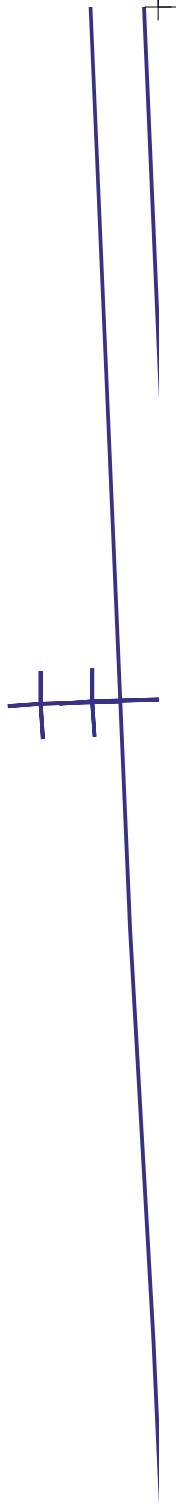
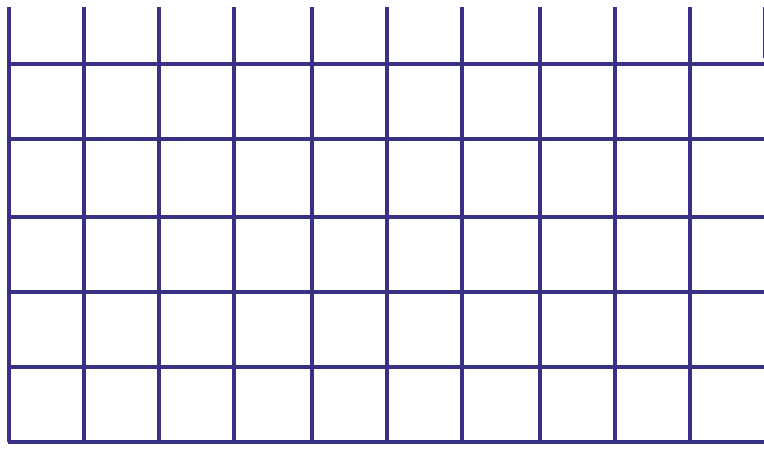

Mama: :) Stepana

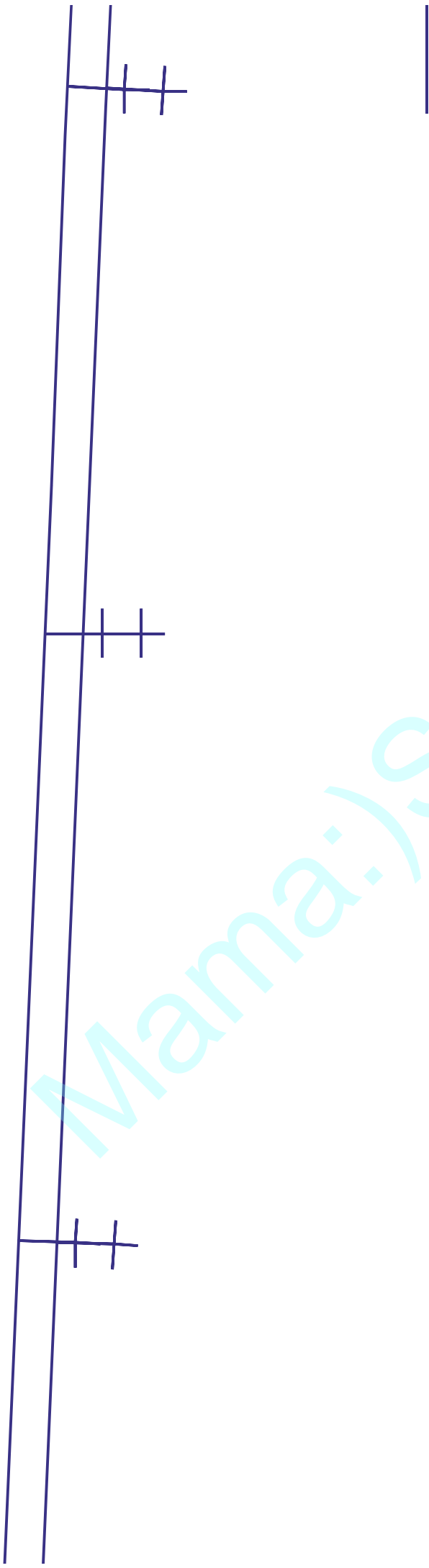

Mama: :) Stepana

Mama :) Stepana

Blank handwriting practice lines with a central line and two side lines. A vertical line is drawn on the left side, and a vertical line is drawn on the right side. There are two sets of vertical tick marks on the central line, one on the left and one on the right.

Blank handwriting practice lines with a central line and two side lines. A vertical line is drawn on the left side, and a vertical line is drawn on the right side. There are two sets of vertical tick marks on the central line, one on the left and one on the right.

164 100 112
манжета
модель-1 ог-1

Мамма: Степана

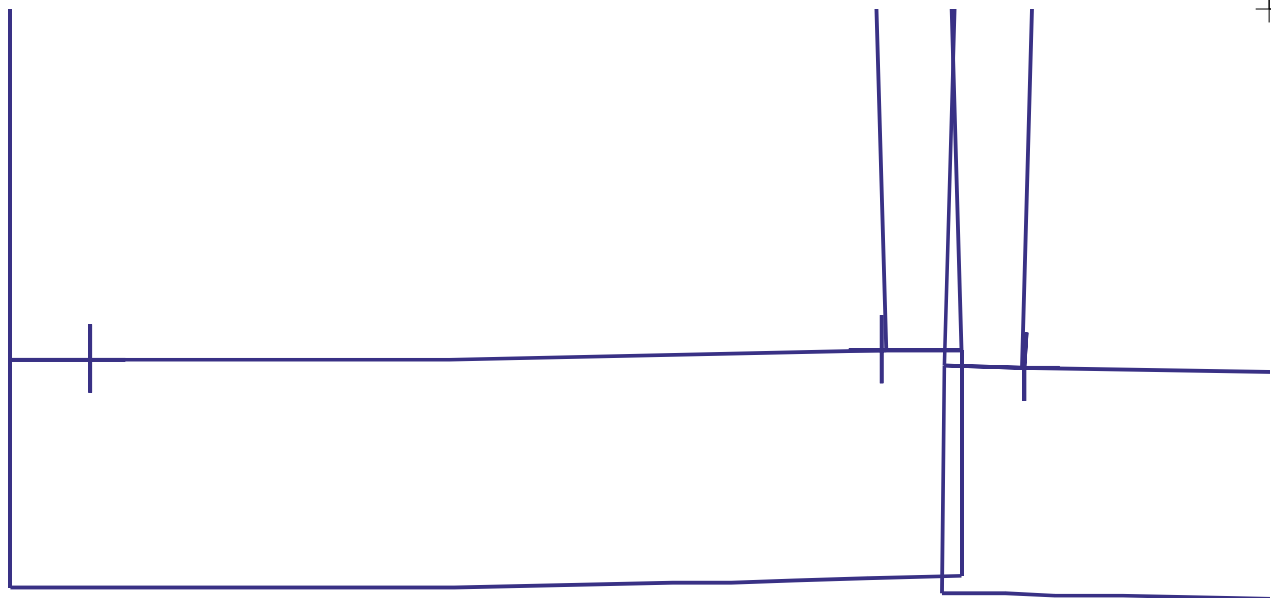

Mama:;)Stepana

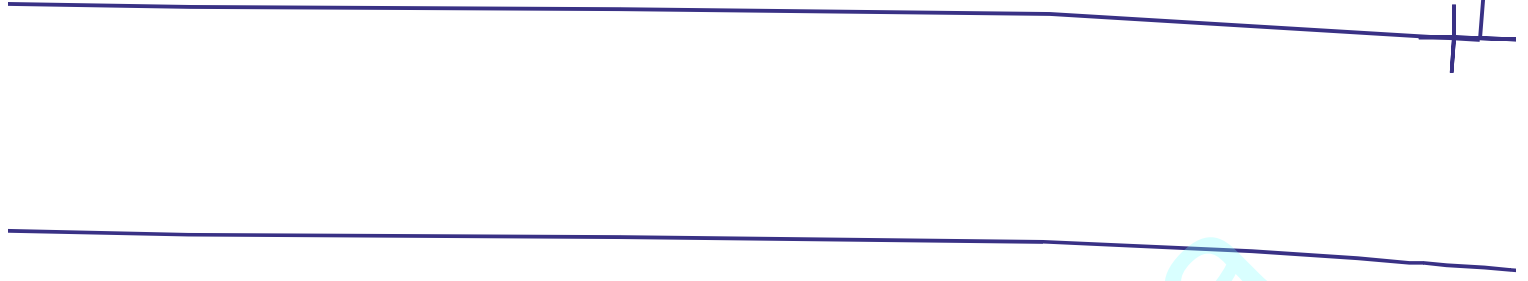

Mama:.)Stepana

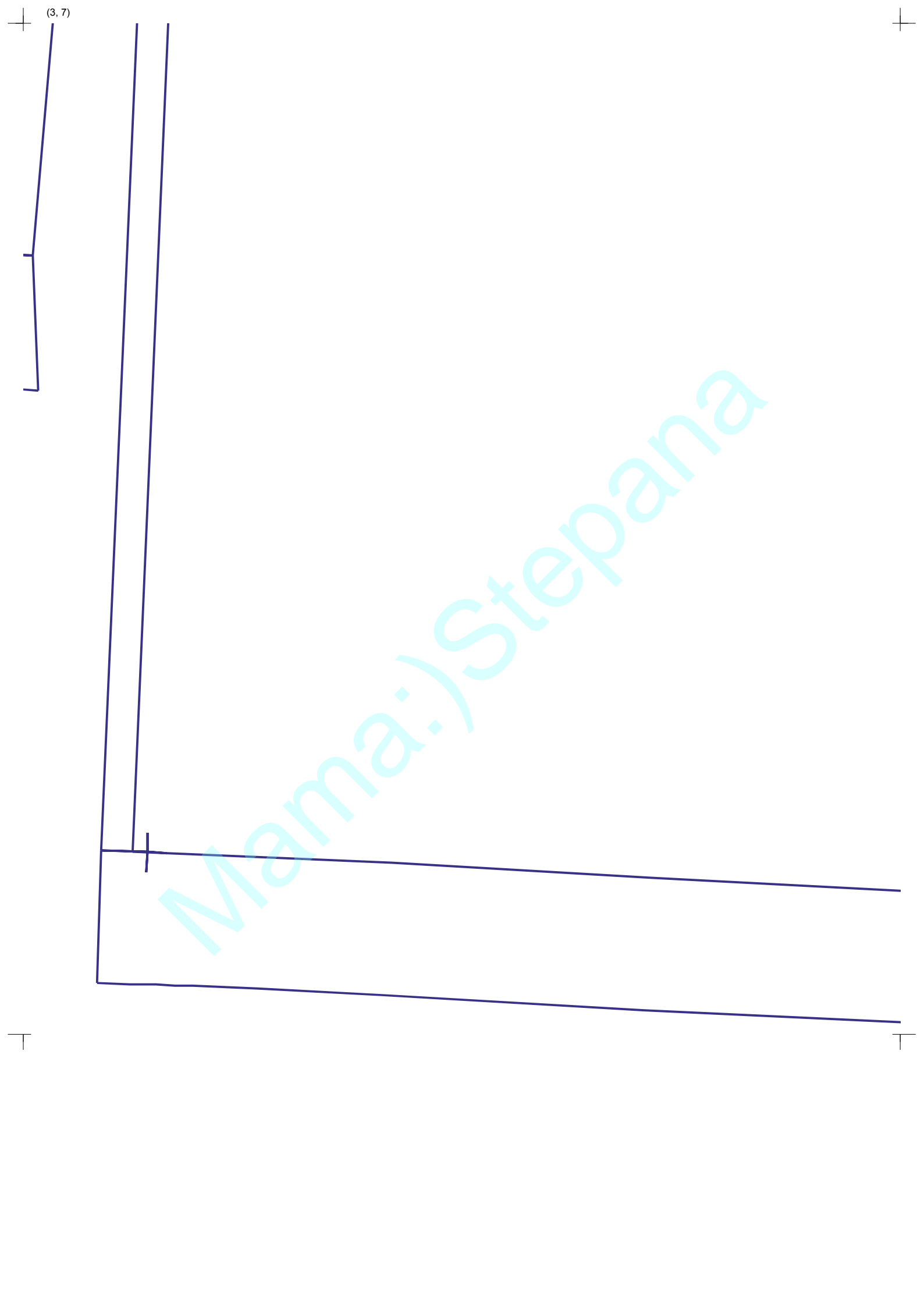

(3, 7)

Mama:.)Stepana

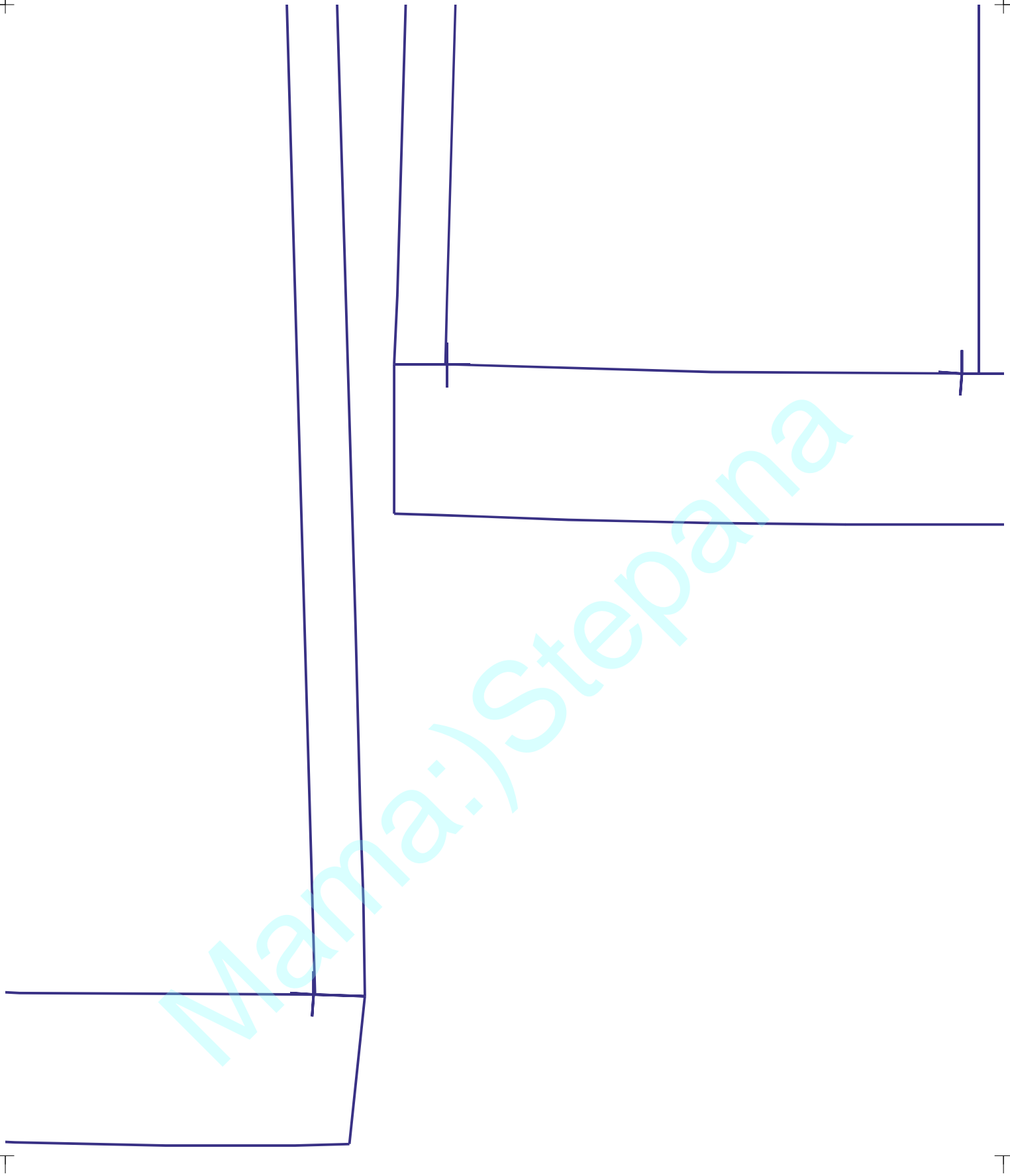

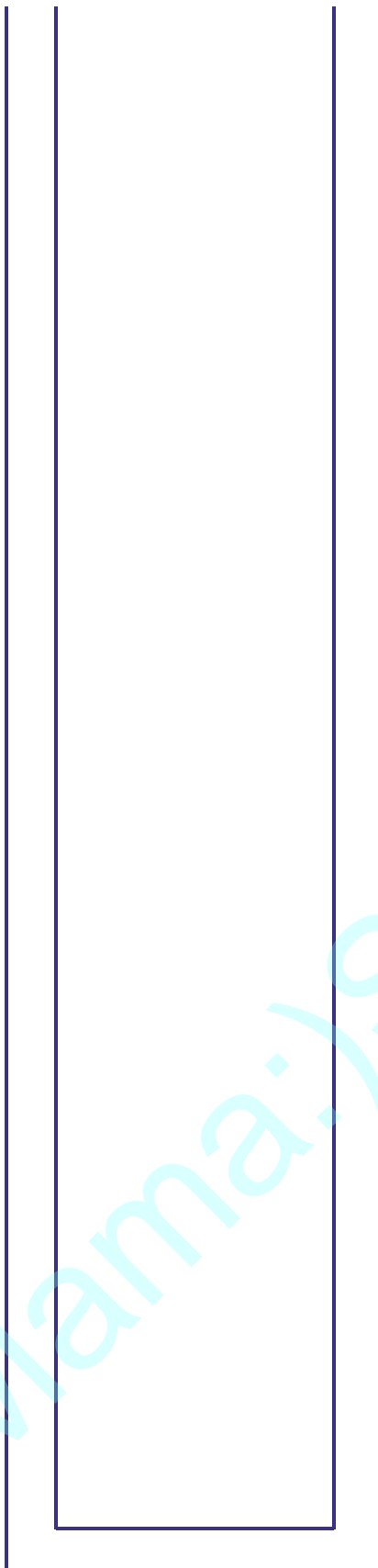

Mama: :) Stepana

