

(A, 01) : 8-10.mdl (. . \YSR\PDF\)

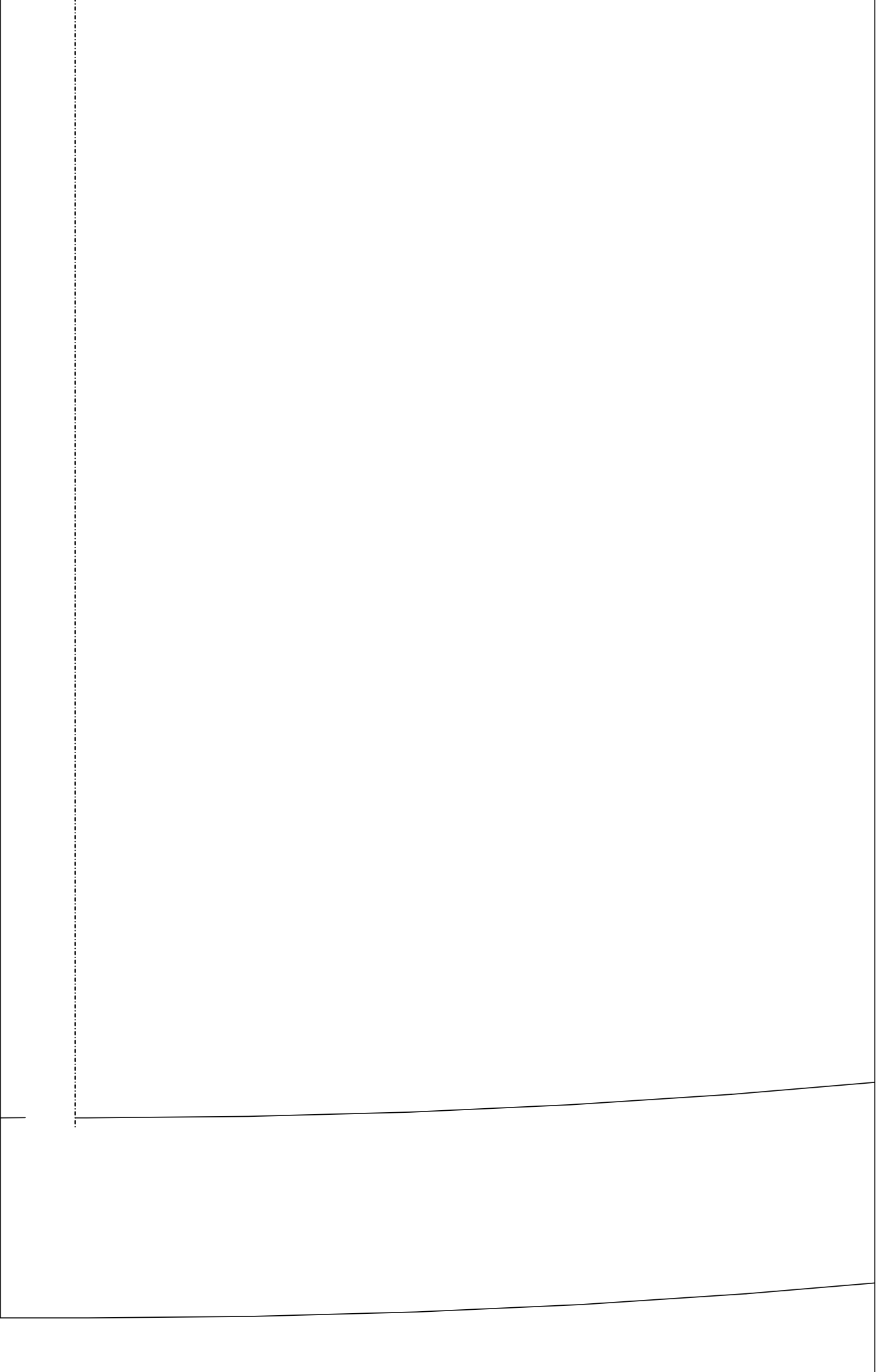

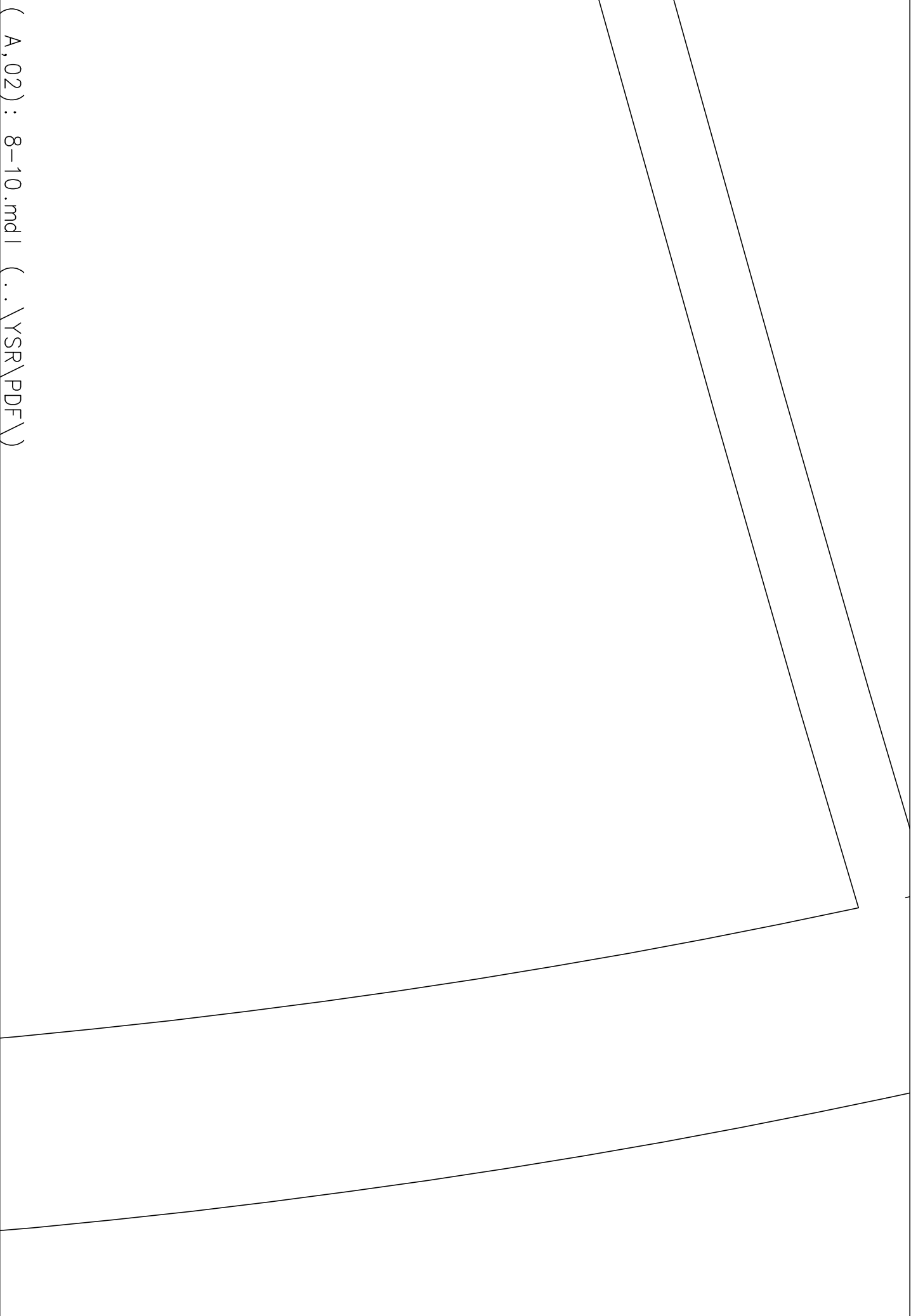

(A, 02) : 8-10.mdl (.. \YSR\PDF\)

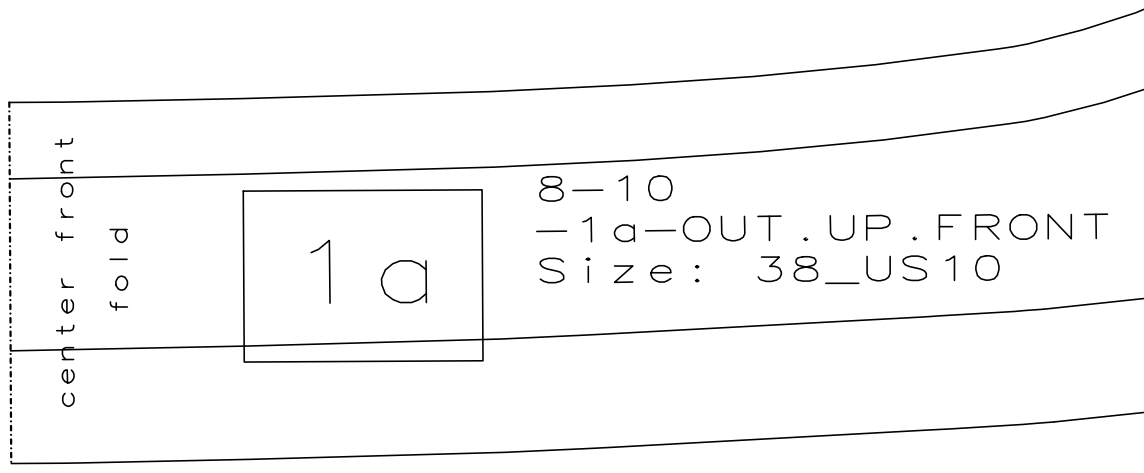

FABRIC: CUT 1x ON FOLD

FACING

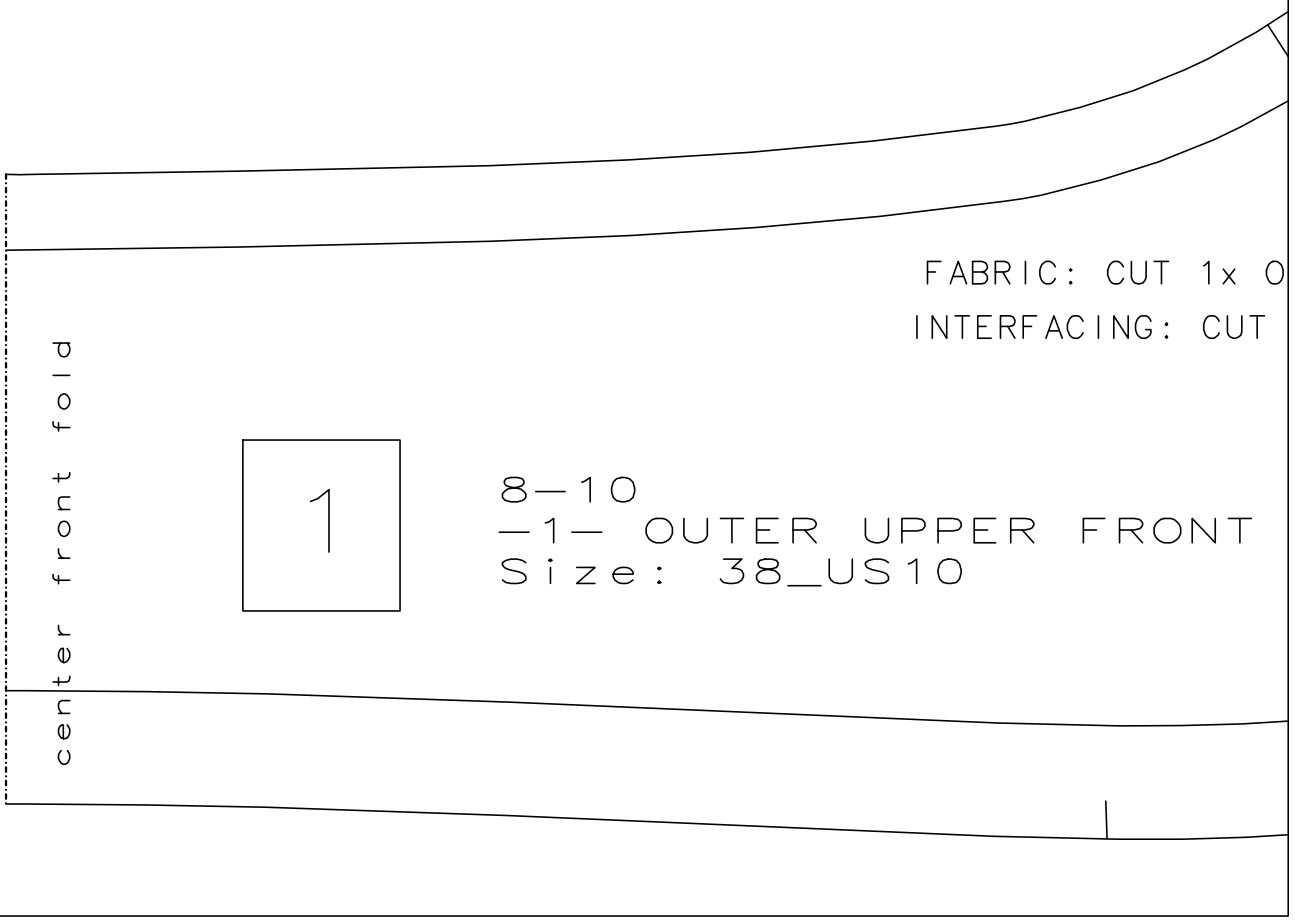
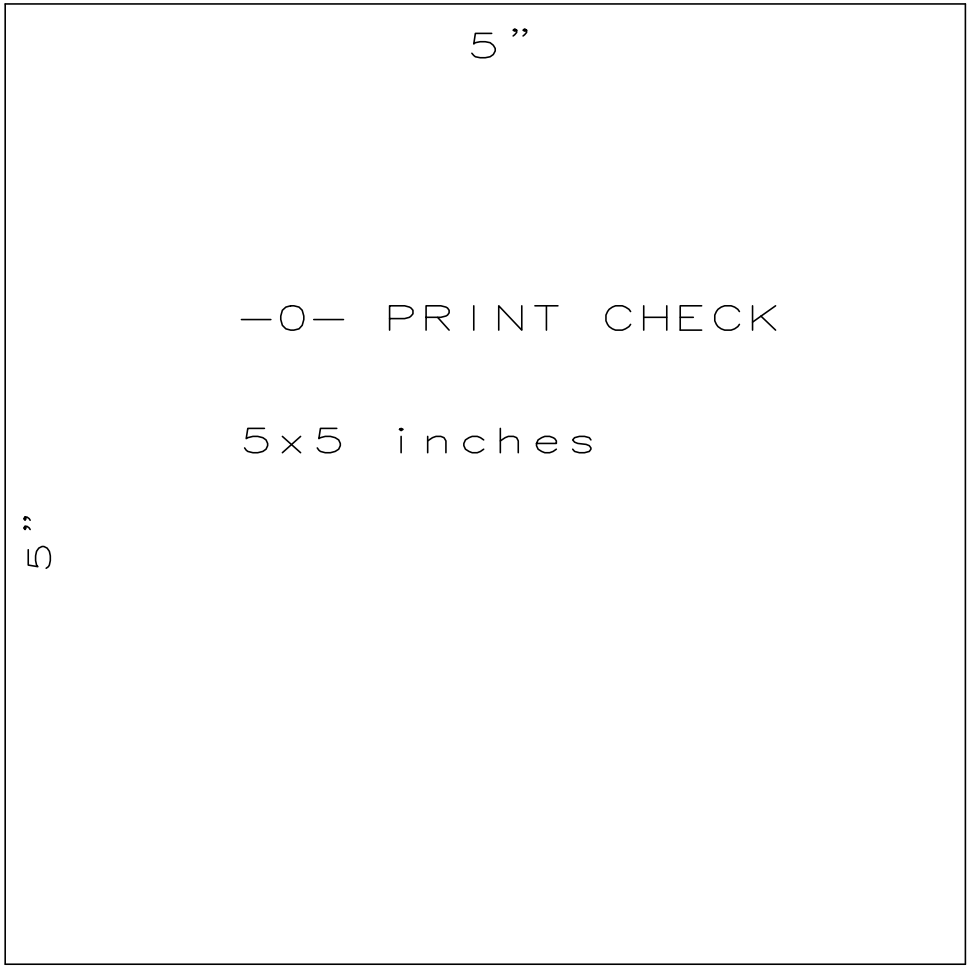

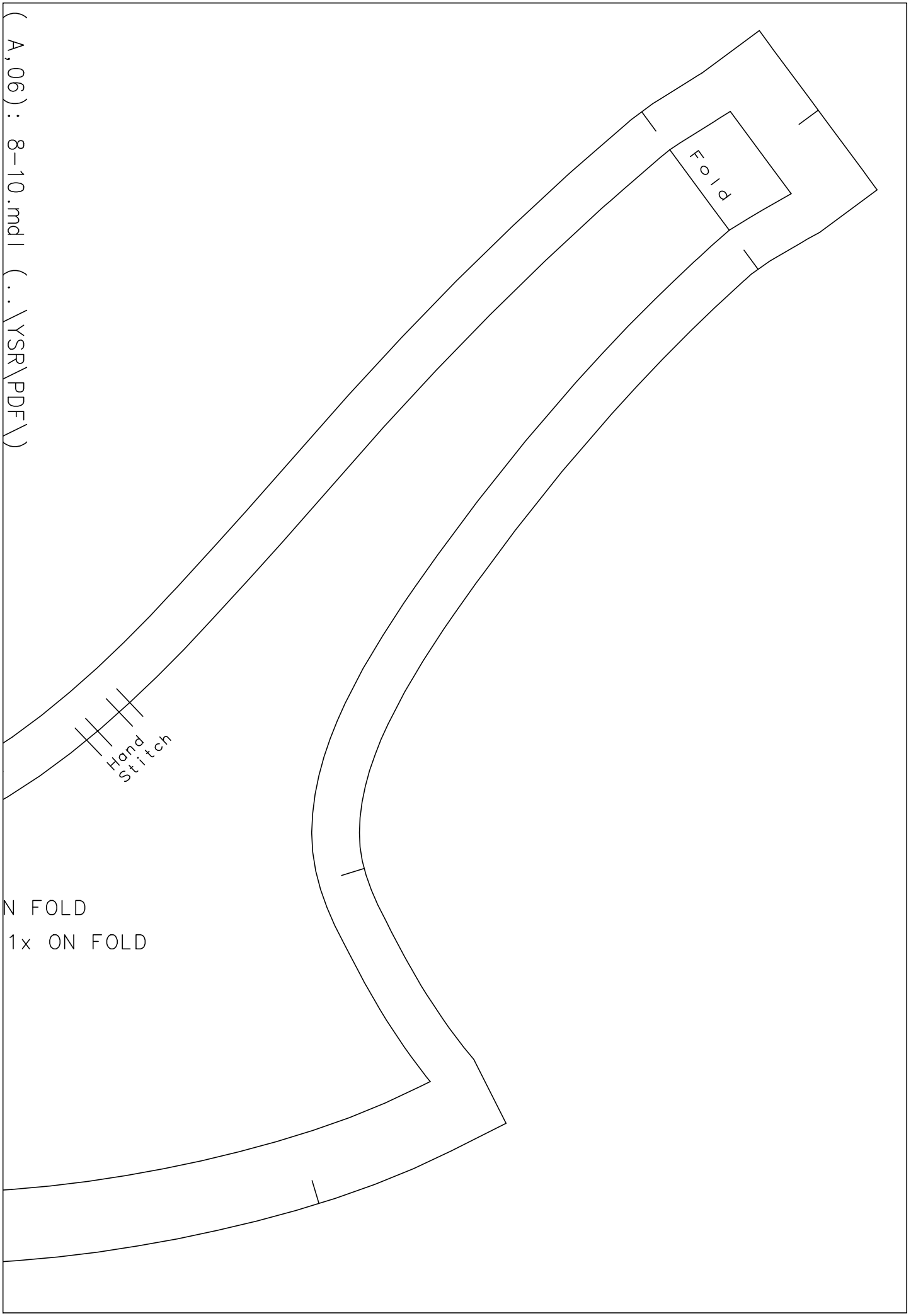

Fold

Hand
Stitch

N FOLD
1x ON FOLD

(A, 06) : 8-10.mdl (.. \YSR\PDF \)

UPPER FRONT FACING
: 38_US10

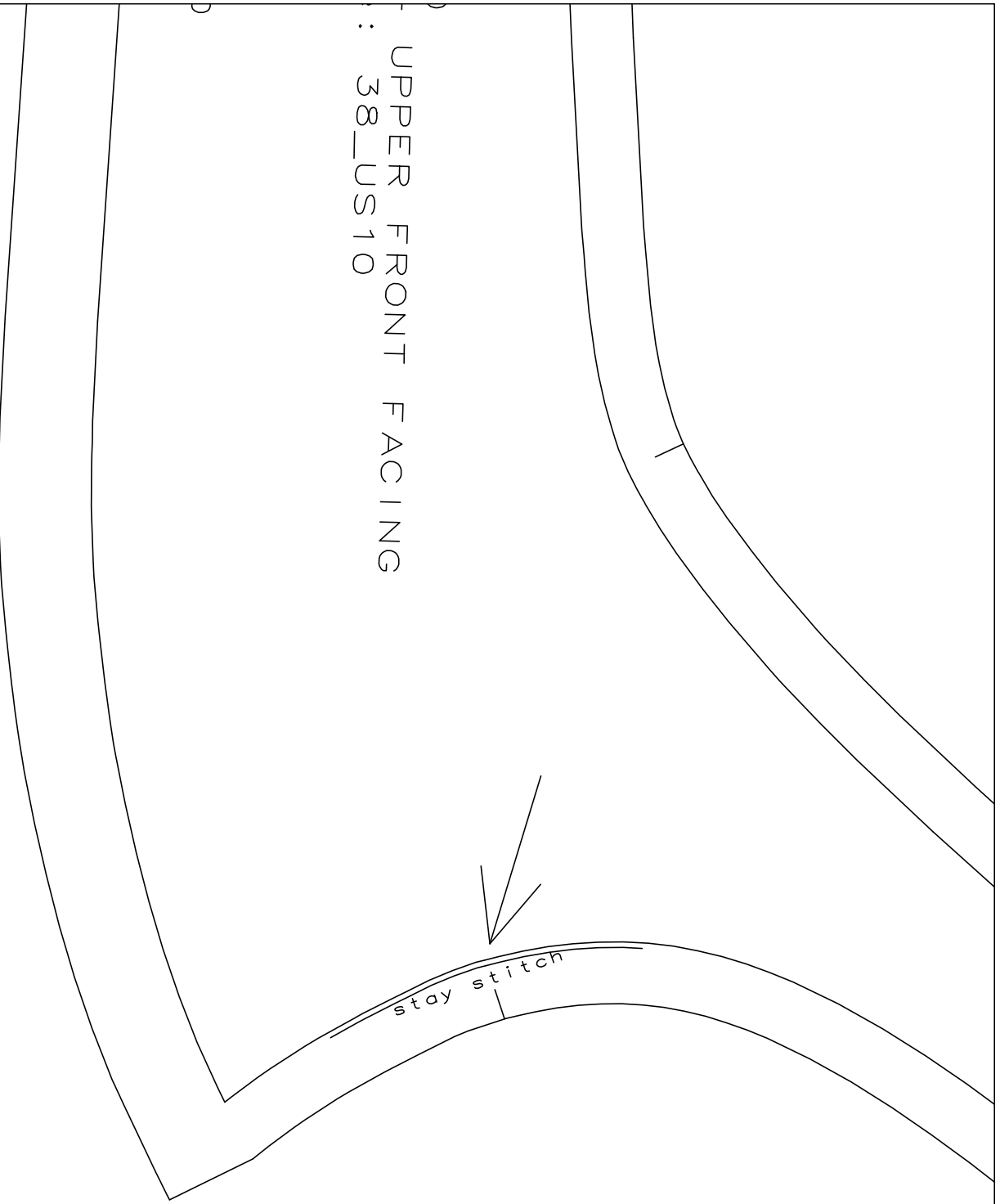

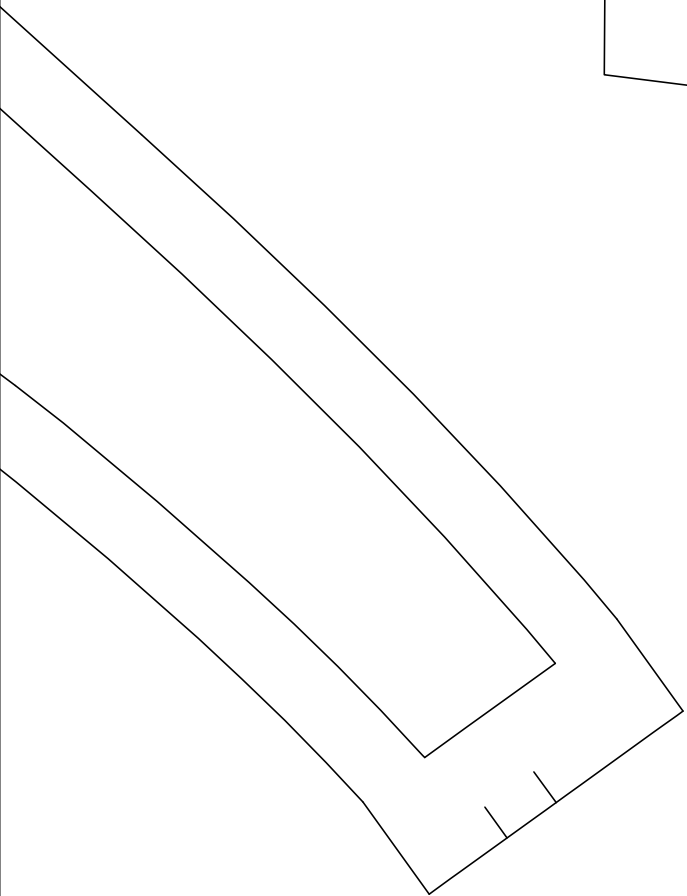
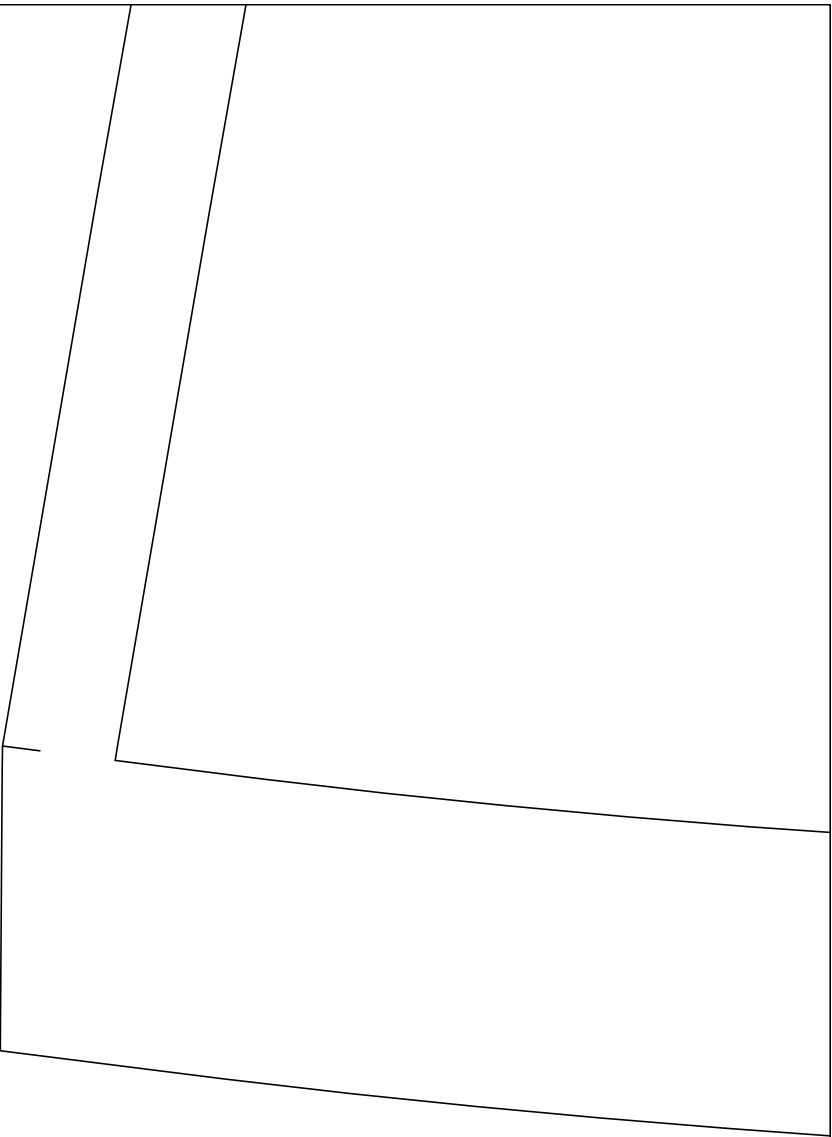

(A, 08) : 8-10.mdl (.. \YSR\PDF\)

(A, 09) : 8-10.mdi (.. \YSR\PDF\)

(A, 10) : 8-10.mdl (.. \YSR\PDF\)



8-10
-3- FRONT
Size : 38_US10

grainline

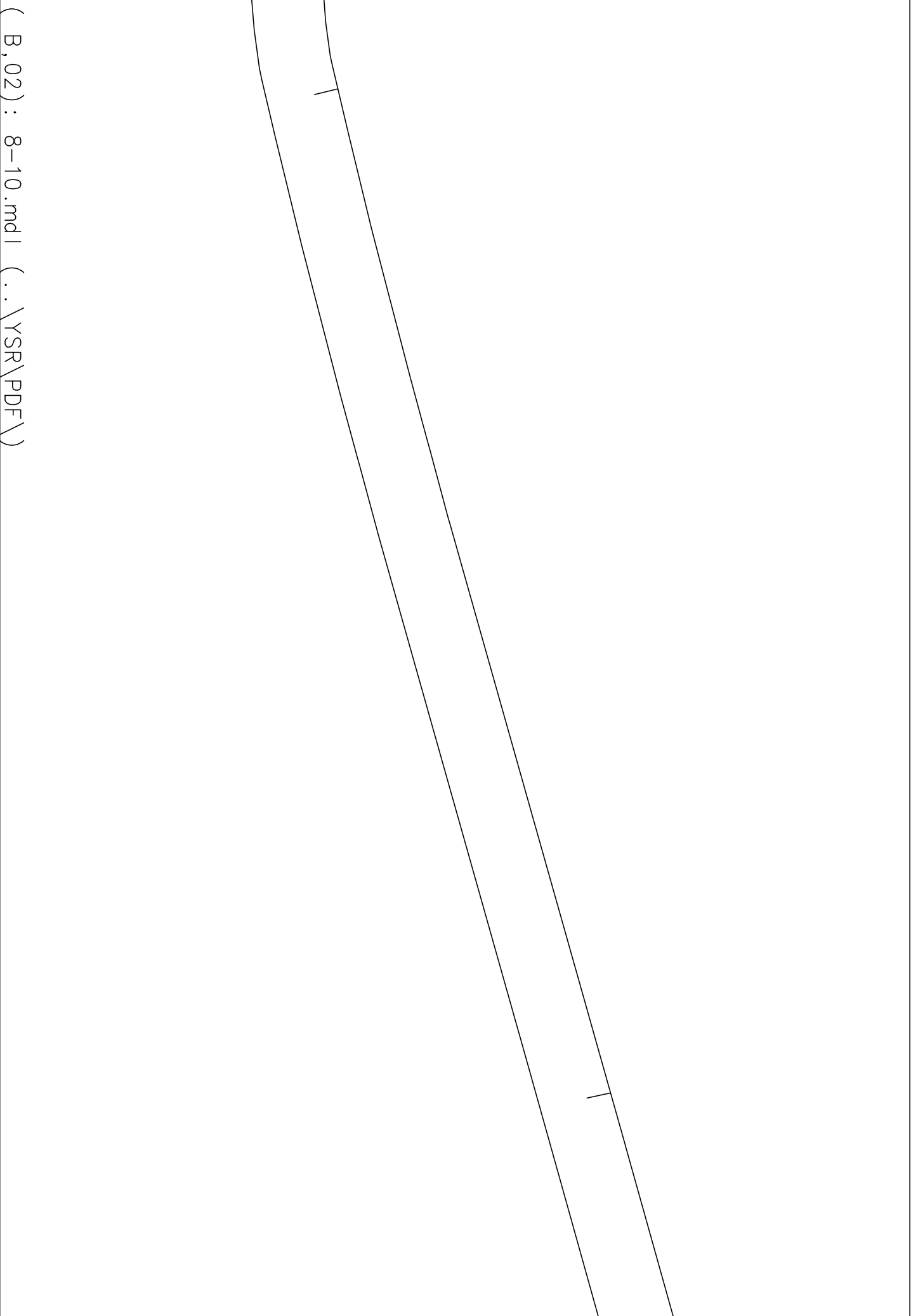

(B, 02) : 8-10.mdl (.. \YSR\PDF\)

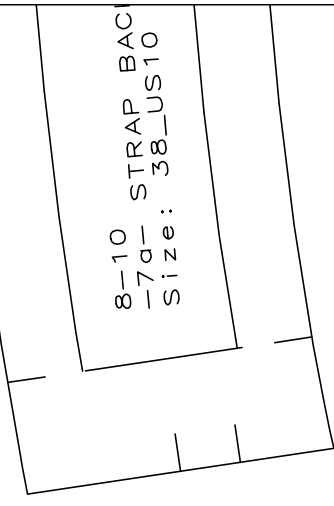
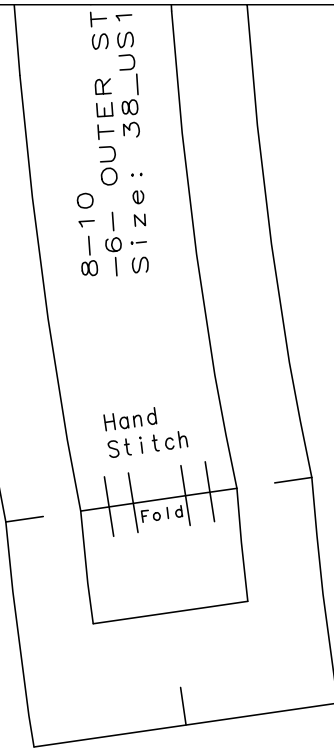
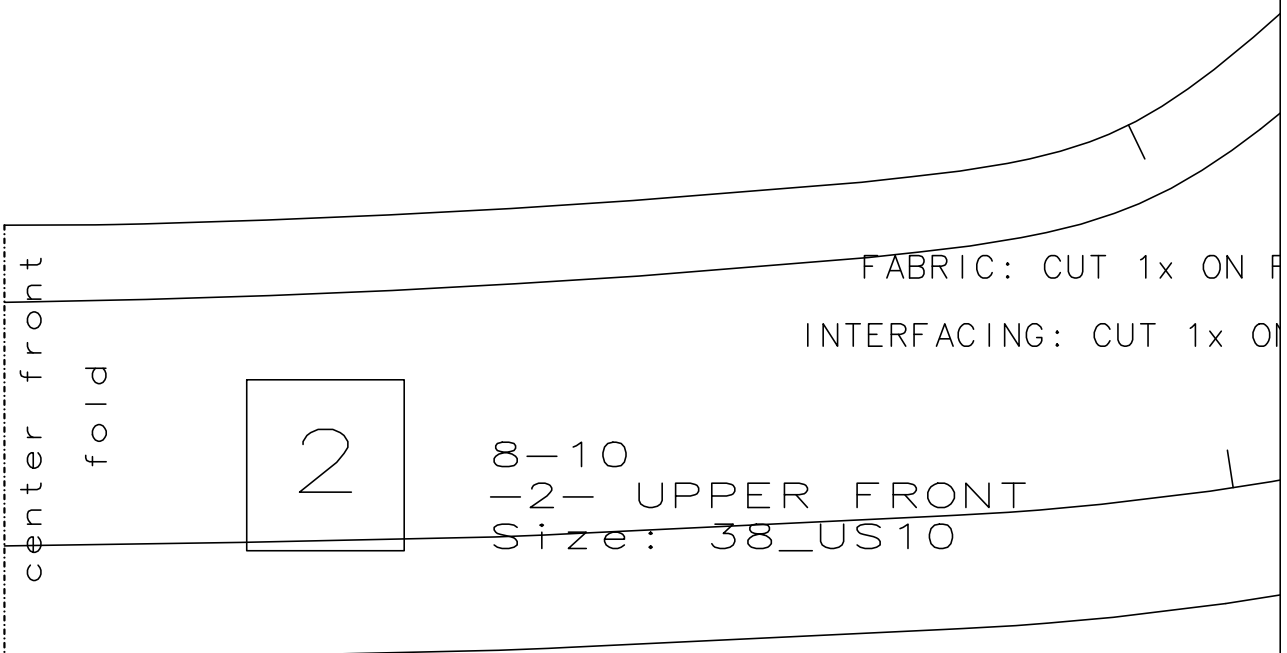

(B, 04) : 8-10.mdl (.. \YSR\PDF\)



OLD
N FOLD

C: CUT 2x

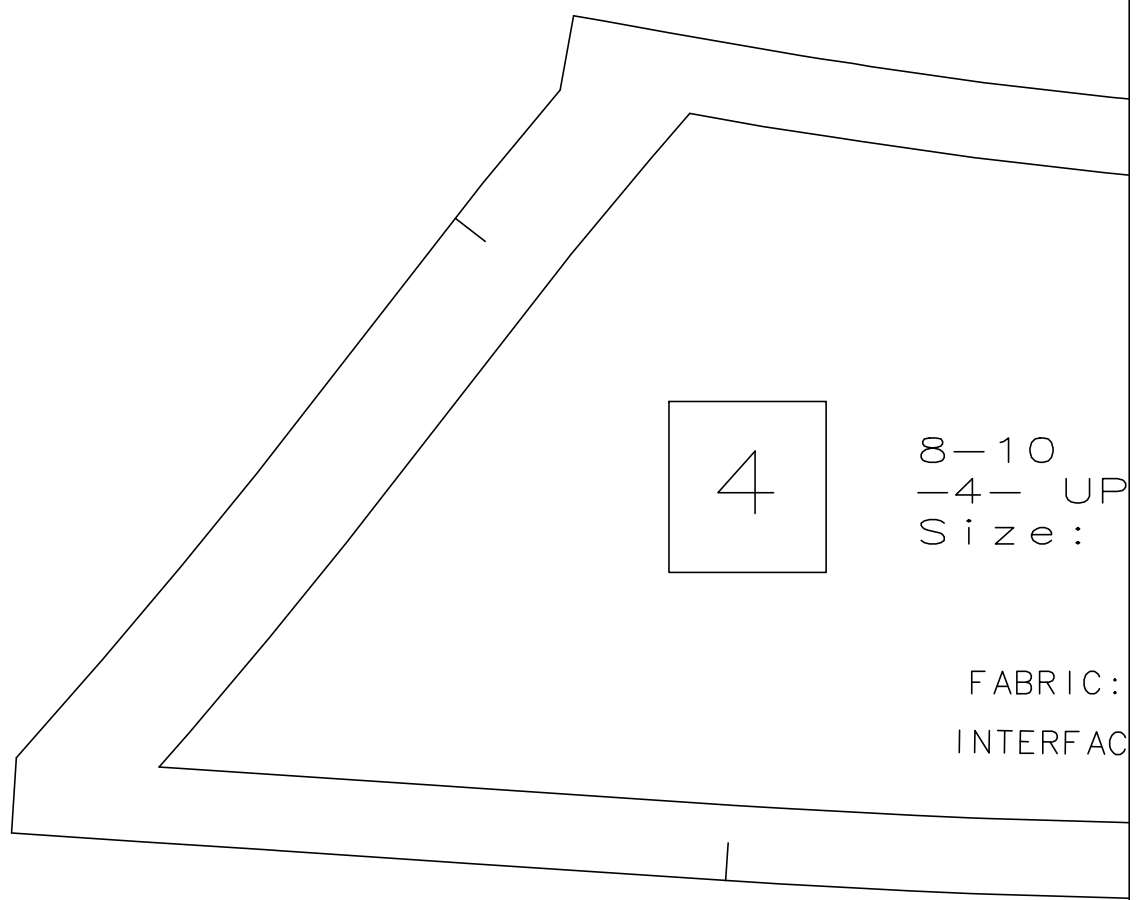
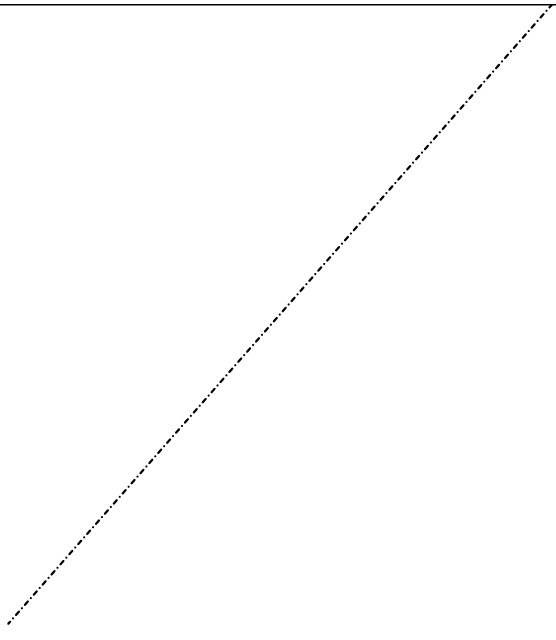

4

8-10
-4- UP
Size:

FABRIC:
INTERFAC

BRA
O
(B,06) : 8-10.mdl (..\YSR\PDF\)

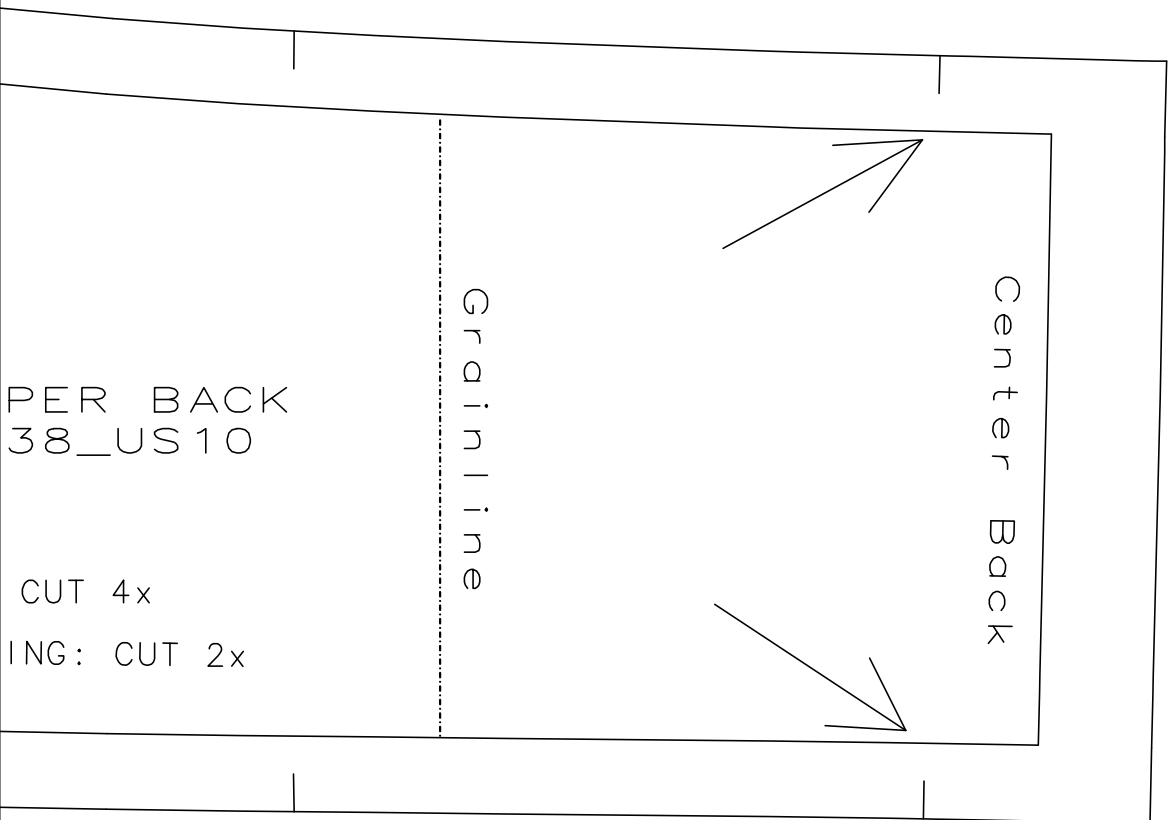

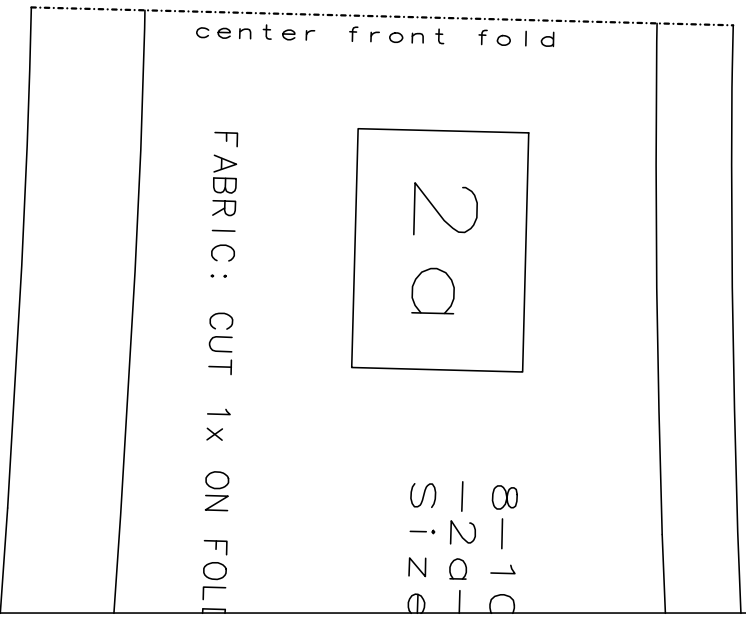
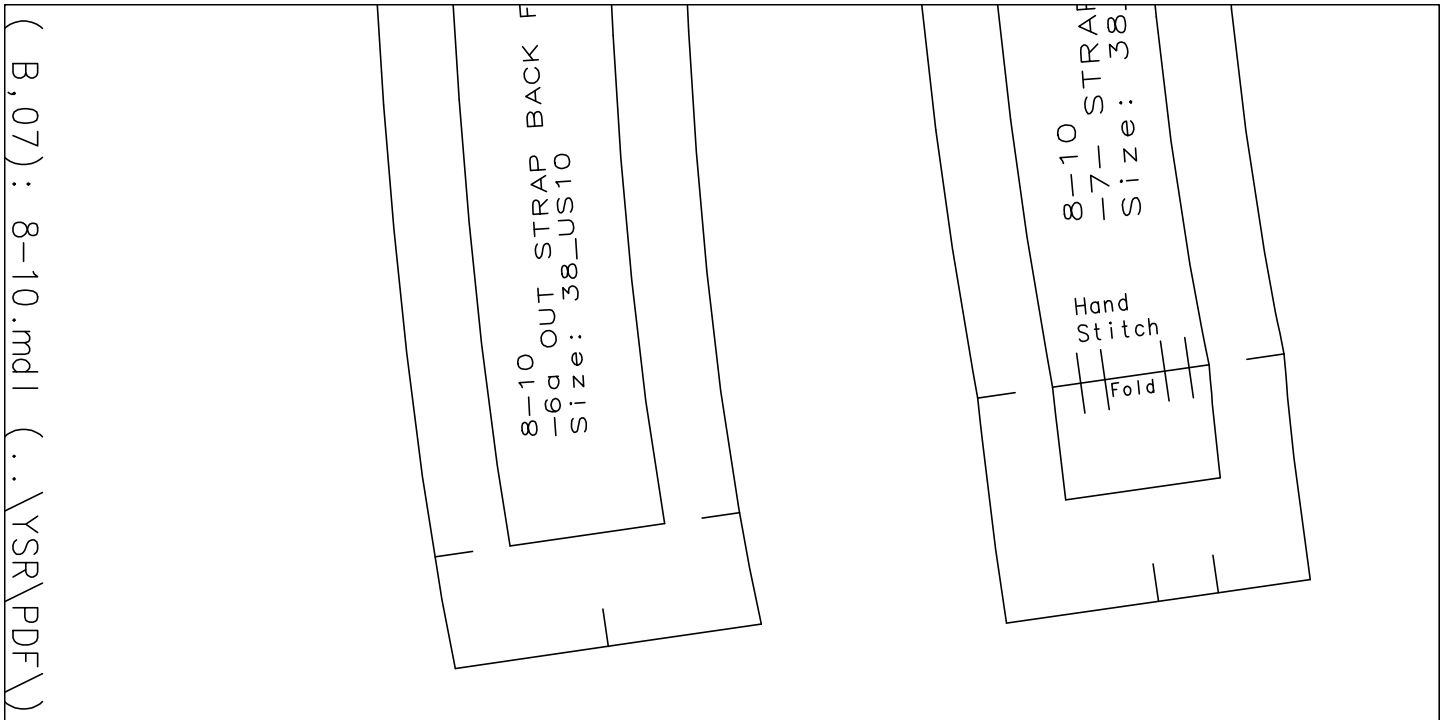

(B,07) : 8-10.mdl (.. \YSR\PDF\)

(B,08) : 8-10.mdl (..\YSR\PDF\)

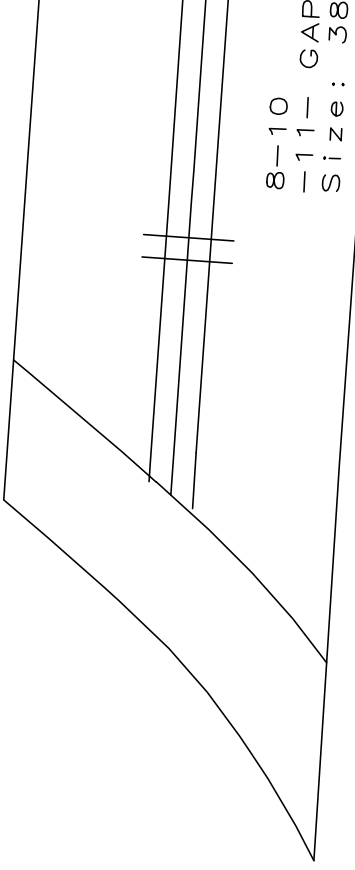

8-10
-11- GAP
Size: 38

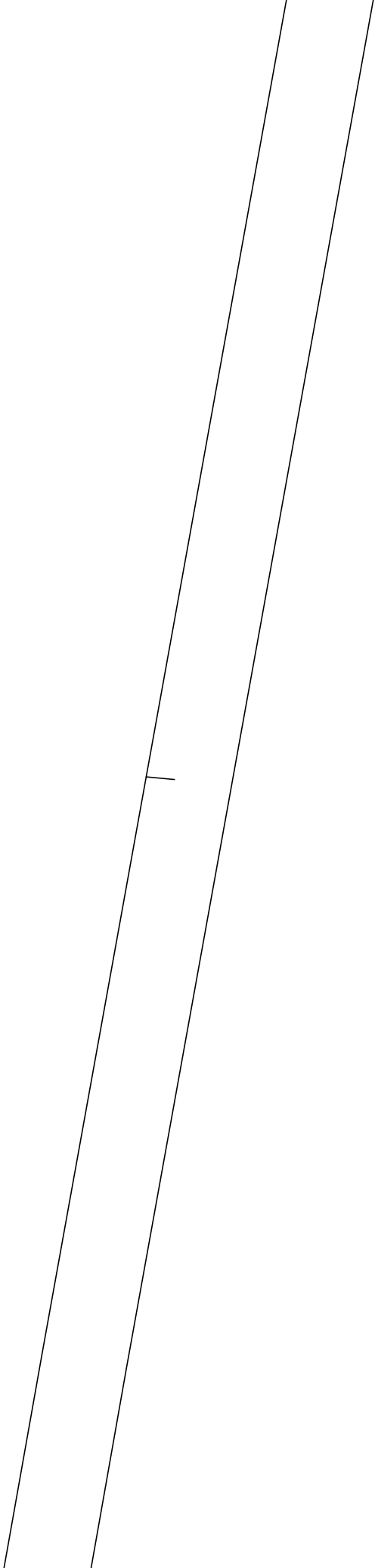

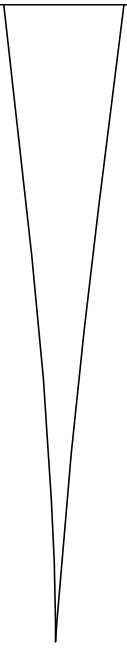

grainline

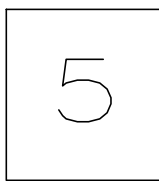

8-10
-5- BACK
Size: 38_US10

FABRIC: CUT 2x

LINING: CUT 2x

zipper

(B, 10) : 8-10.mdl (.. \YSR\PDF\)

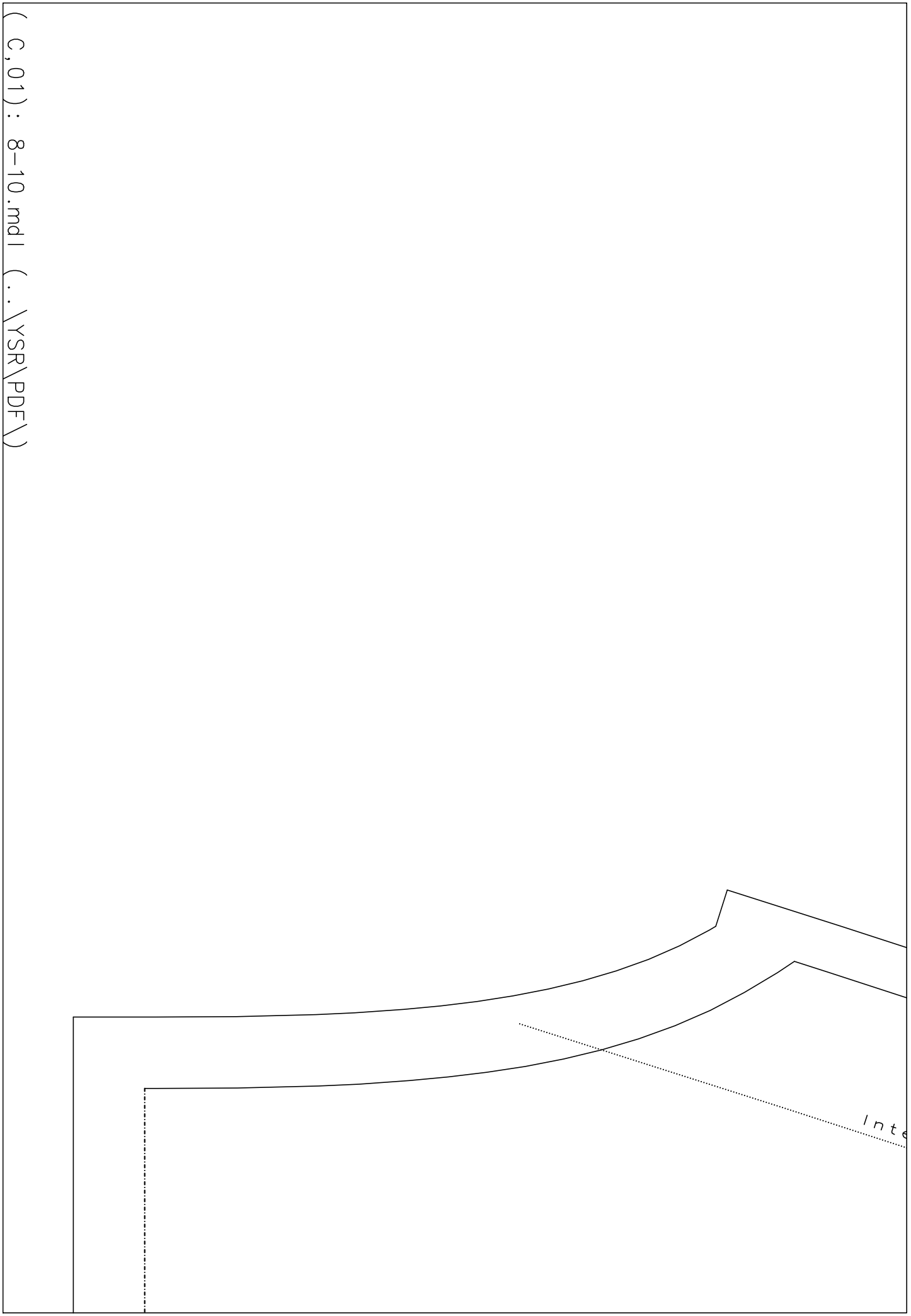

(c, 01) : 8-10.mdl (.. \YSR\PDF \)

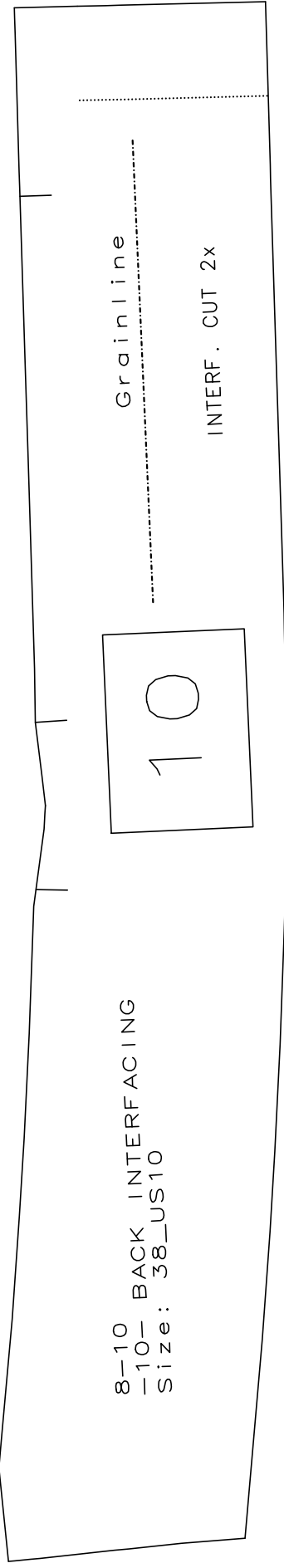
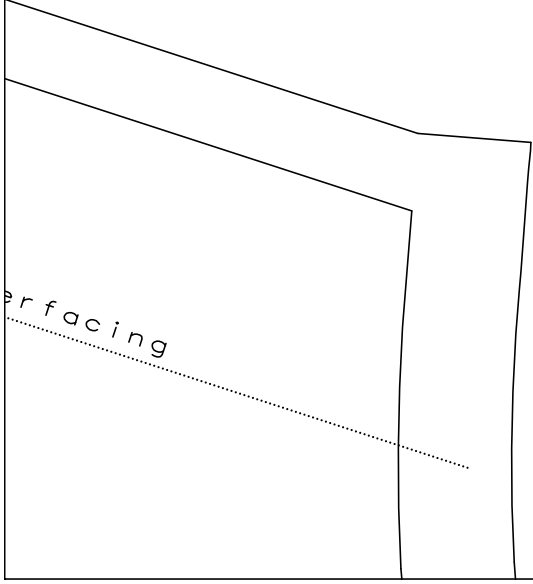

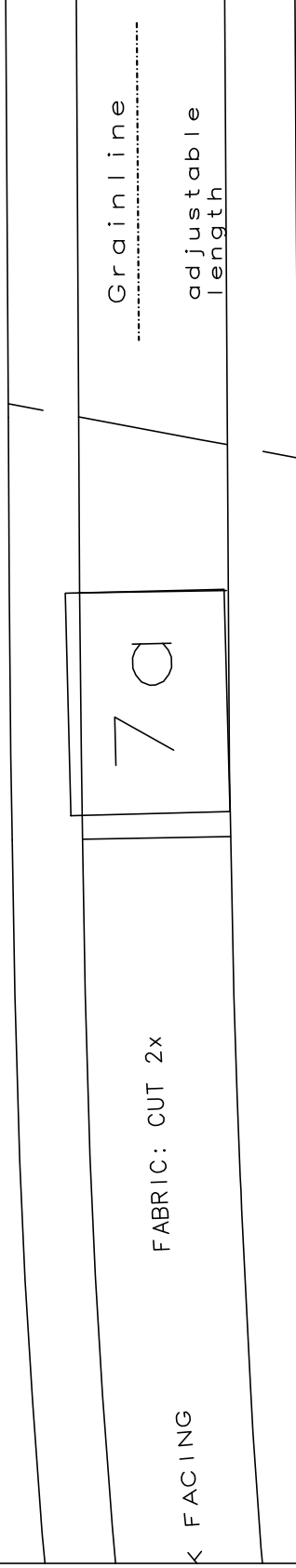
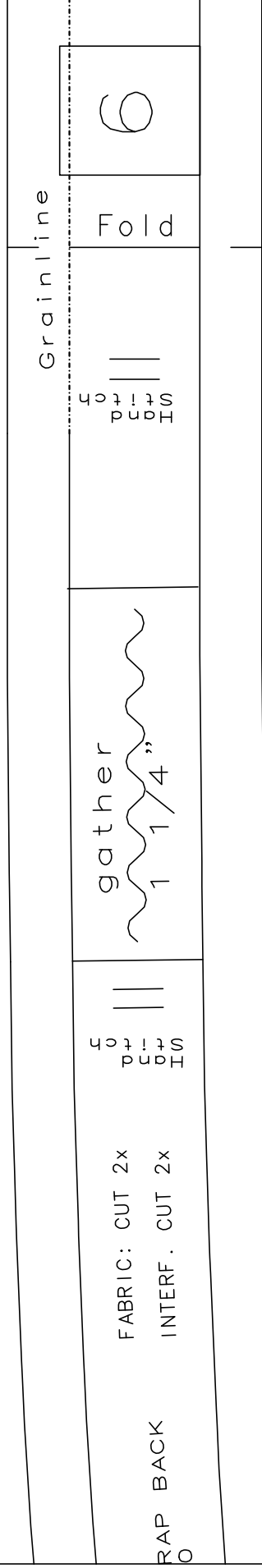

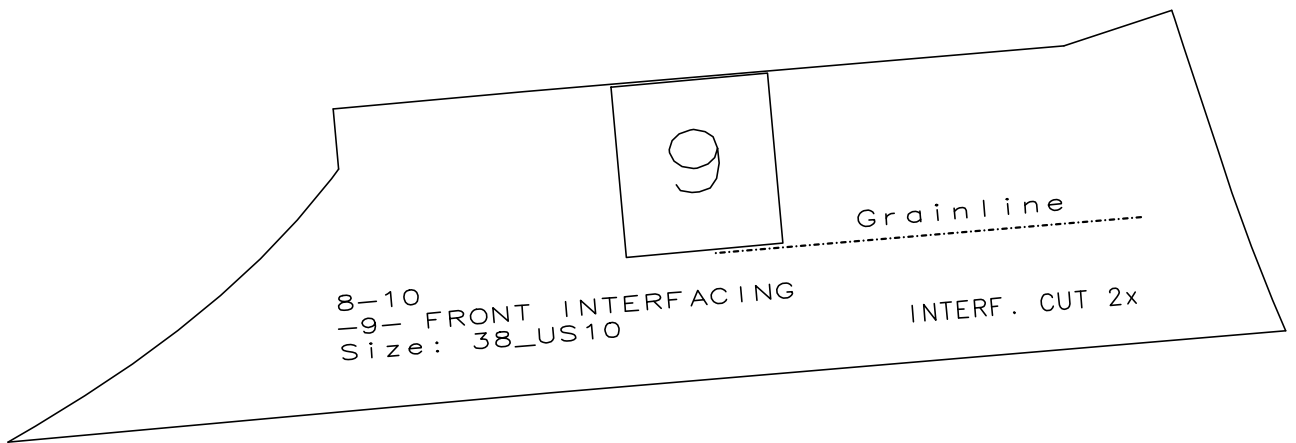

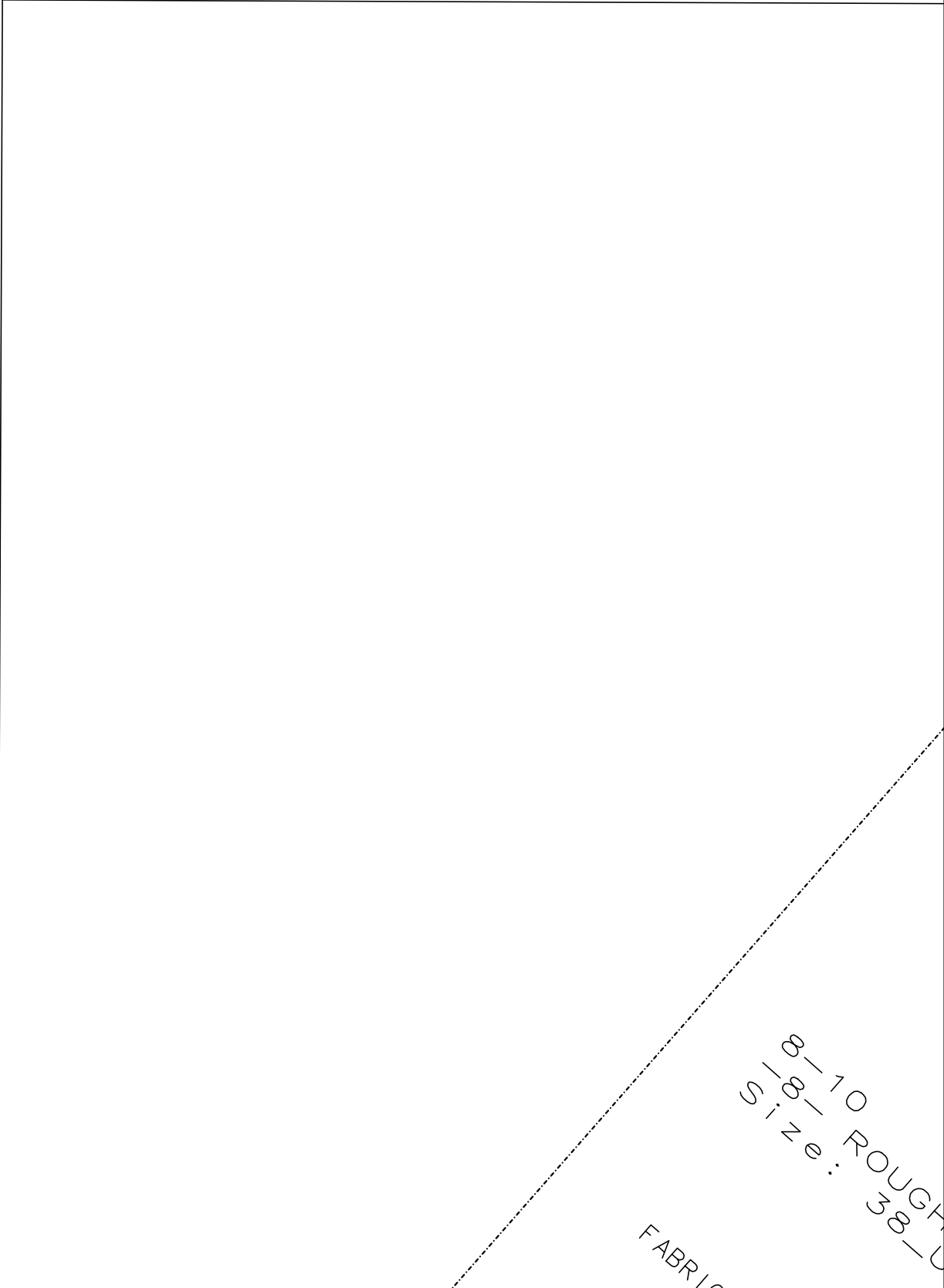

FABRIC

8-10 ROUGH
Size: 38-4

(c, 06) : 8-10.mdi

(.. \YSR\PDF\)

Grainline

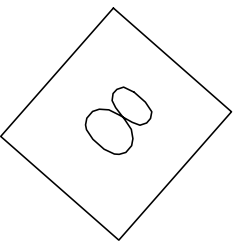

CS
x

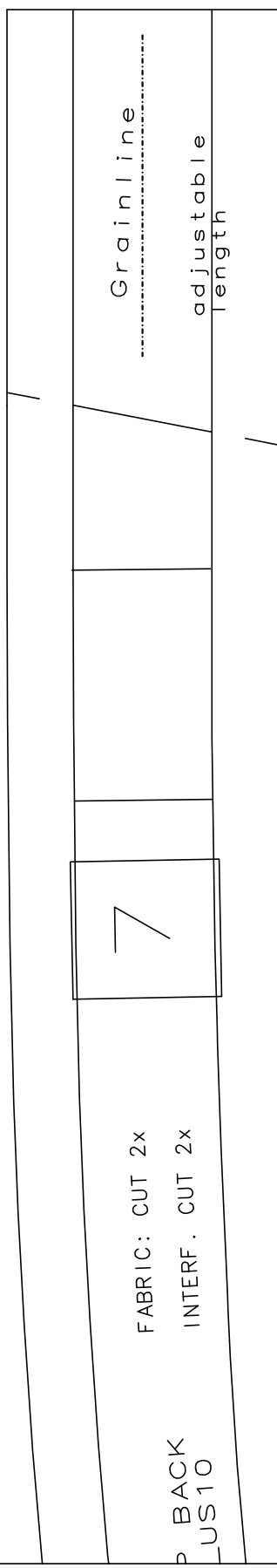
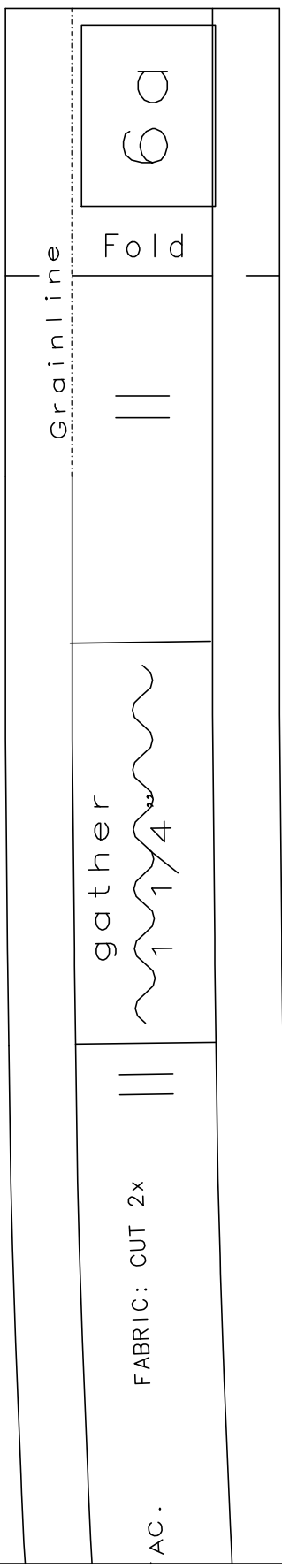

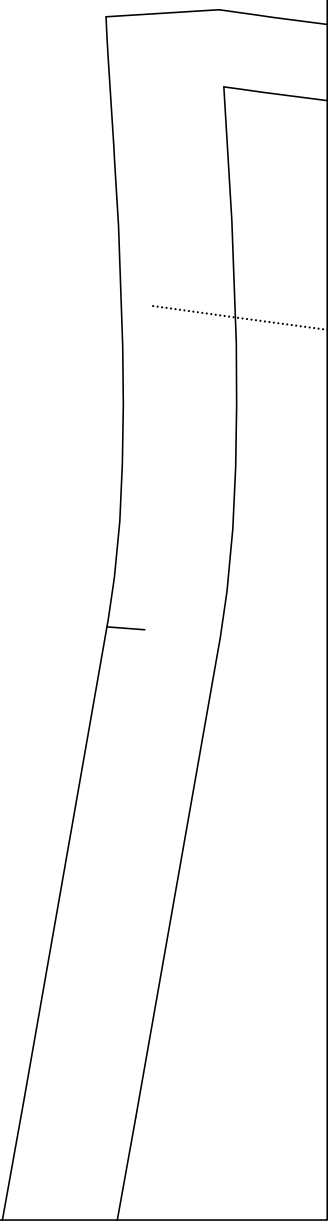
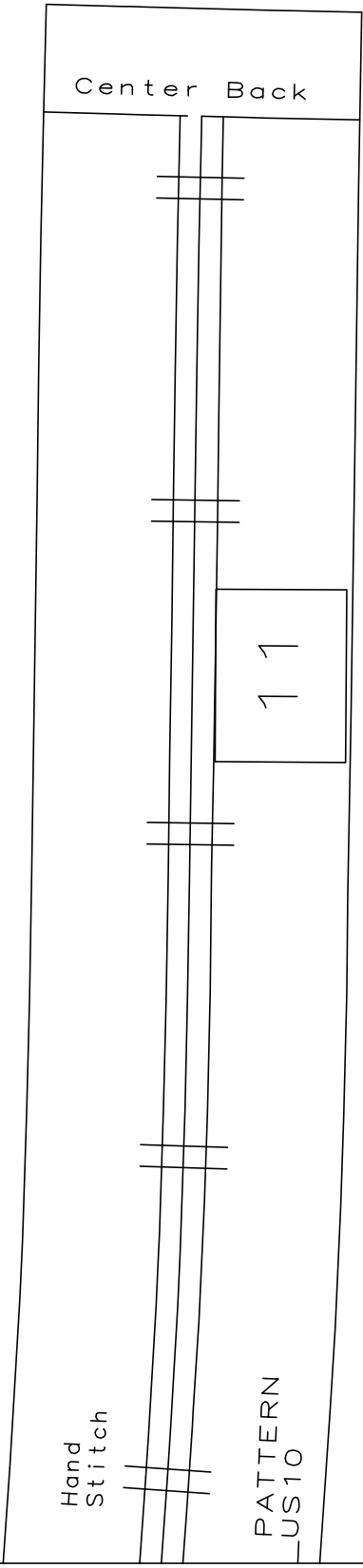

(C, 09) : 8-10.mdl (.. \YSR\PDF\)

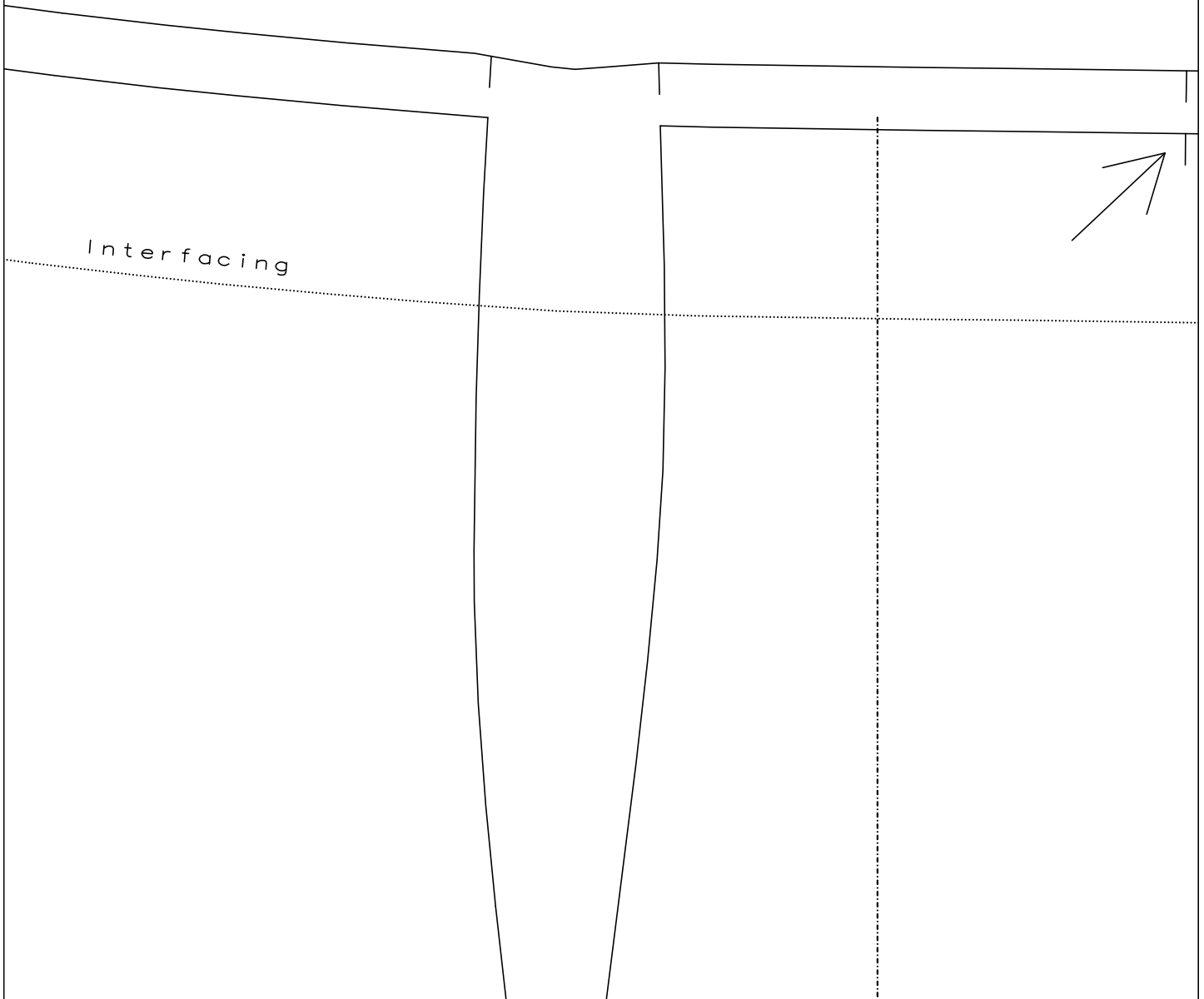

(c, 10) : 8-10.mdl (.. \YSR\PDF \)

