

burda Download-Schnitt

Modell 008 Easy Fashion E005

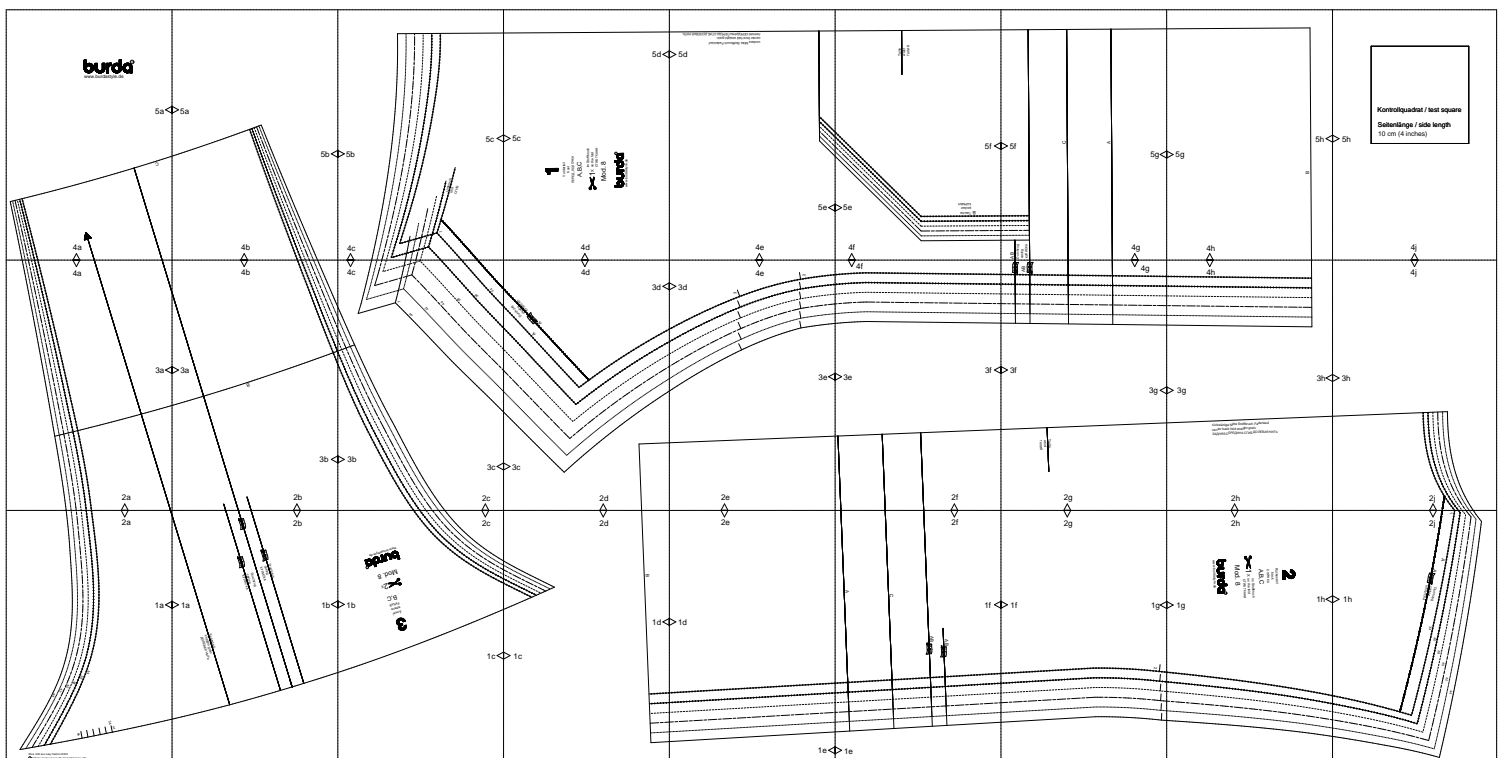

Copyright 2010 by Verlag Aenne Burda GmbH & Co. KG, Am Kestendamm 1, D-77652 Offenburg

Sämtliche Modelle, Schnittteile und Zeichnungen stehen unter Urberschutz, gewerbliches Nacharbeiten ist untersagt.

Der Verlag haftet nicht für Schäden, die durch unsachgemäße Handhabung des Schnitts, der Materialien, unsachgemäße Ausführung der Tipps und Anleitungen oder unsachgemäße Nutzung der Modelle entstehen.

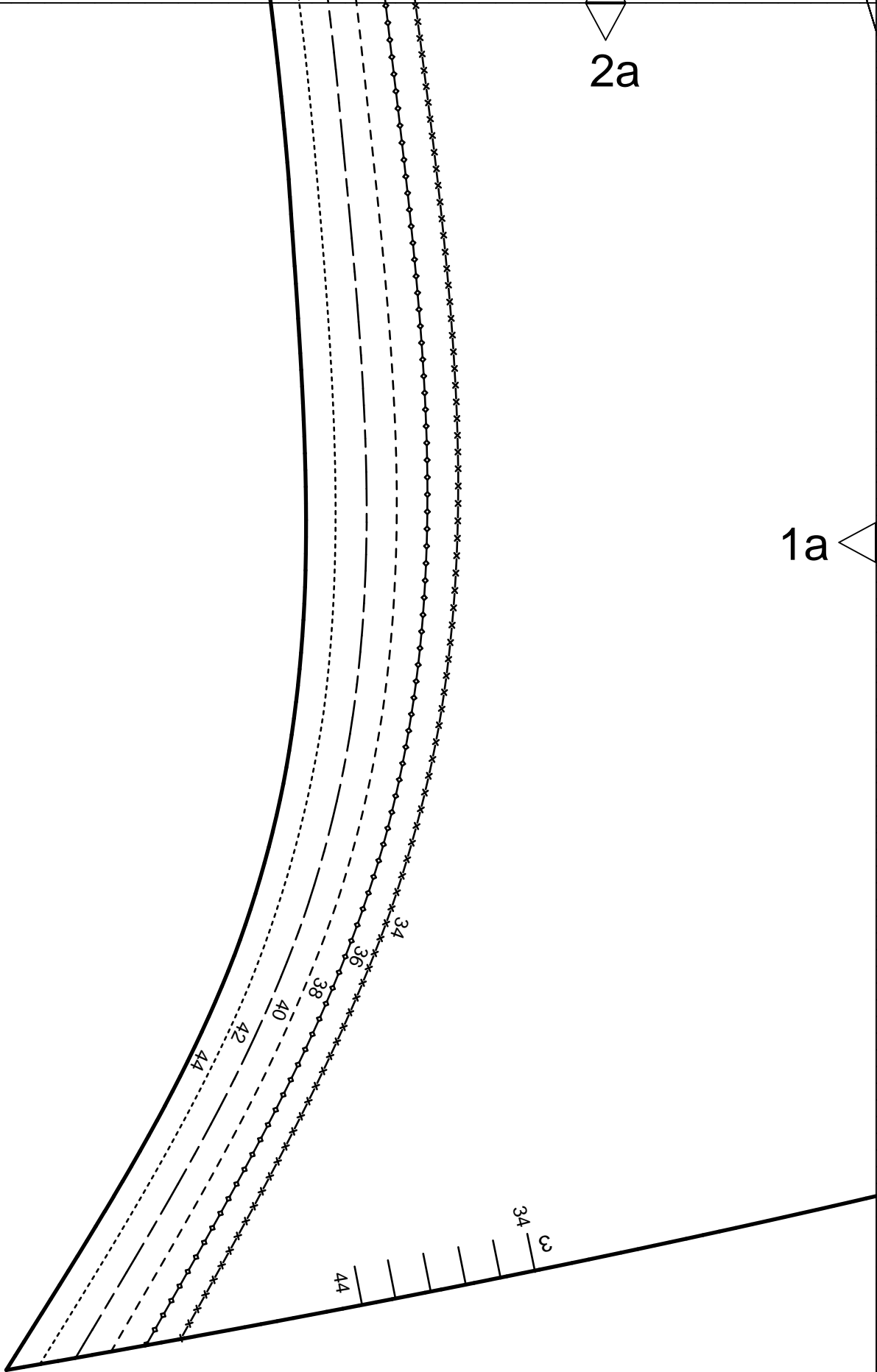

Mod. 008 aus easy fashion E005

© 2010 by Verlag Aenne Burda GmbH & Co. KG

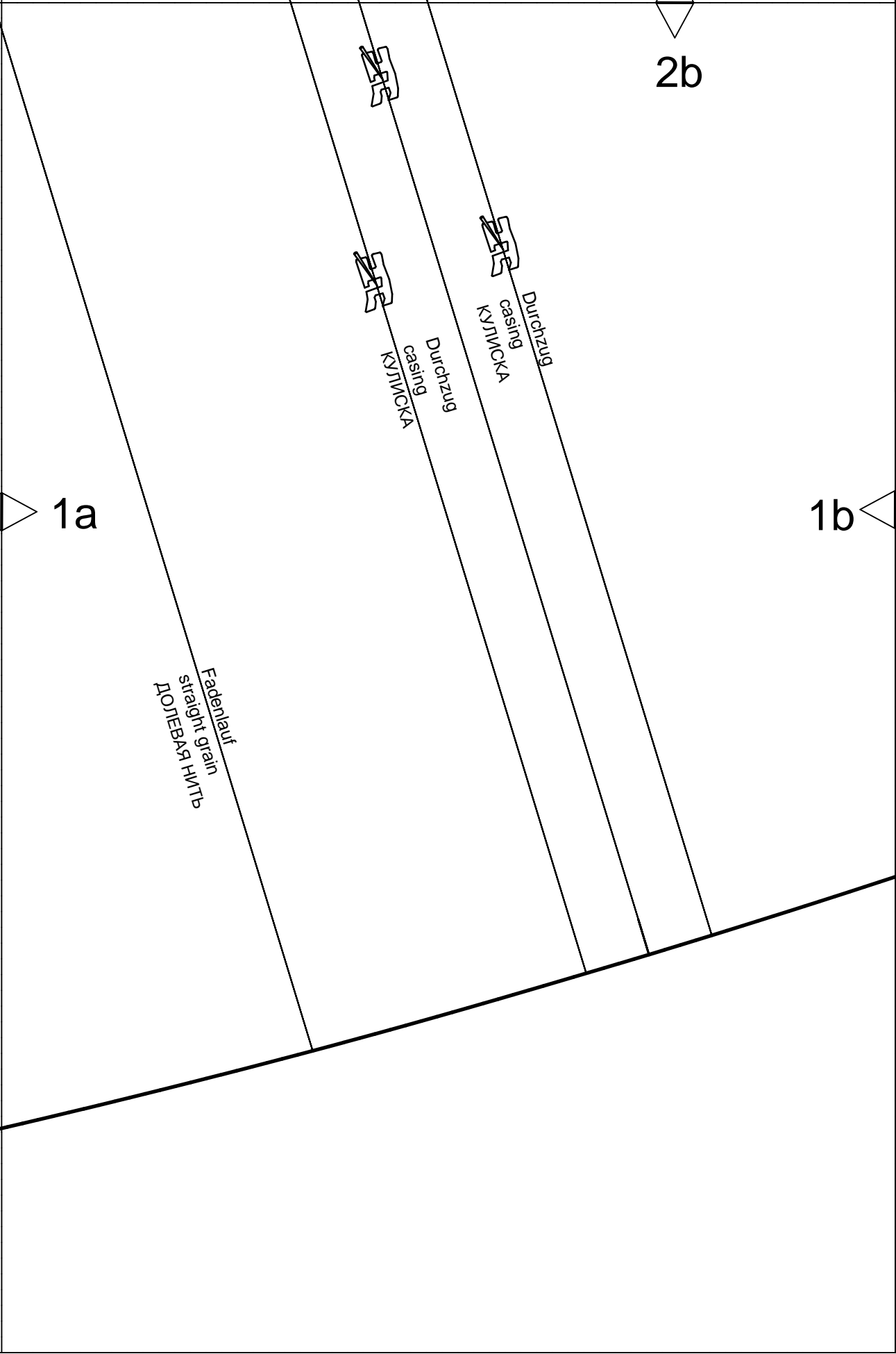

burda
®
www.burdastyle.de

Mod. 8



Ärmel
sleeve
PYKAB
B,C

3

1b

2c

1c

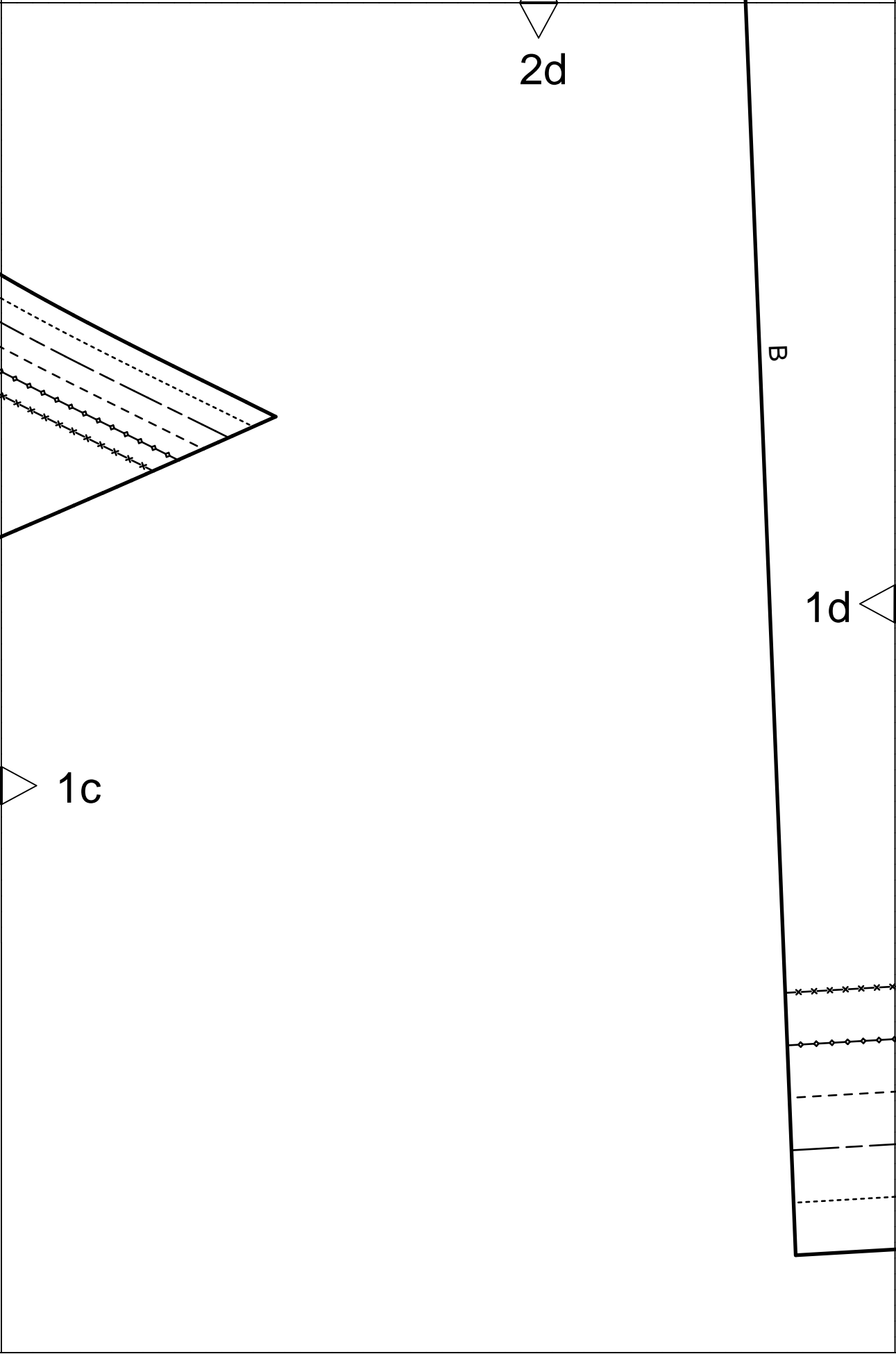

2e

1d

1e

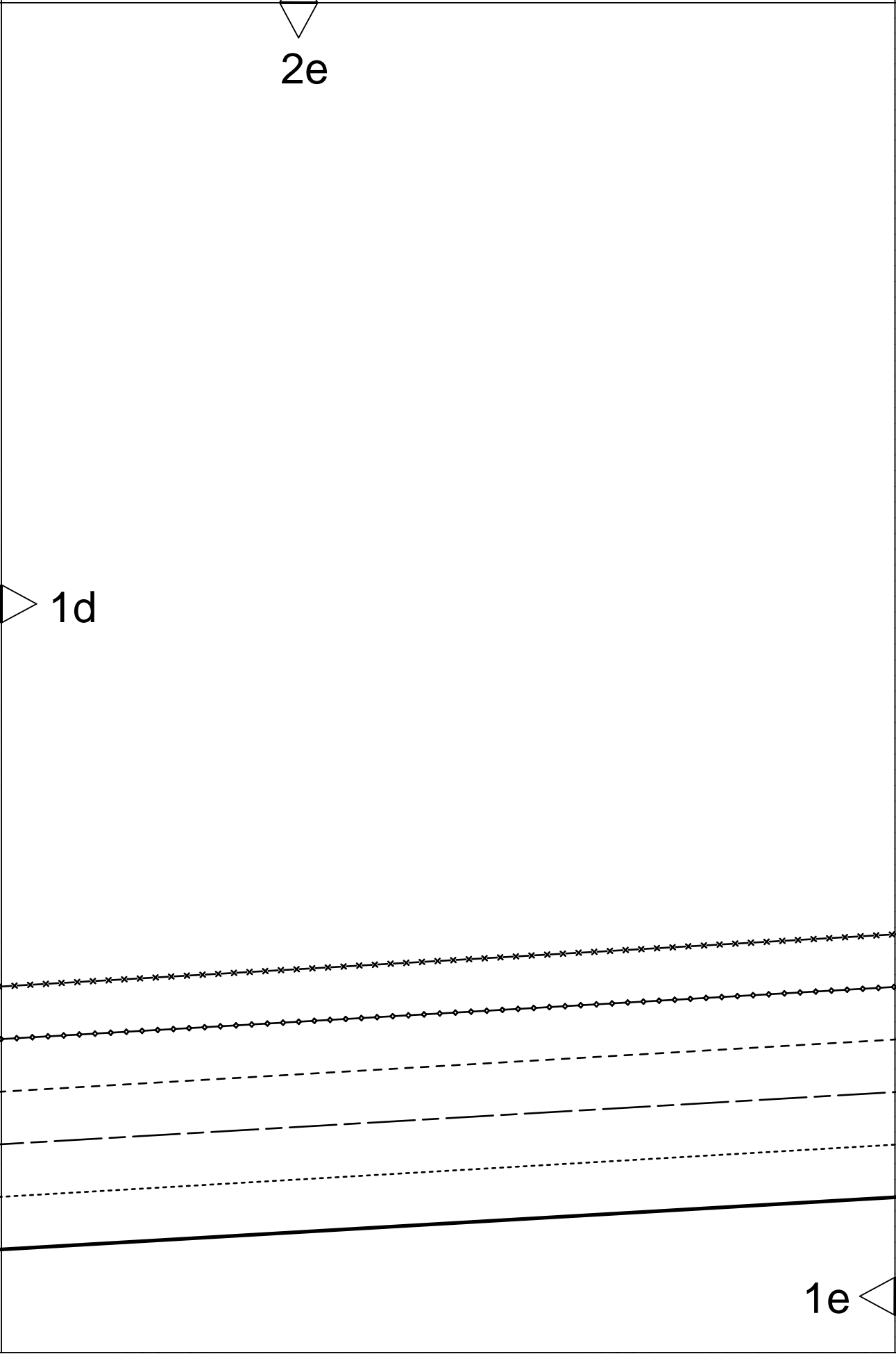

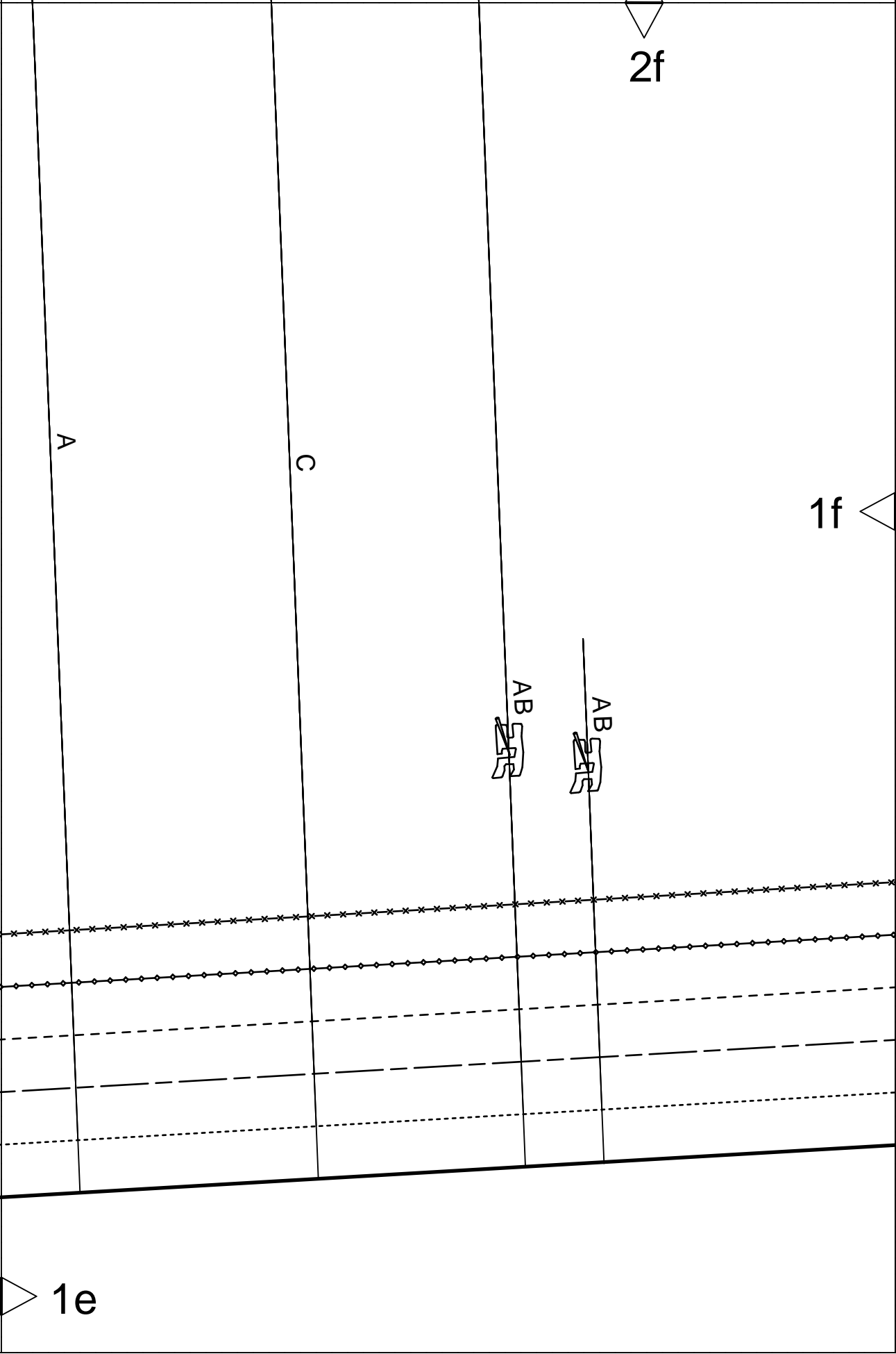

2g

1f

1g

2

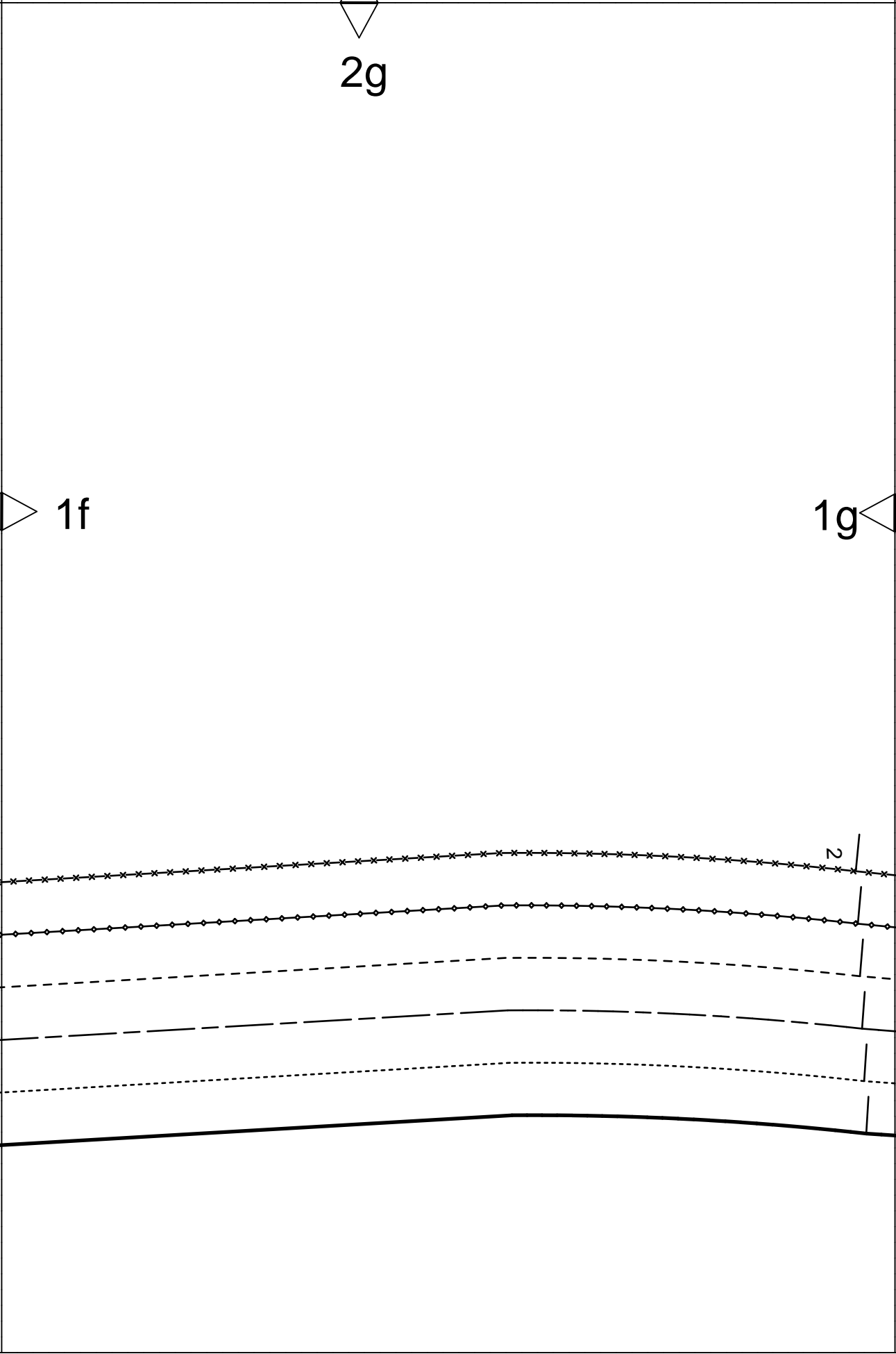

1h

2

Rückenteil
back
СПИНИКА
A, B, C

im Stoffbruch
on the fold
СТИБ ТКАНИ



Mod. 8

burda[®]
www.burdastyle.de

2h

1g

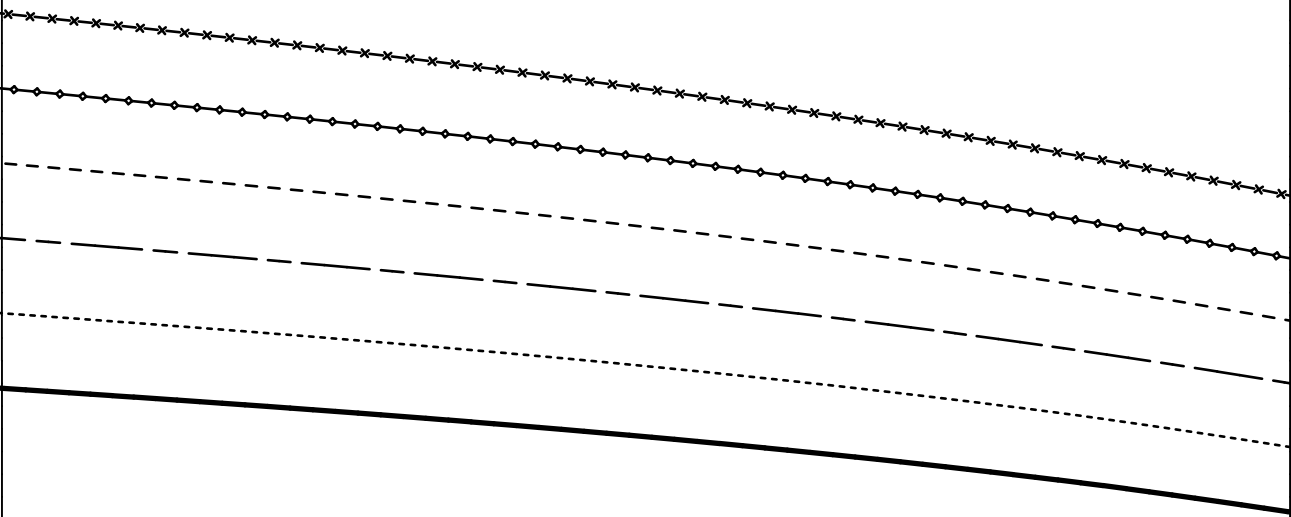

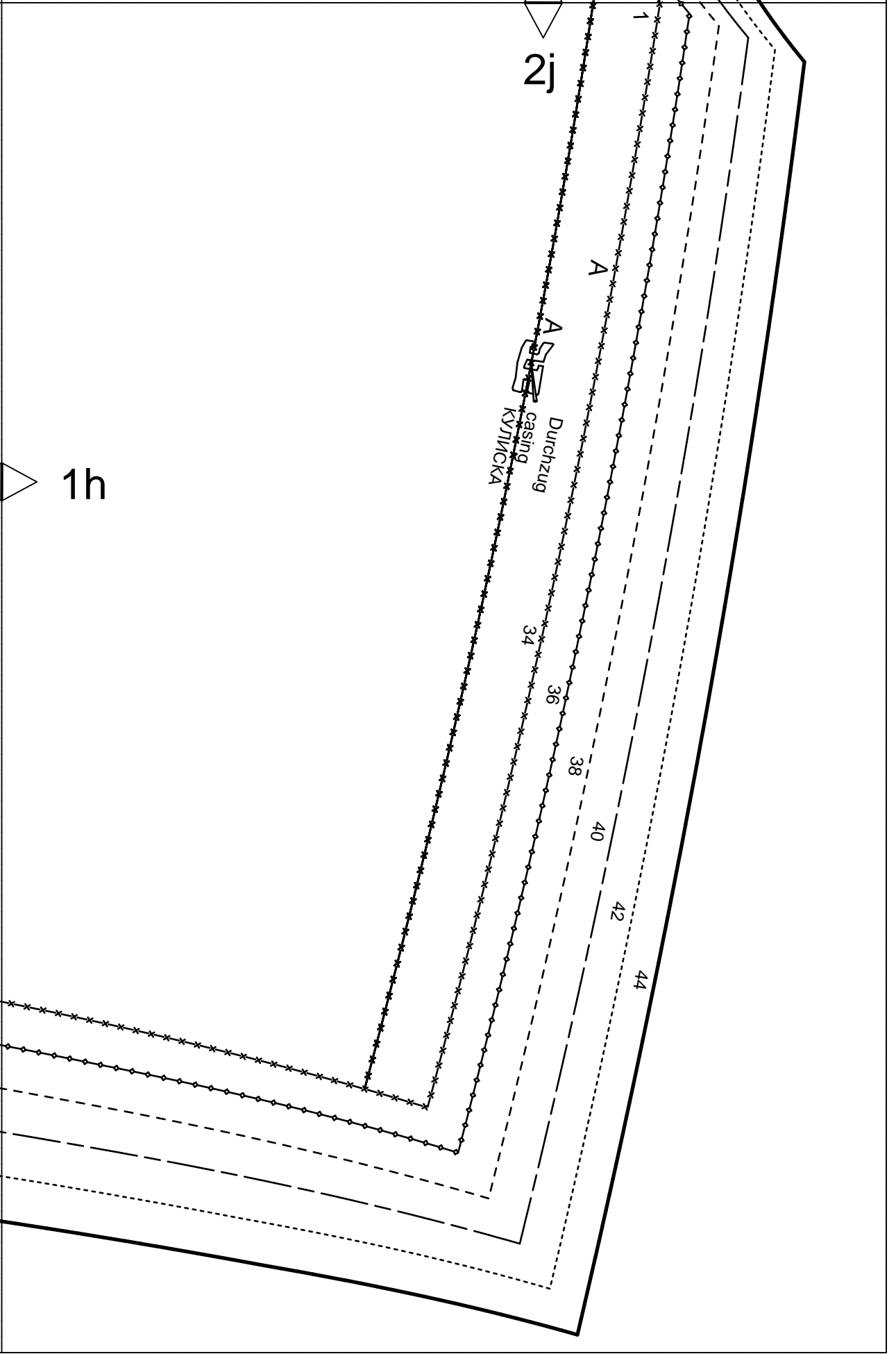

1h

2j

A
Durchzug casing
KVTMCKA

34

36

38

40

42

44

1

A

A

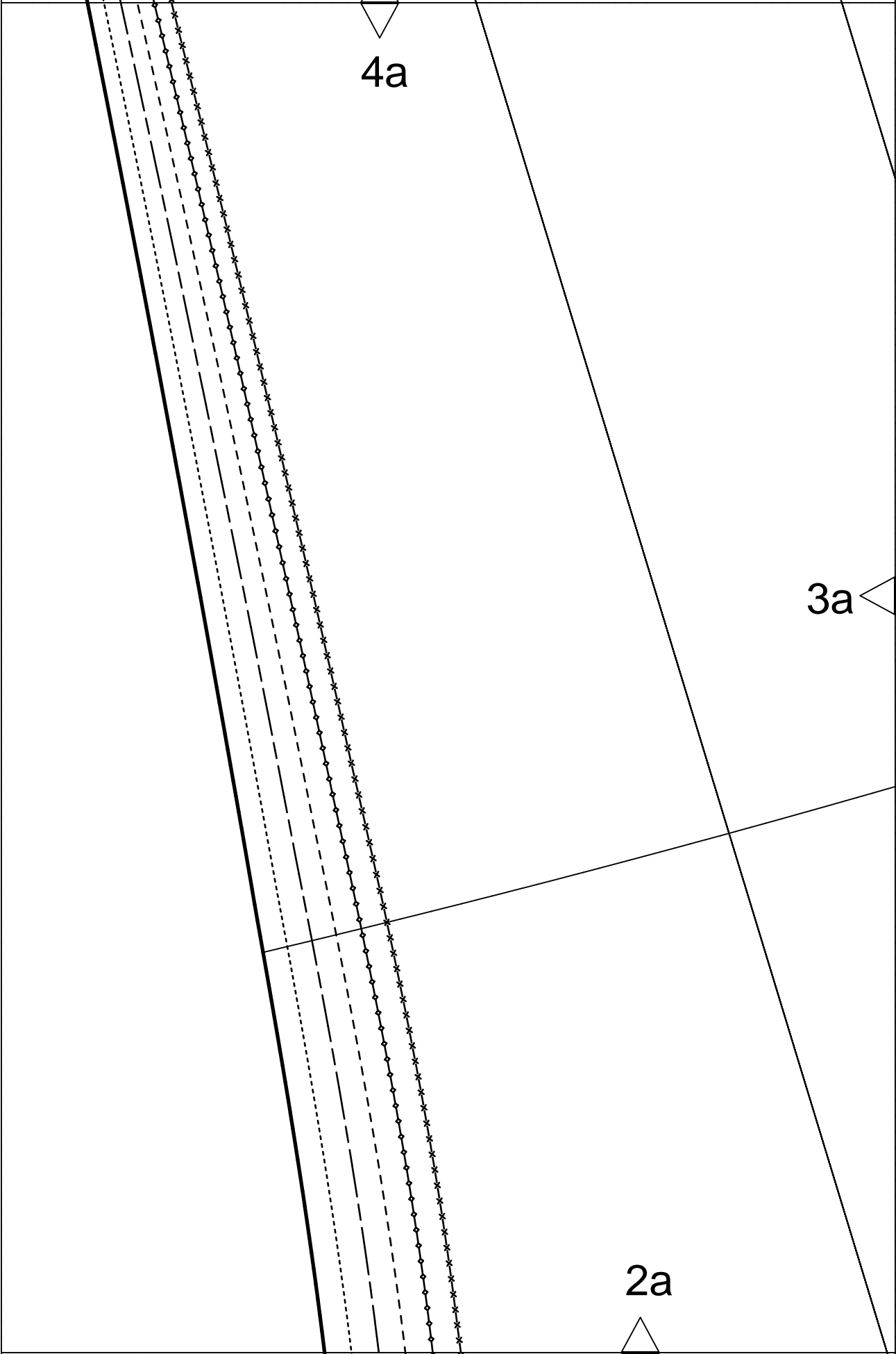

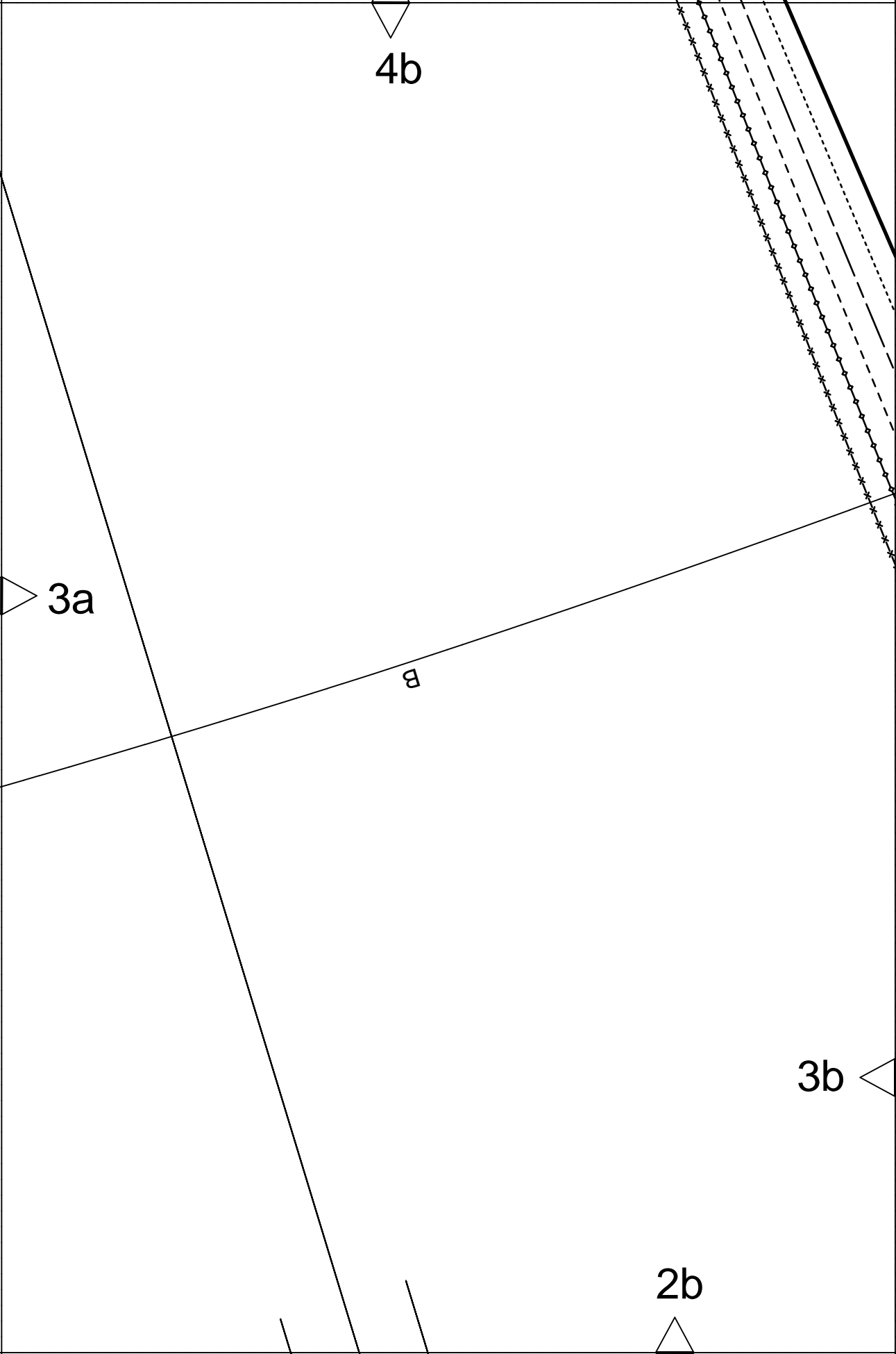

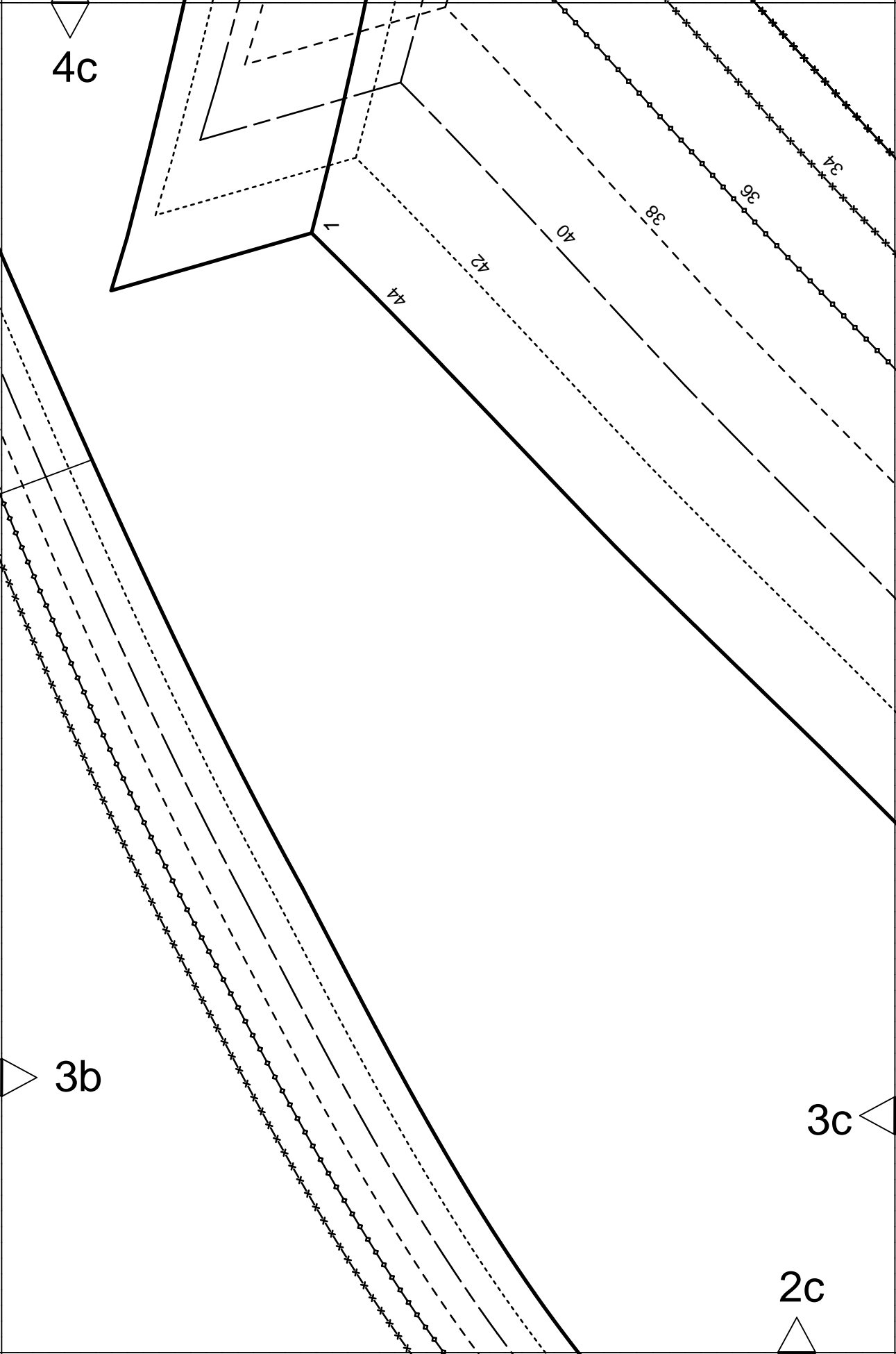

4c

34

36

38

40

42

44

3b

3c

2c

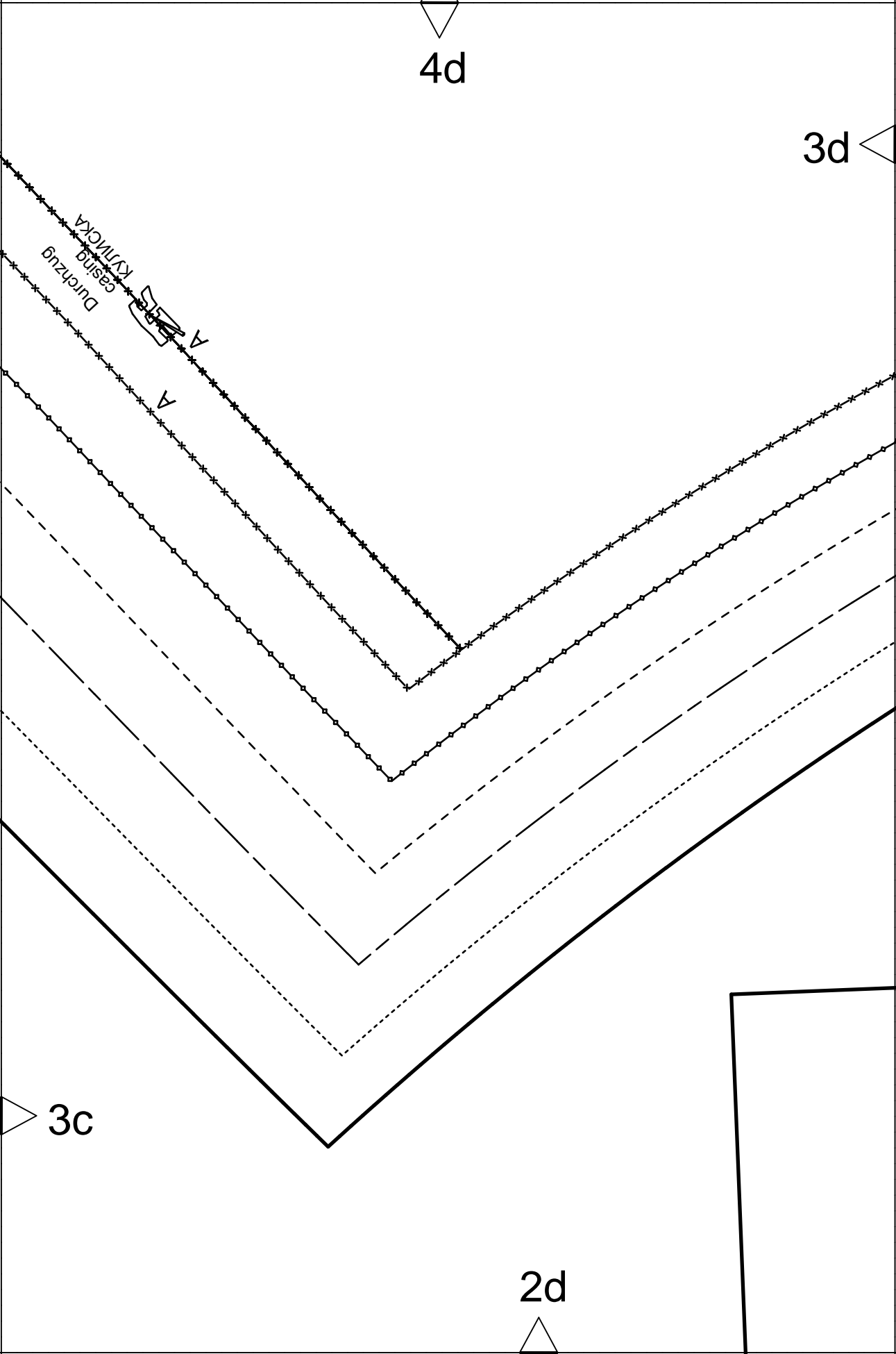

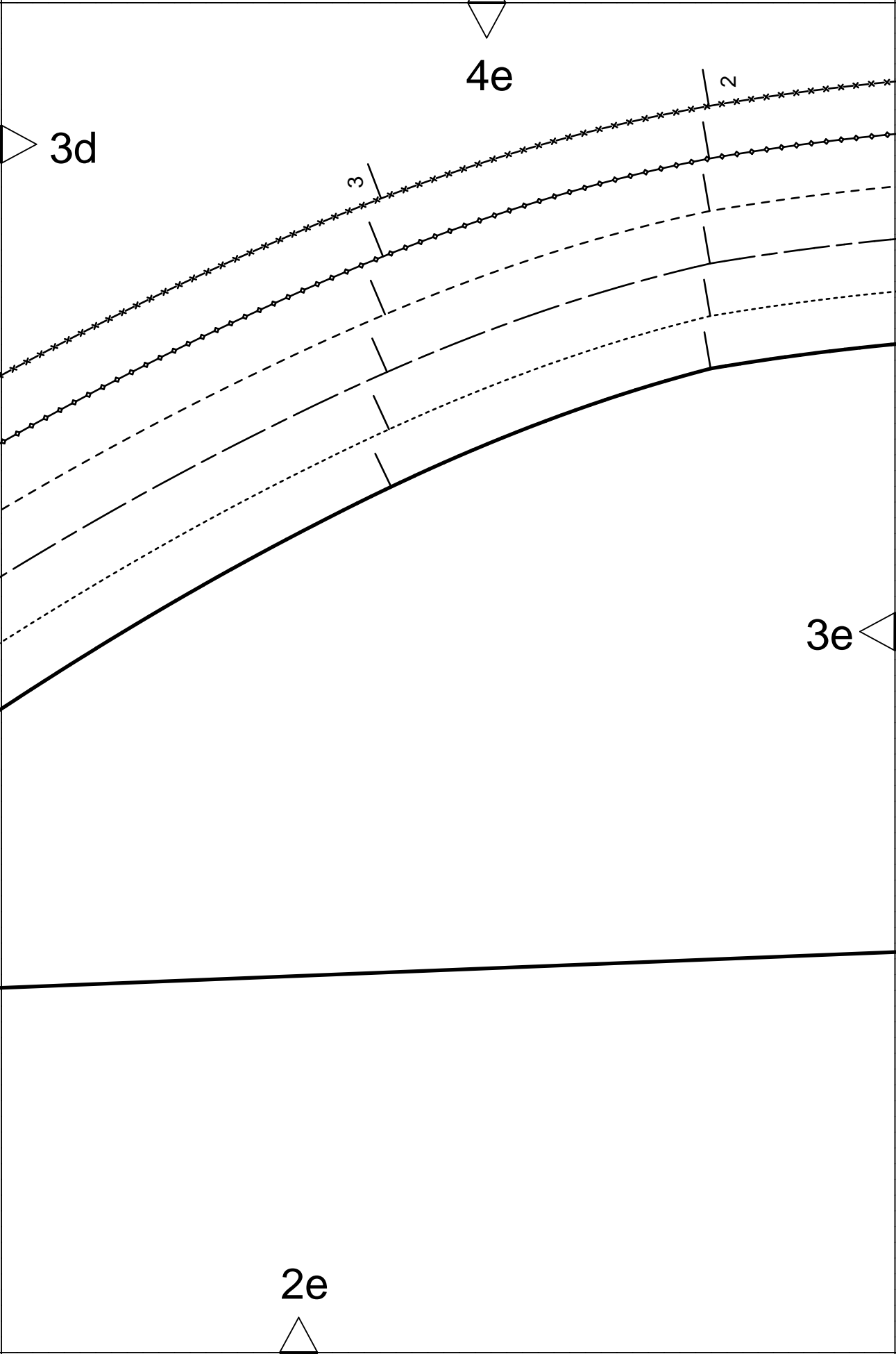

4f

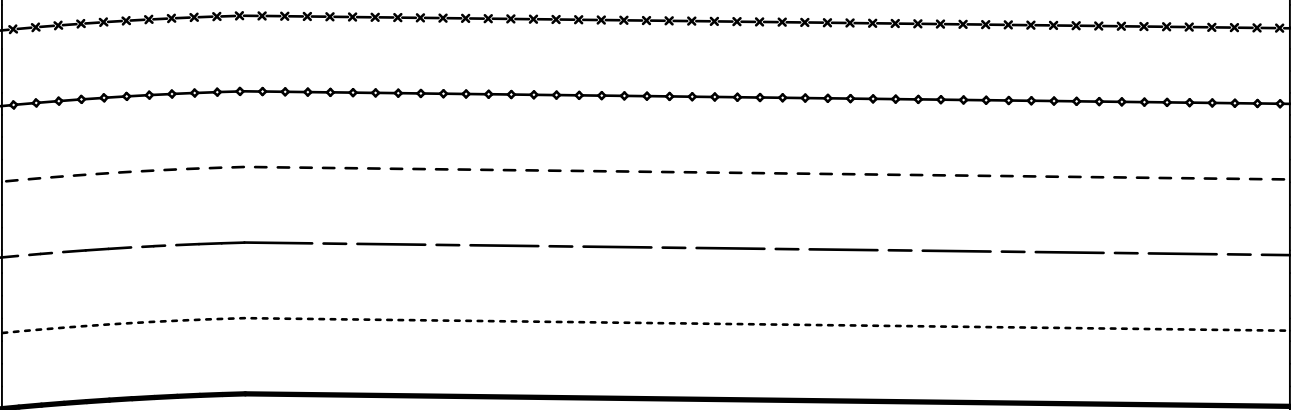

3e

3f

2f

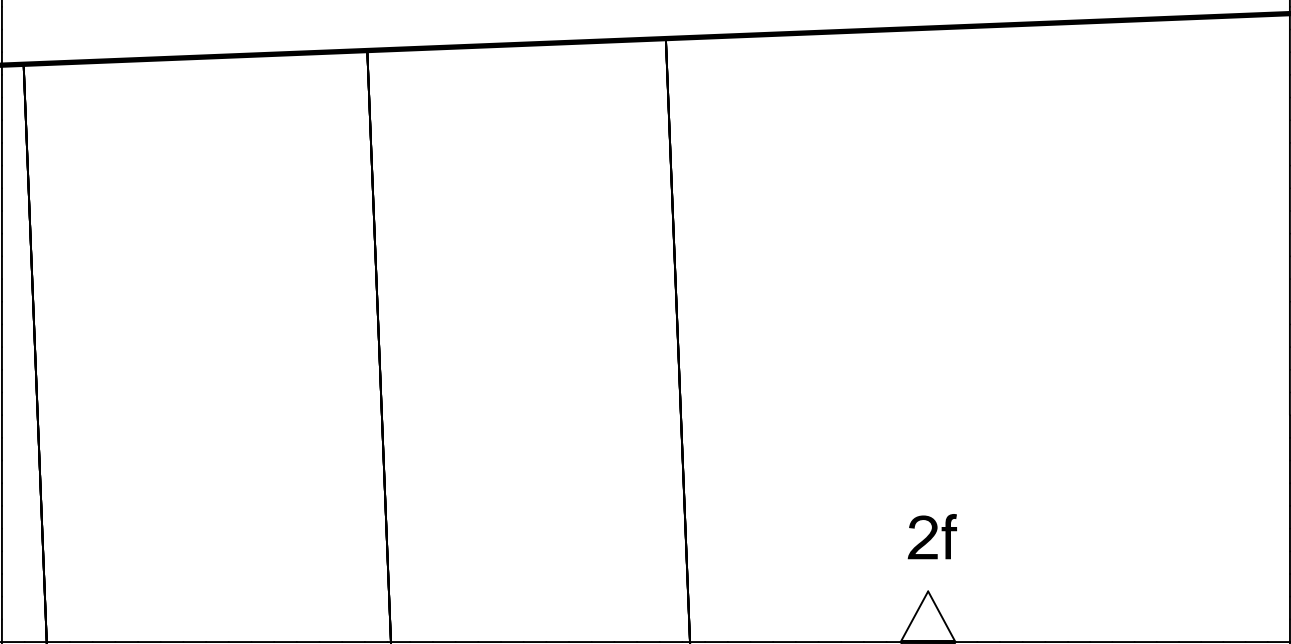

СРС AB СРС

4g

3f

3g

Taille
waist
ТАЛИЯ

2g

4h

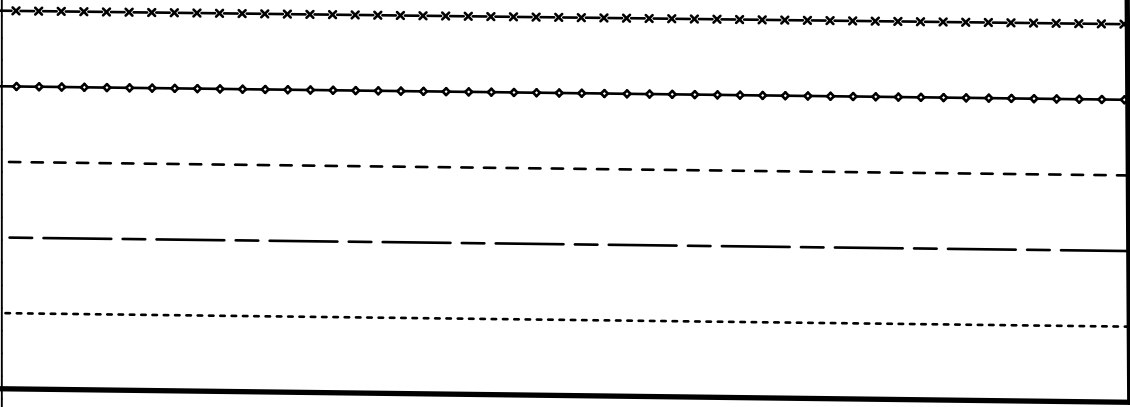

3h

3g

rückwärtige Mitte Stoffbruch Fadenlauf
center back fold straight grain
ЗАДНЯЯ СЕРЕДИНА СГИБ ДОЛЕВАЯ НИТЬ

2h

4j

3h

2j

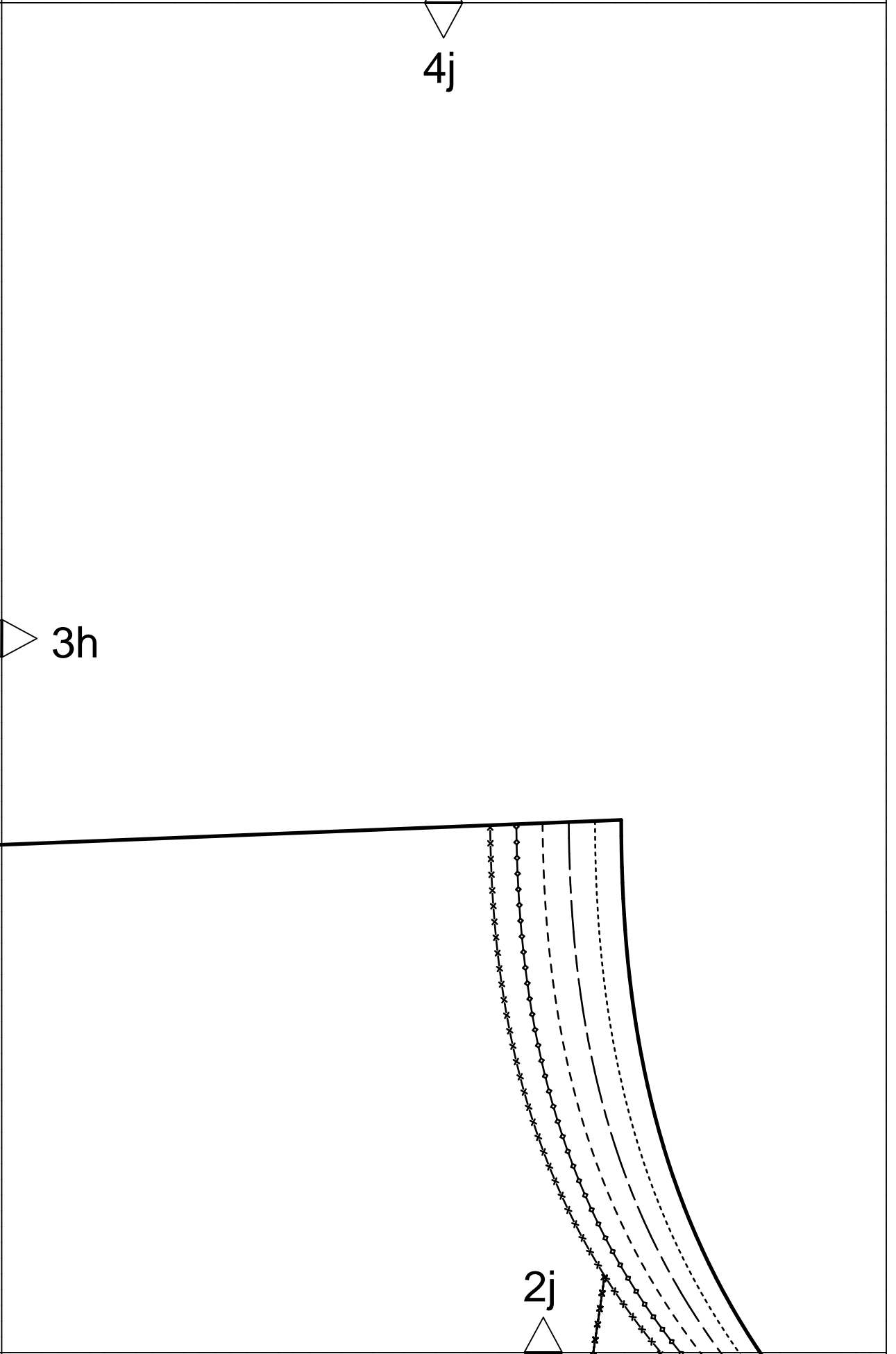

burda[®]
www.burdastyle.de

5a

3

4a

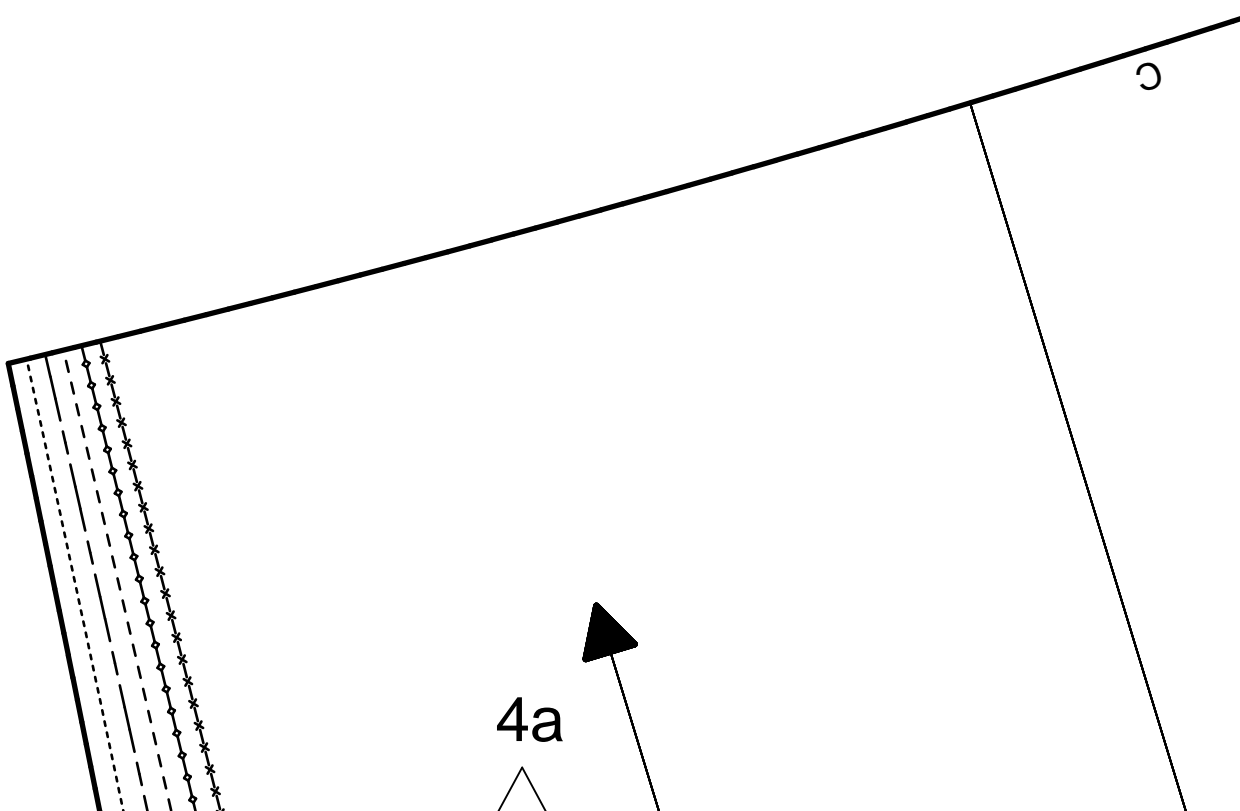

5a

5b

4b

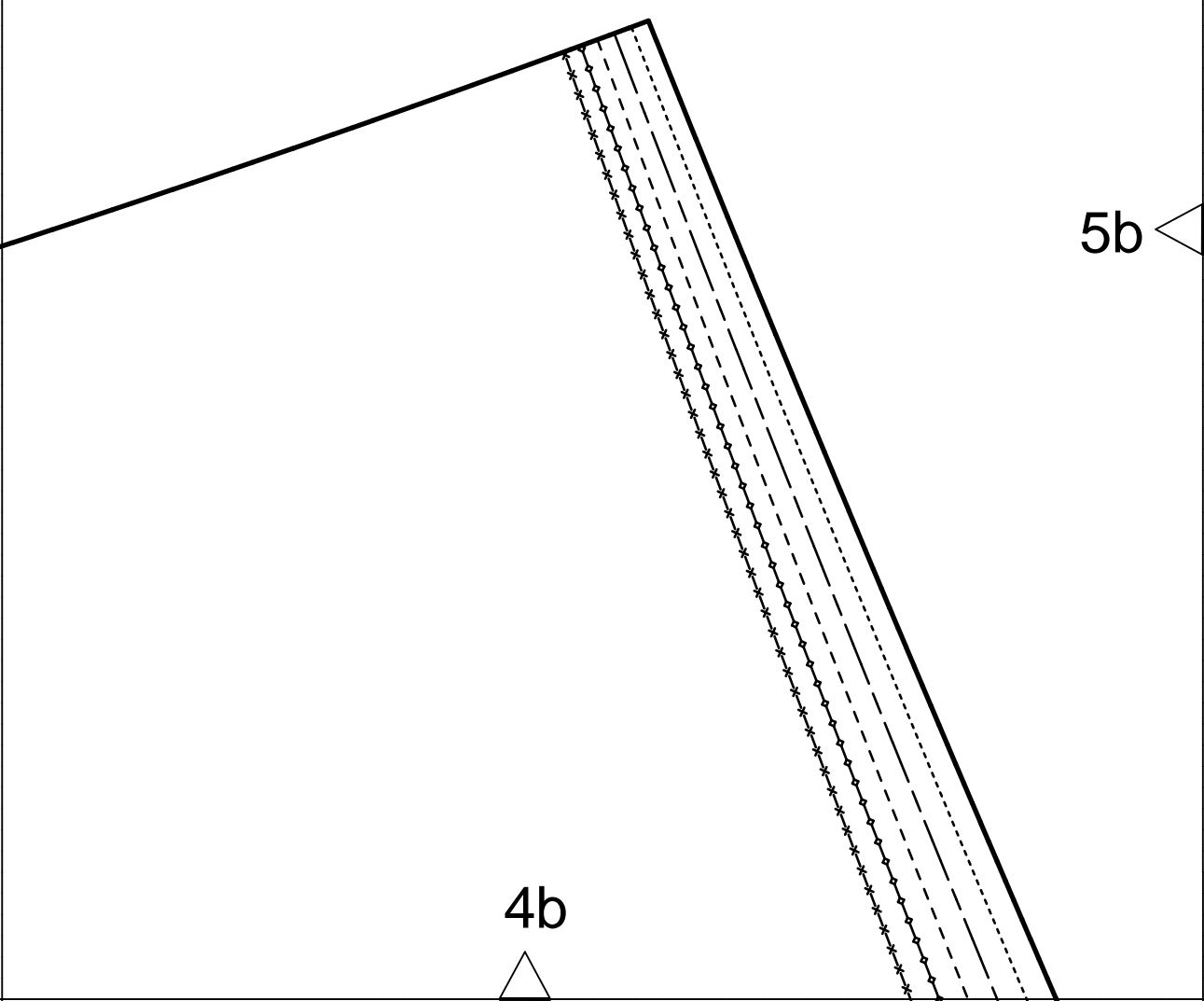

5b

5c

4c

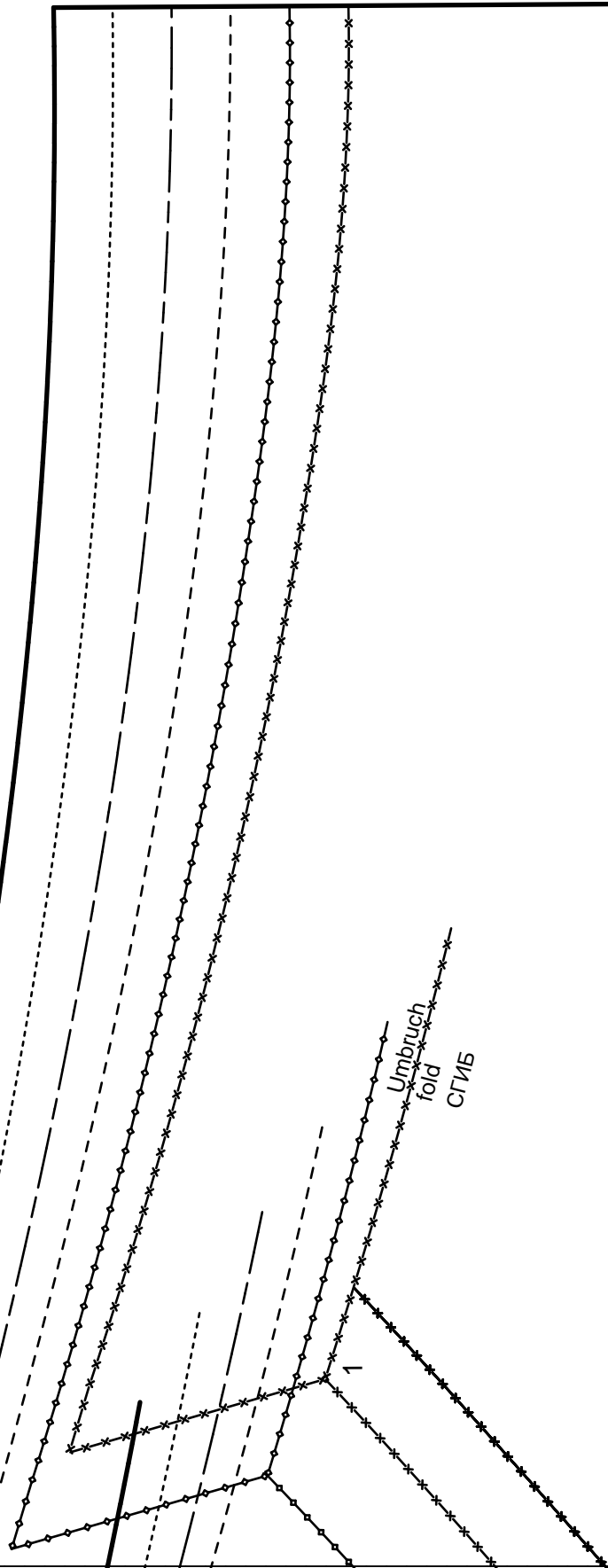

1

Vorderteil
front

ПЕРЕД, ПОЛОЧКА

A, B, C

 1X
im Stoffbruch
on the fold
СГИБ ТКАНИ

Mod. 8

burda[®]
www.burdastyle.de

5c

5d

4d

Линия середины передая часть долевая нить
center front fold straight grain
vordere Mitte Stoffbruch Fadenlauf

5d

5e

4e

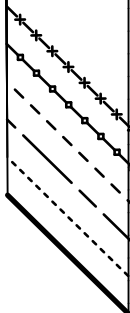

Taille
waist
ТАЛИЯ

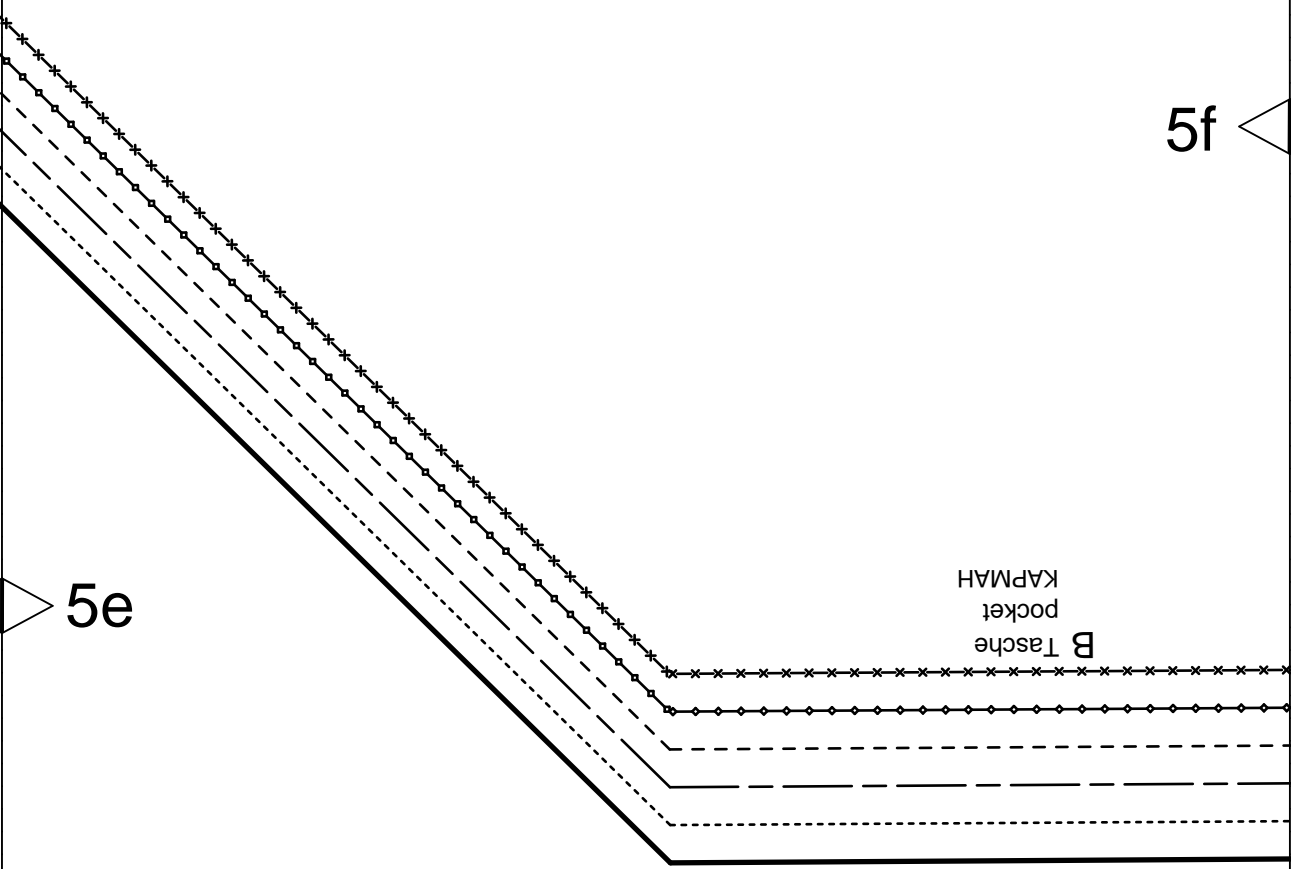

5e

4f

5f

B Tasche
pocket
КАРМАН

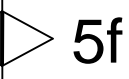

5f

C

A

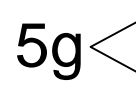

5g

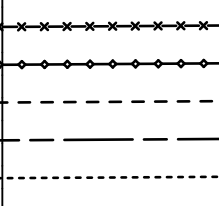

AB

Durchzug
 casing
 КУЛИСКА

4g



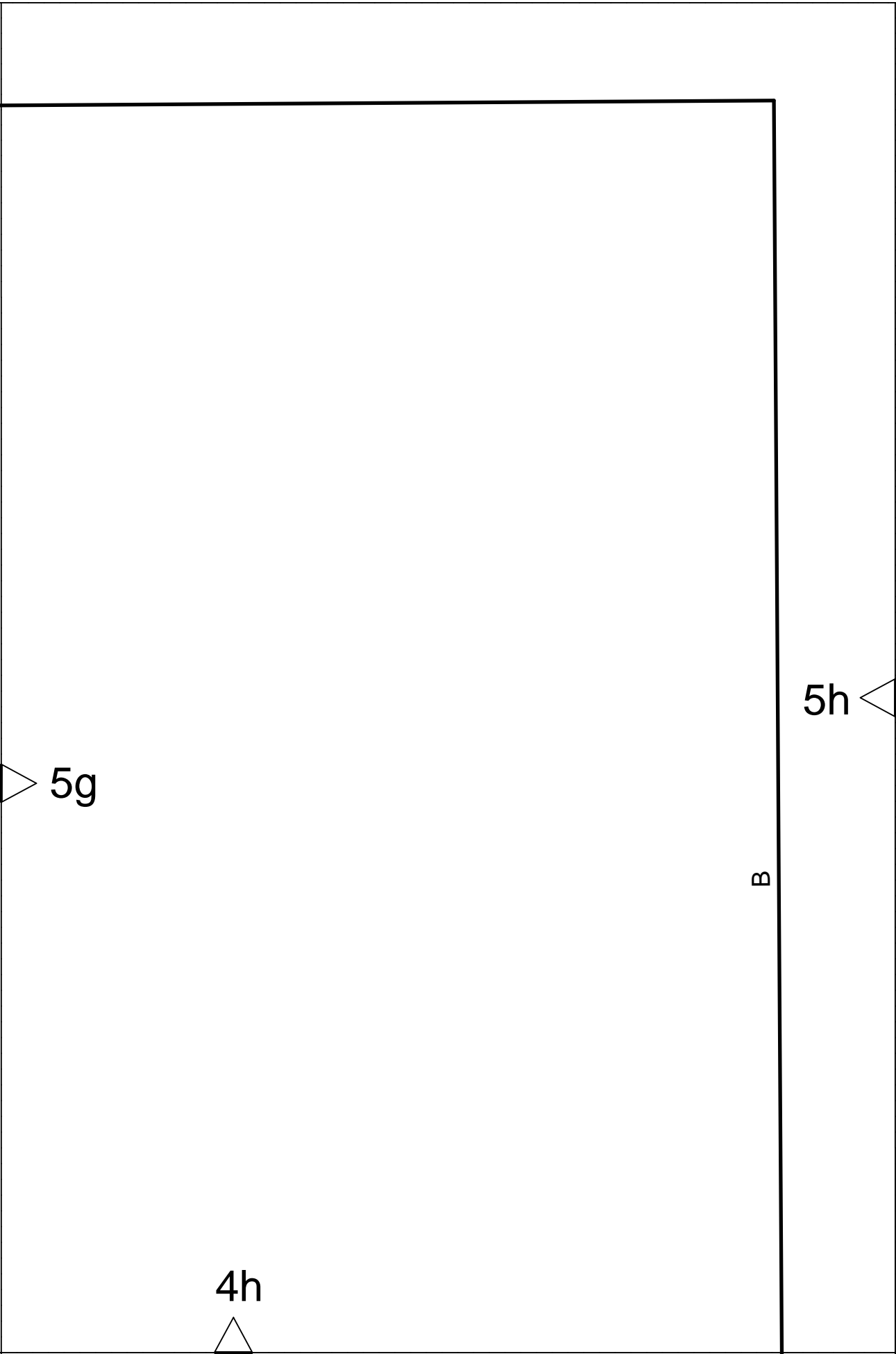



Kontrollquadrat / test square

Seitenlänge / side length
10 cm (4 inches)

5h

4j