

POLLY PYJAMA SHIRT PATTERN

Use these guides to get started today

IN YOUR PRINT MENU, UNDER SIZE OPTIONS, BE SURE TO
SELECT '**ACTUAL SIZE**', INSTEAD OF 'FIT TO PAGE'

Title: Polly Pyjama Shirt
Designer: Amanda Walker
Magazine page: 32



POLLY PYJAMA SHIRT PATTERN LAYOUT

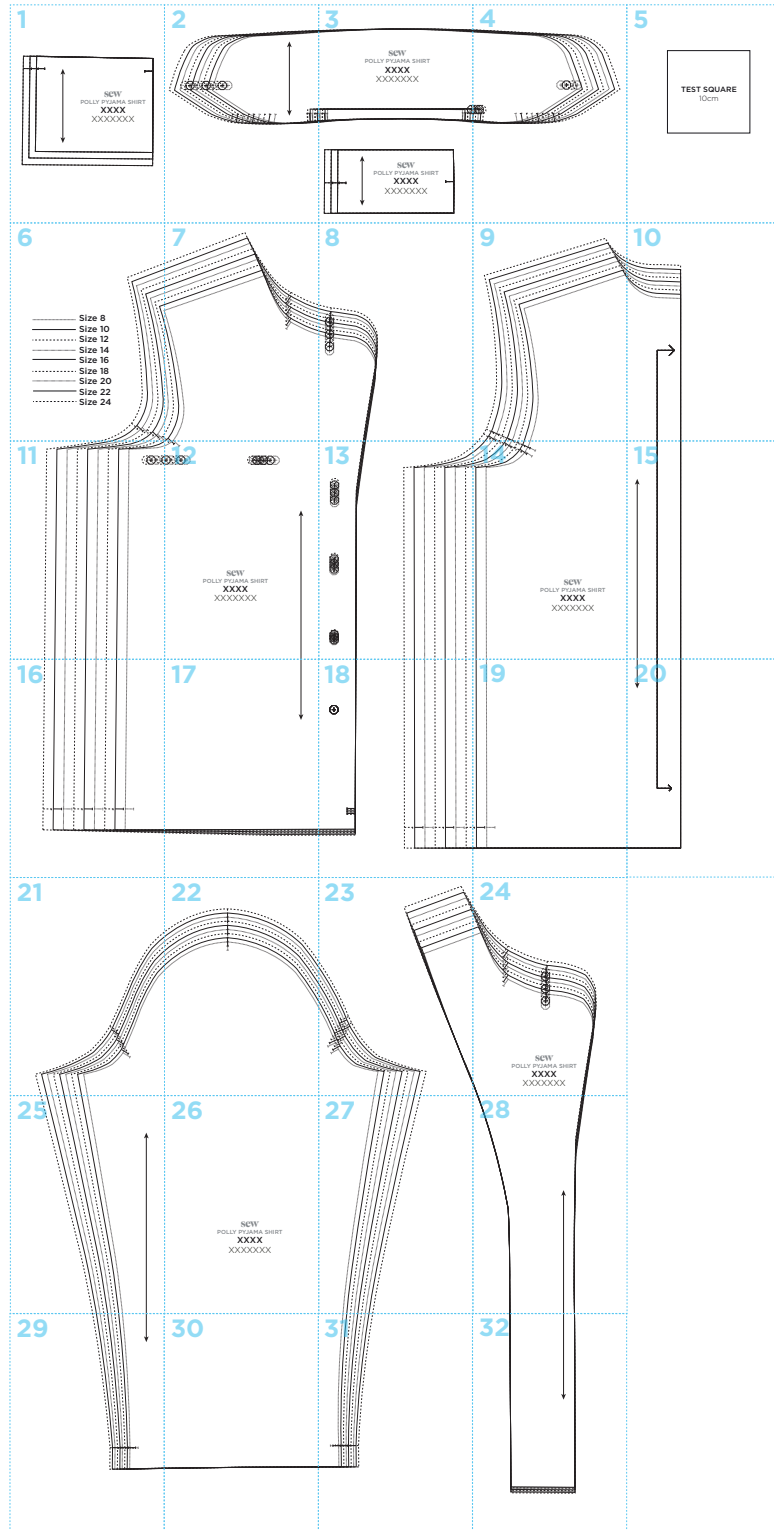

Once you have your body measurements, choose the closest size from the chart below. Remember, there will be variations depending on which fabric and pattern you choose, so always make a toile first.

	8	10	12	14	16	18	20	22	24
Bust	78cm	83cm	88cm	93cm	98cm	103cm	108cm	113cm	118cm
Waist	59cm	64cm	69cm	74cm	79cm	84cm	89cm	94cm	99cm
Hip	85cm	88cm	93cm	98cm	103cm	108cm	113cm	118cm	123cm
Back neck to waist	39cm	40cm	41cm	42cm	43cm	44cm	45cm	46cm	47cm

1

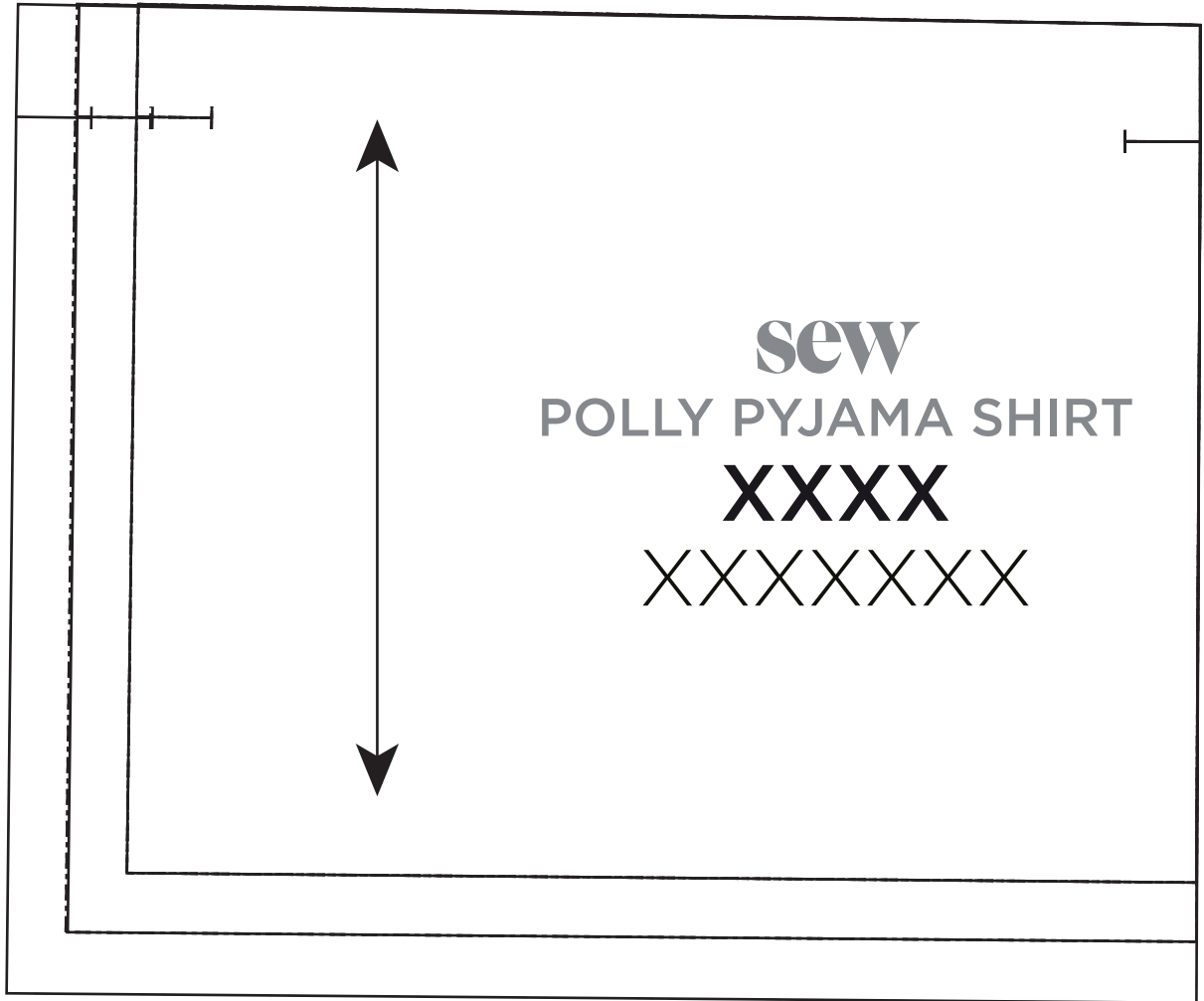

2

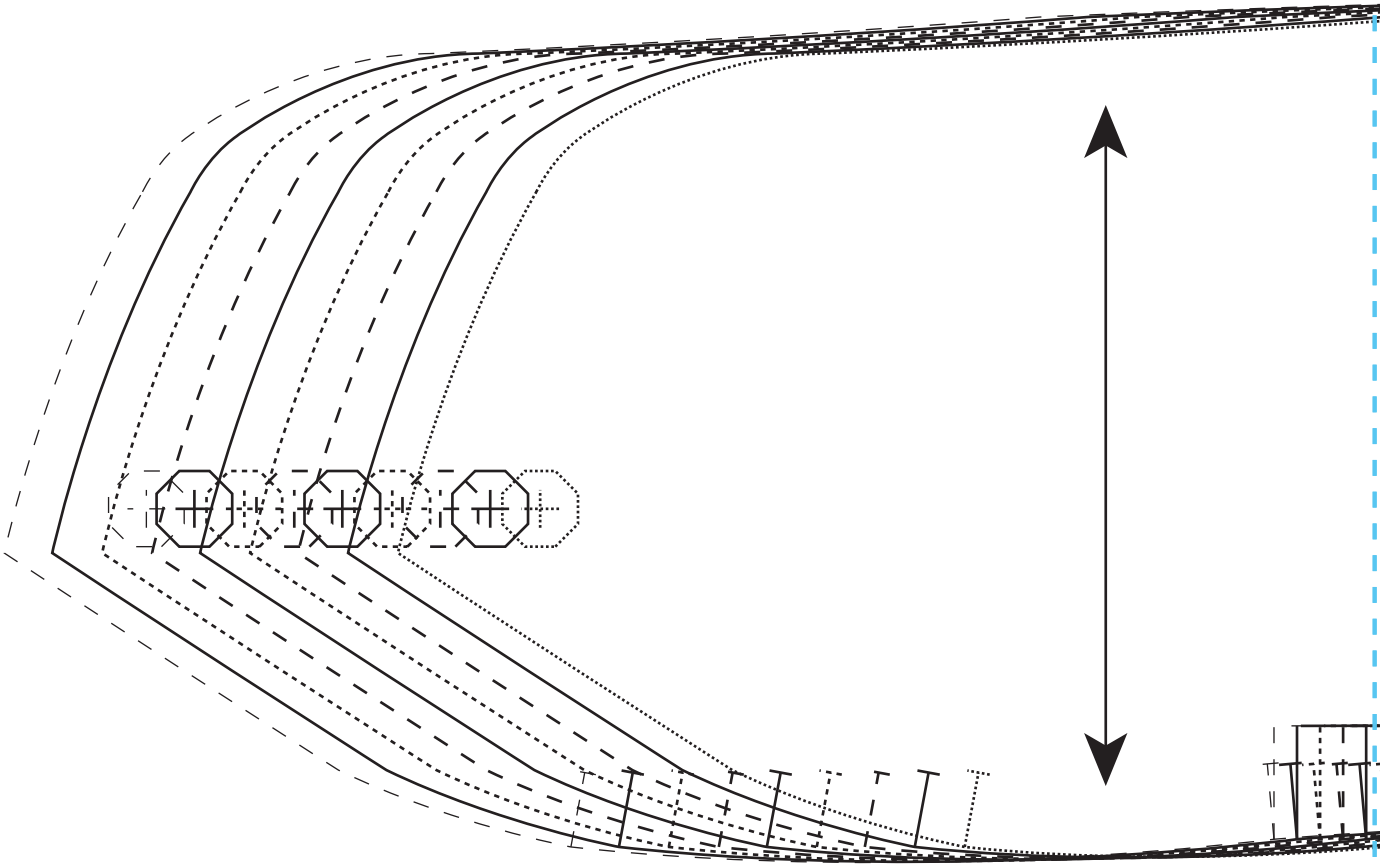

3

sew
POLLY PYJAMA SHIRT
XXXX
XXXXXXXXXX

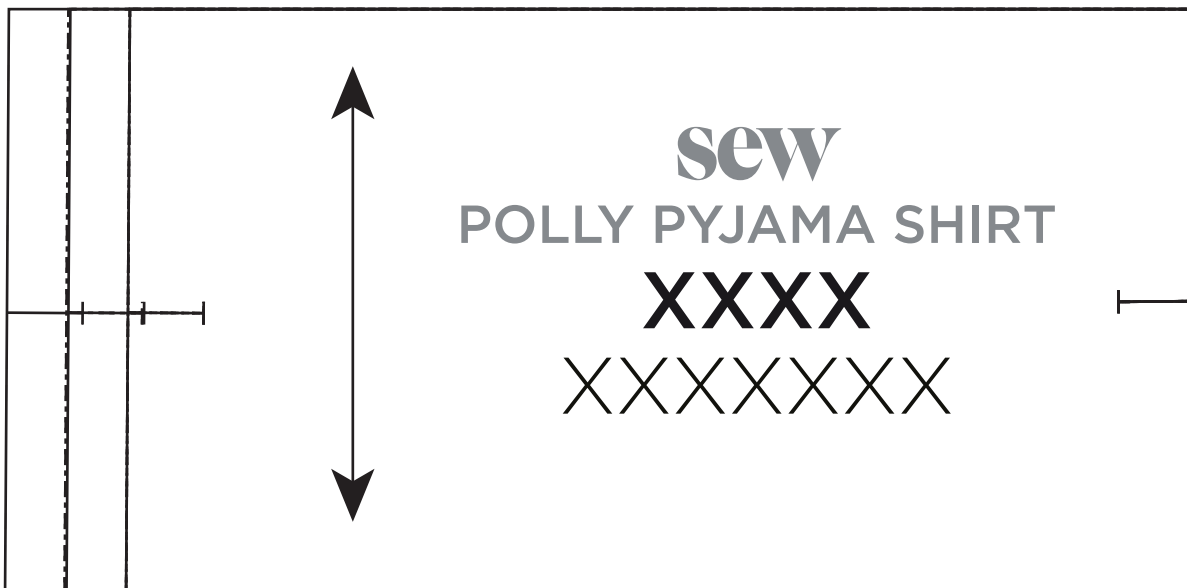
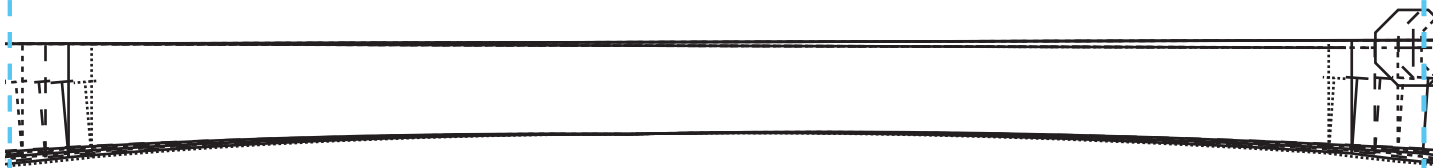

4

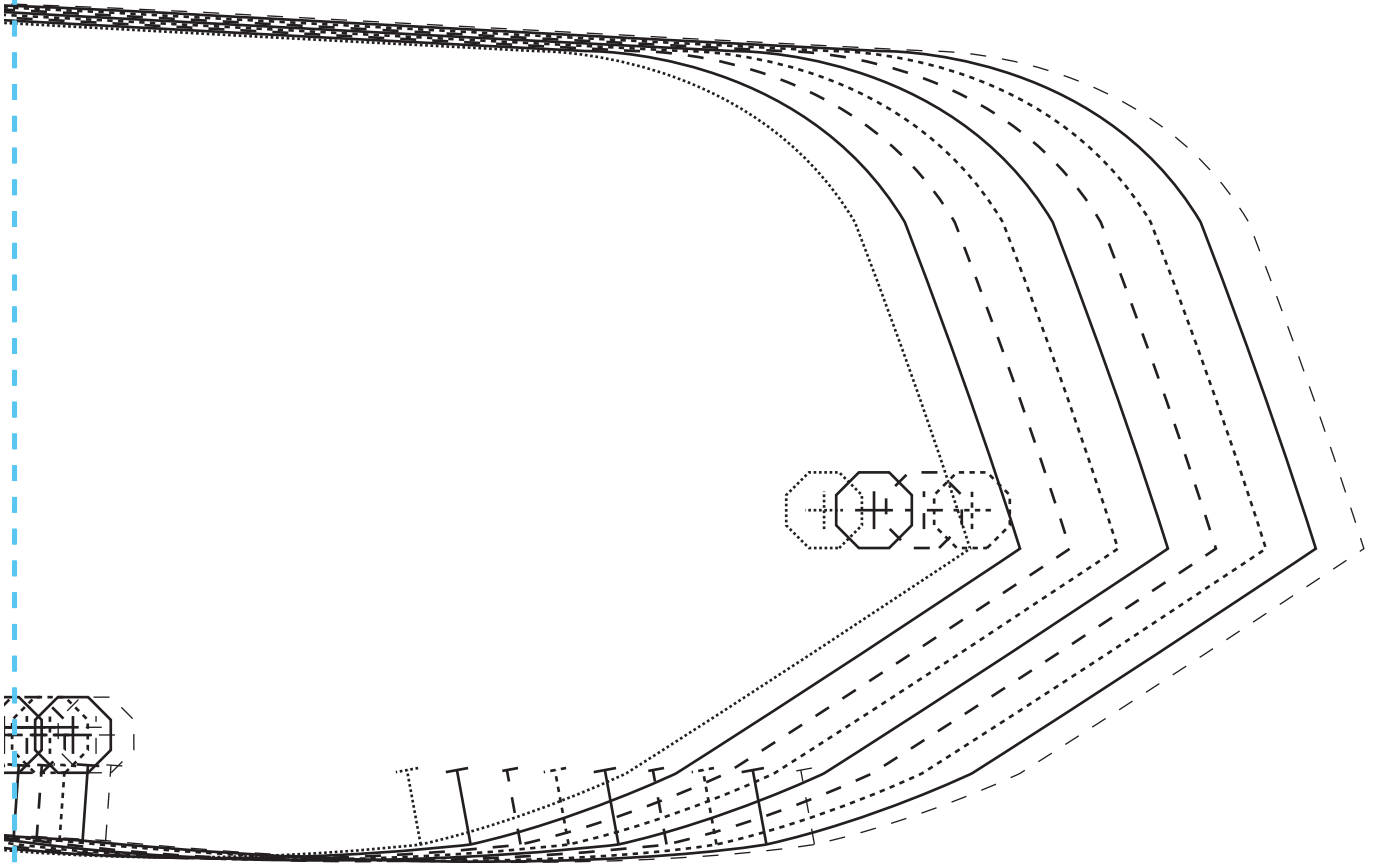

5

TEST SQUARE
10cm

6

- **Size 8**
- _____ **Size 10**
- - - - - **Size 12**
- **Size 14**
- _____ **Size 16**
- - - - - **Size 18**
- **Size 20**
- _____ **Size 22**
- - - - - **Size 24**

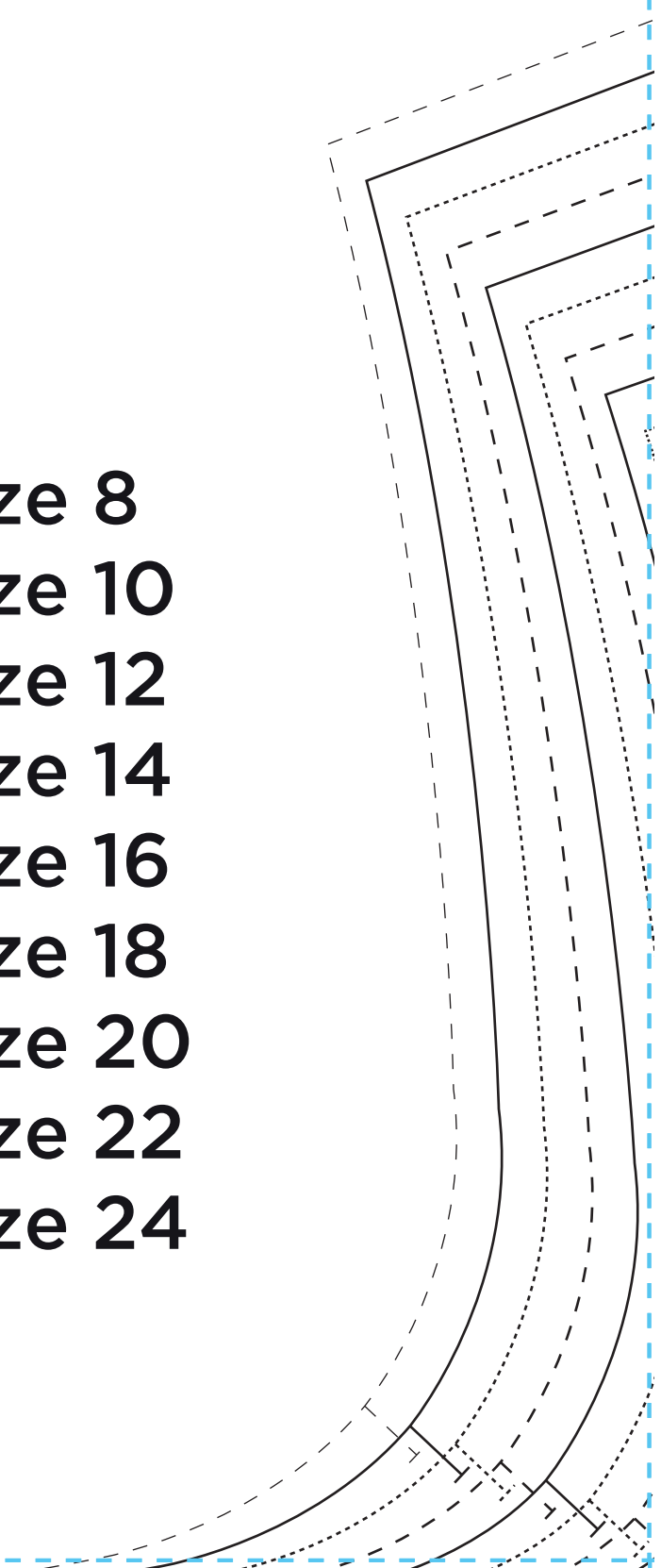

7

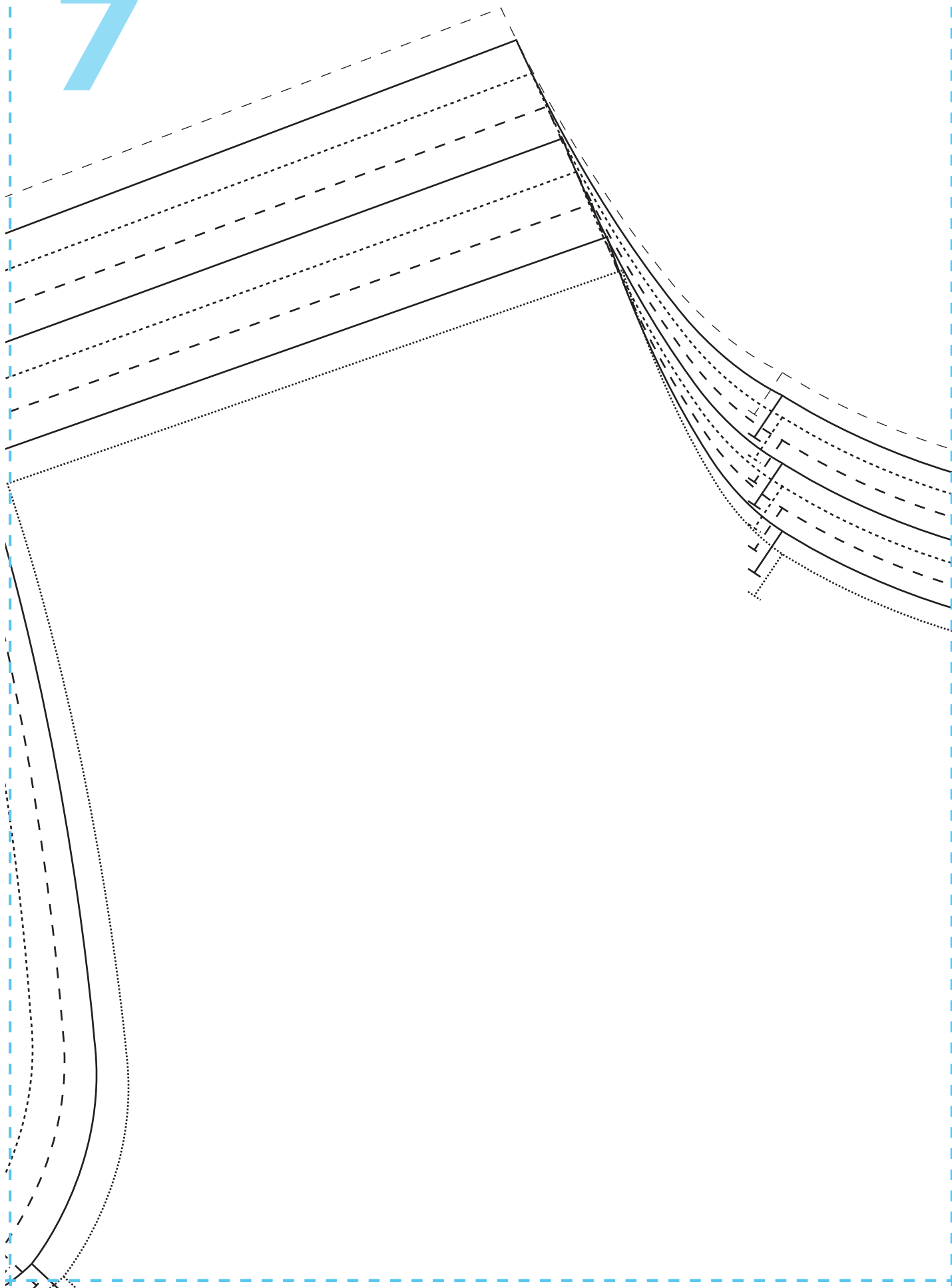

8

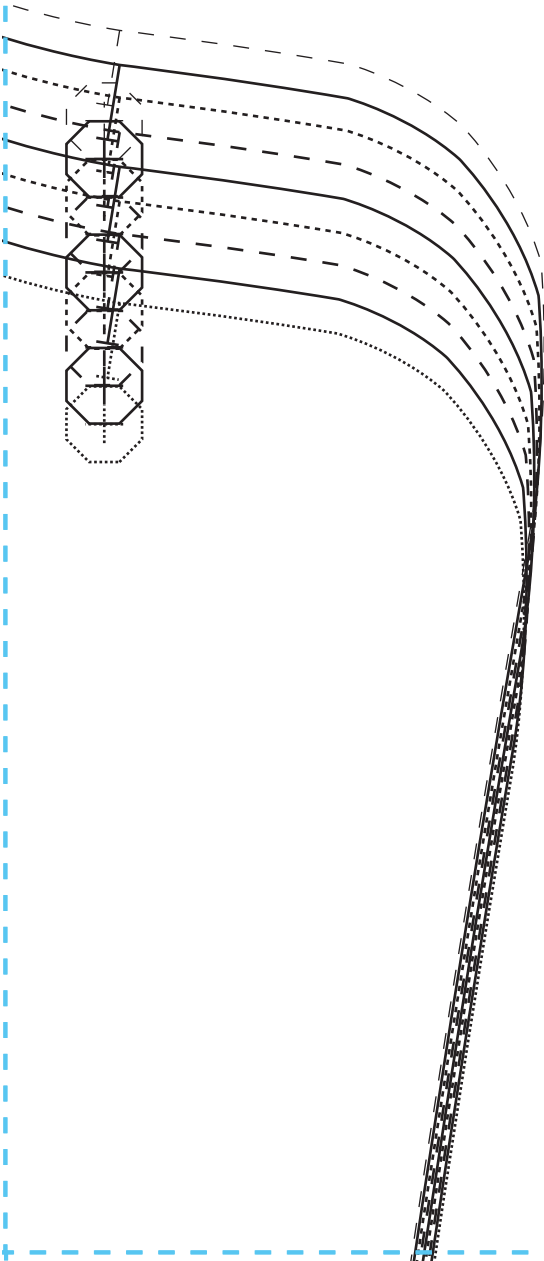

9

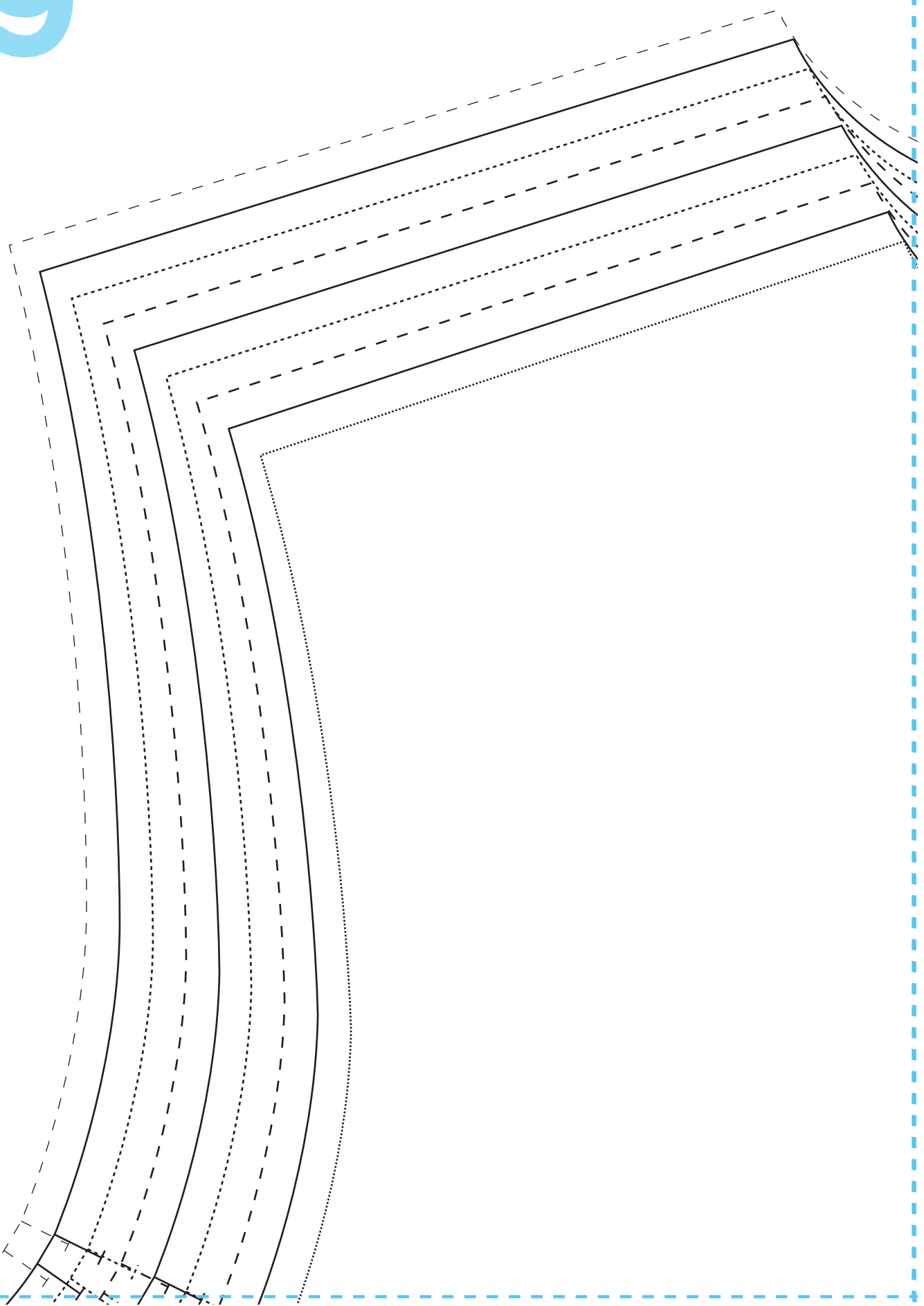

10

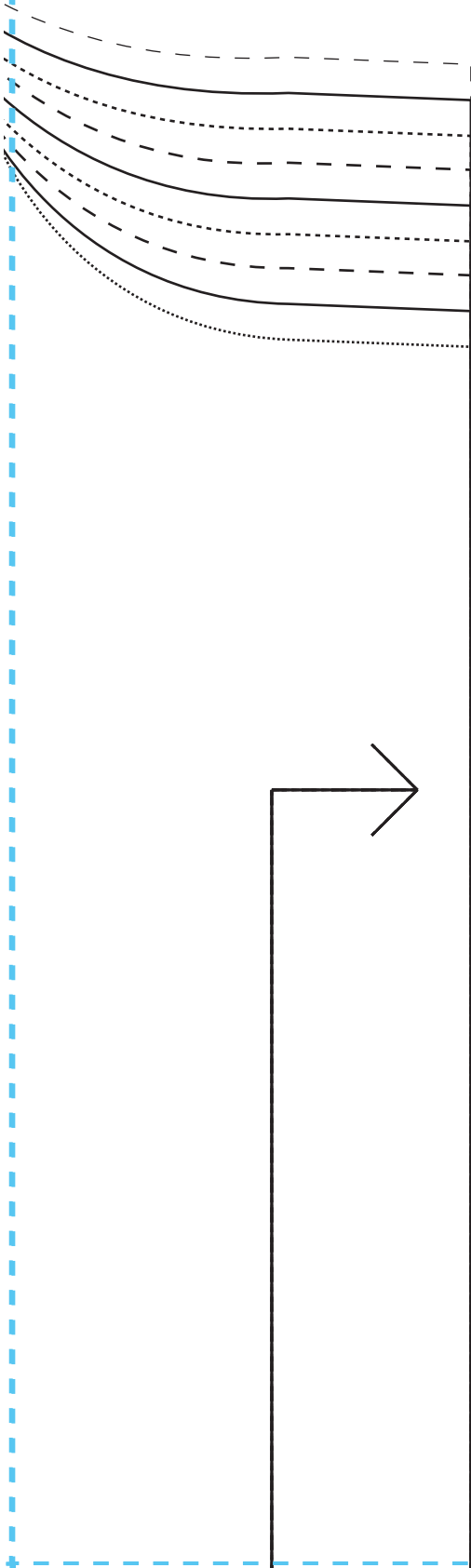

11

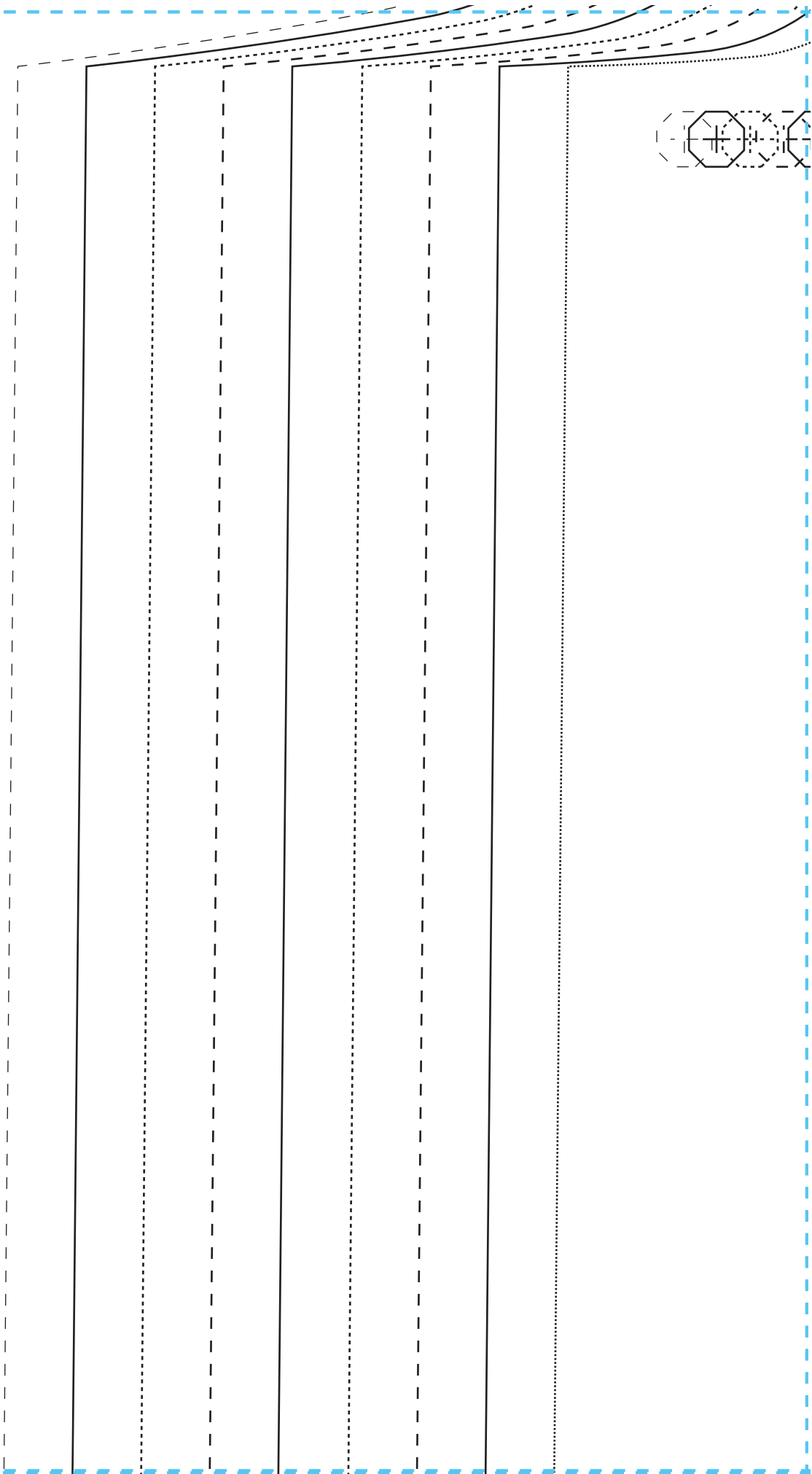

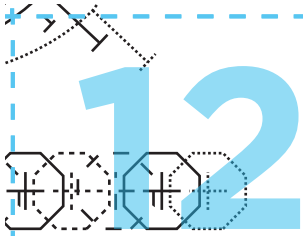

sew
POLLY PYJAMA SHIRT
XXXX
XXXXXXXXXX



13

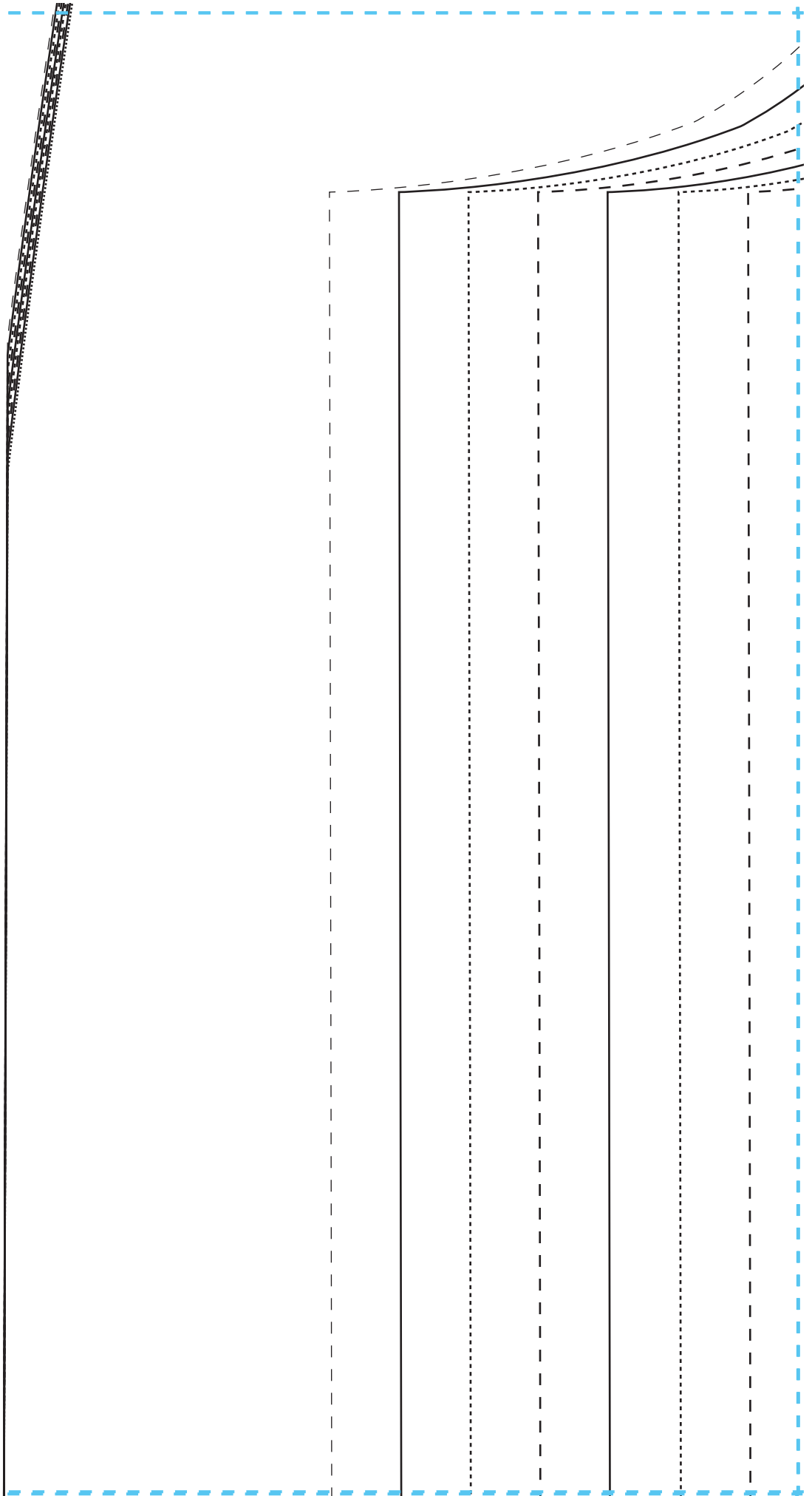

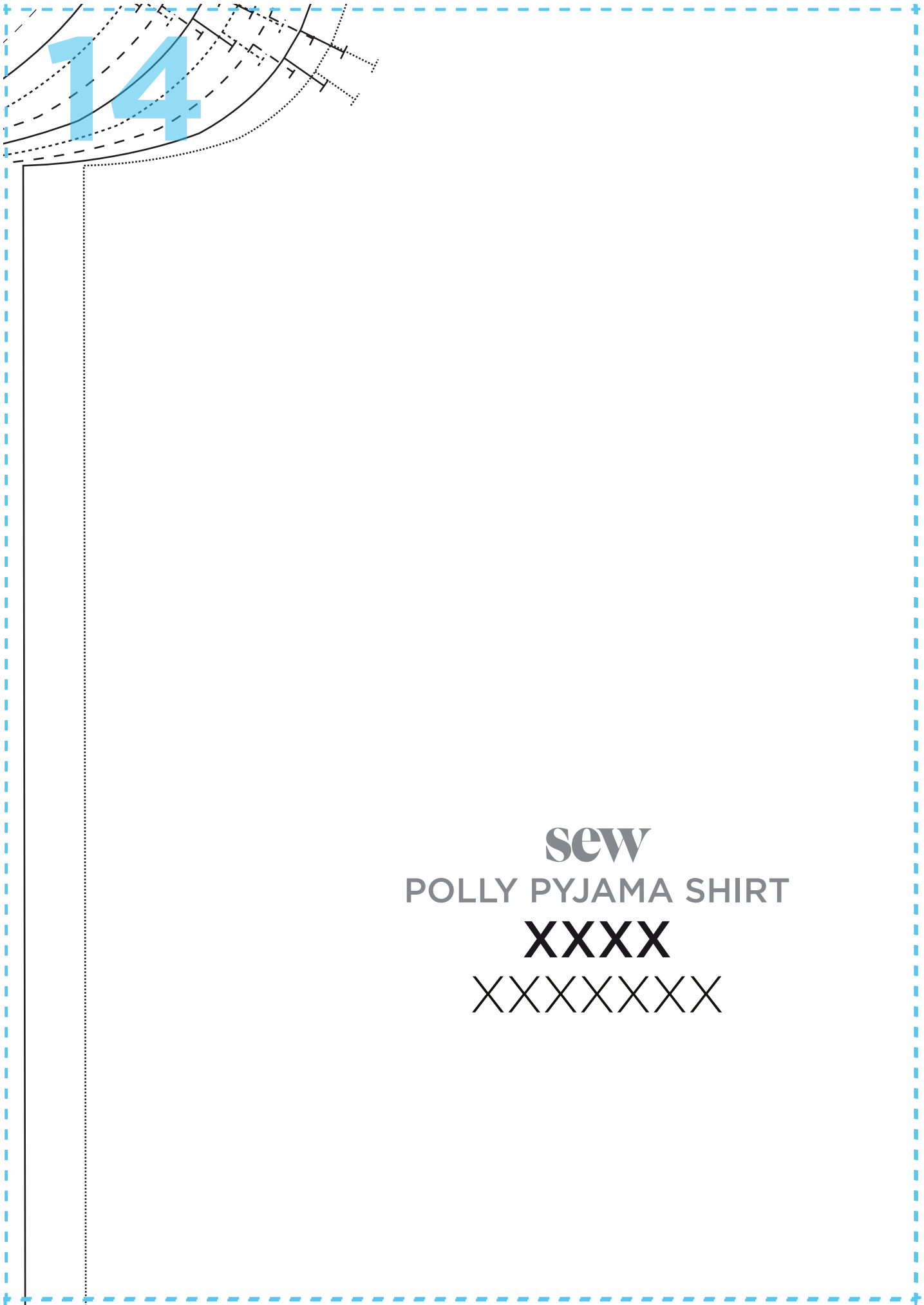

14

sew
POLLY PYJAMA SHIRT
XXXX
XXXXXXXXXX

15



16

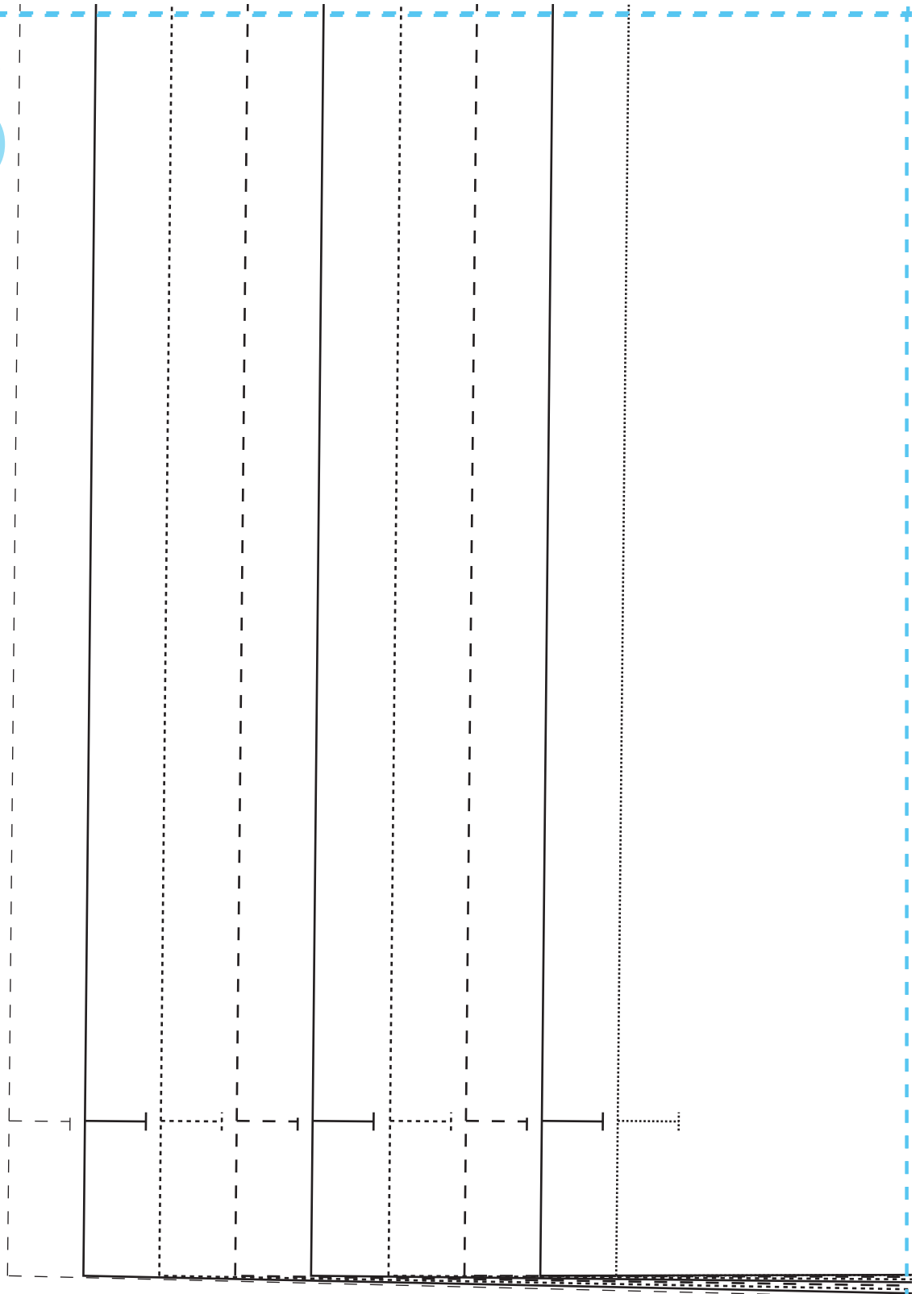

17



18

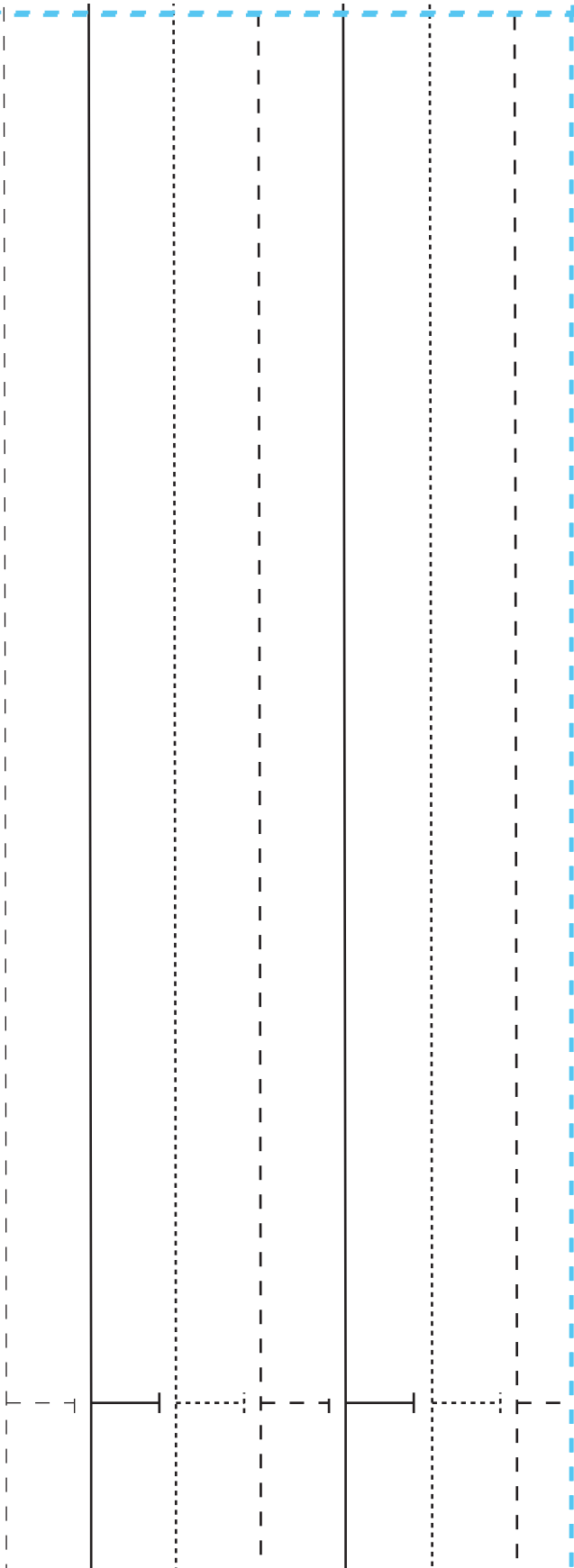
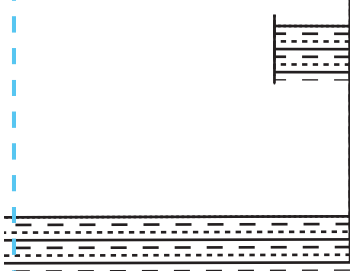

19

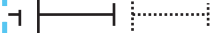

20



21

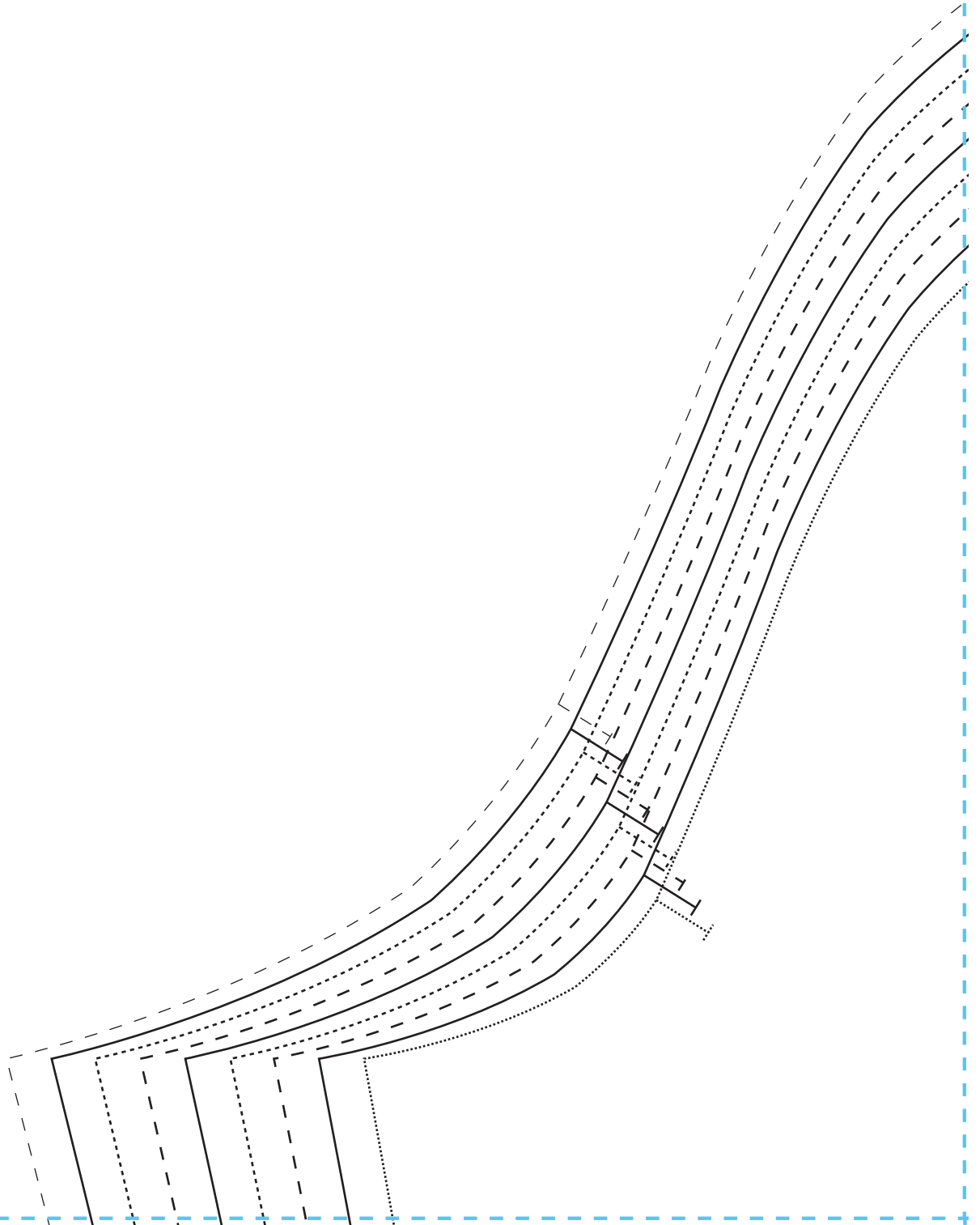

22

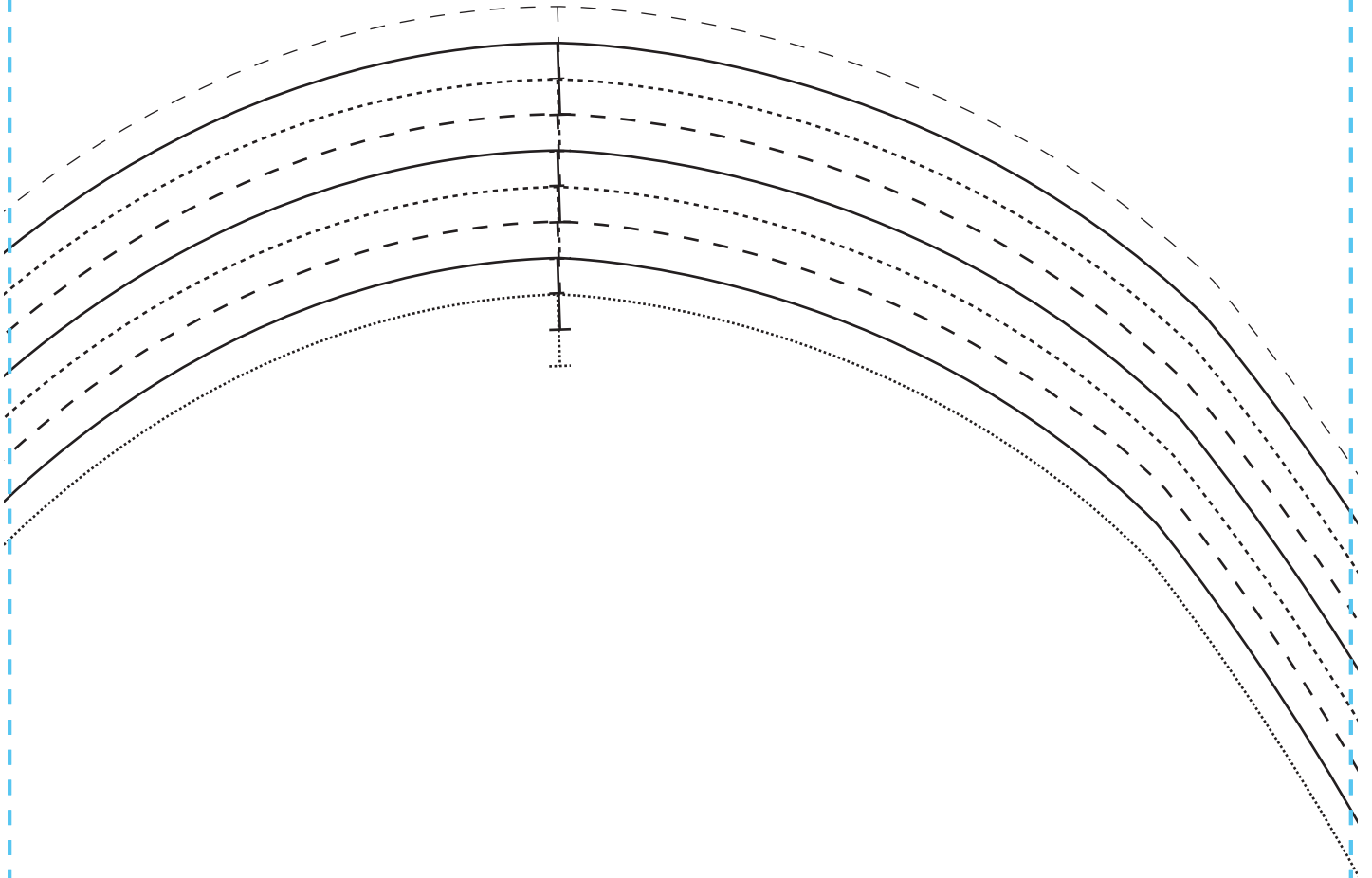

23

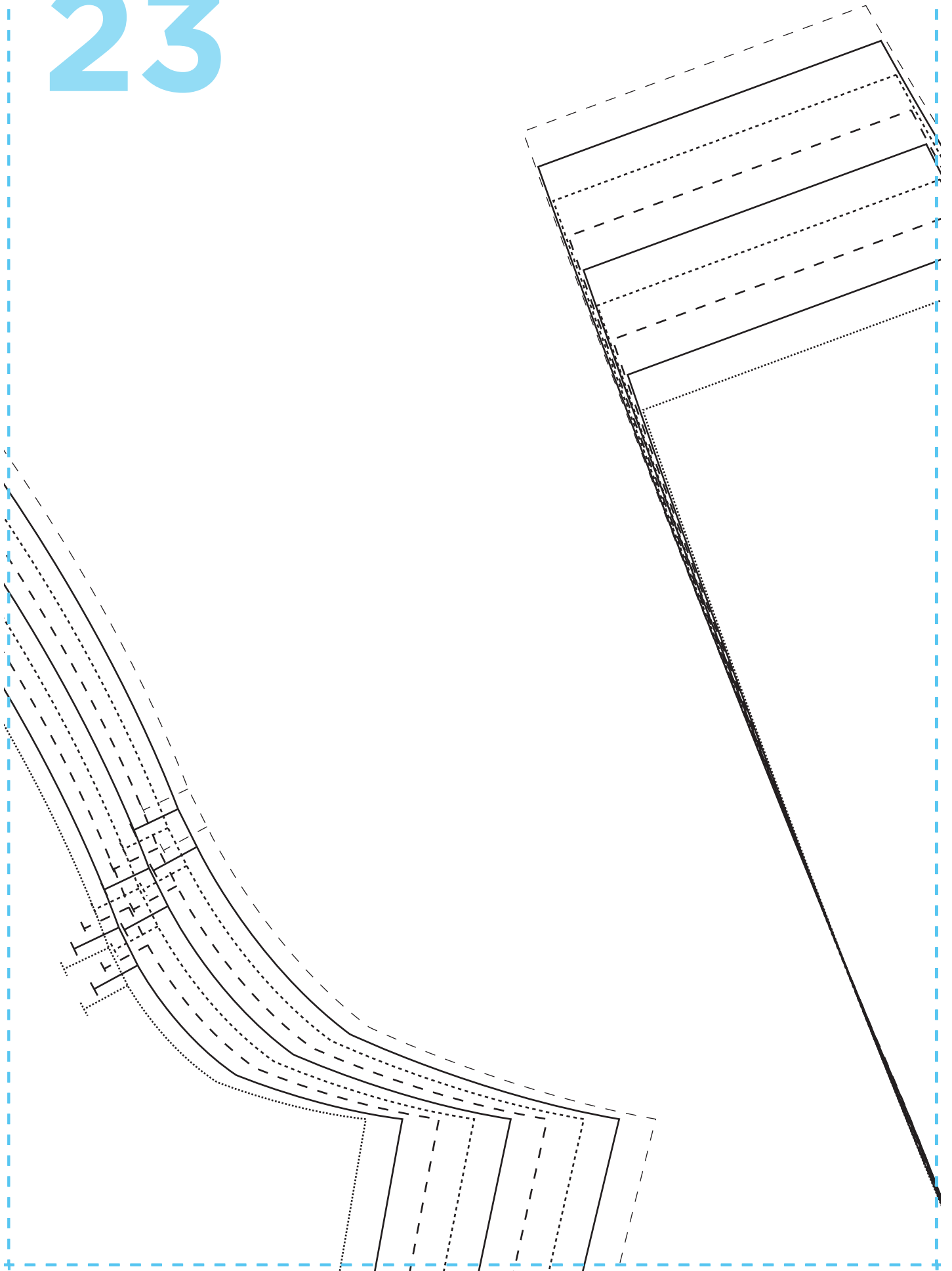

24

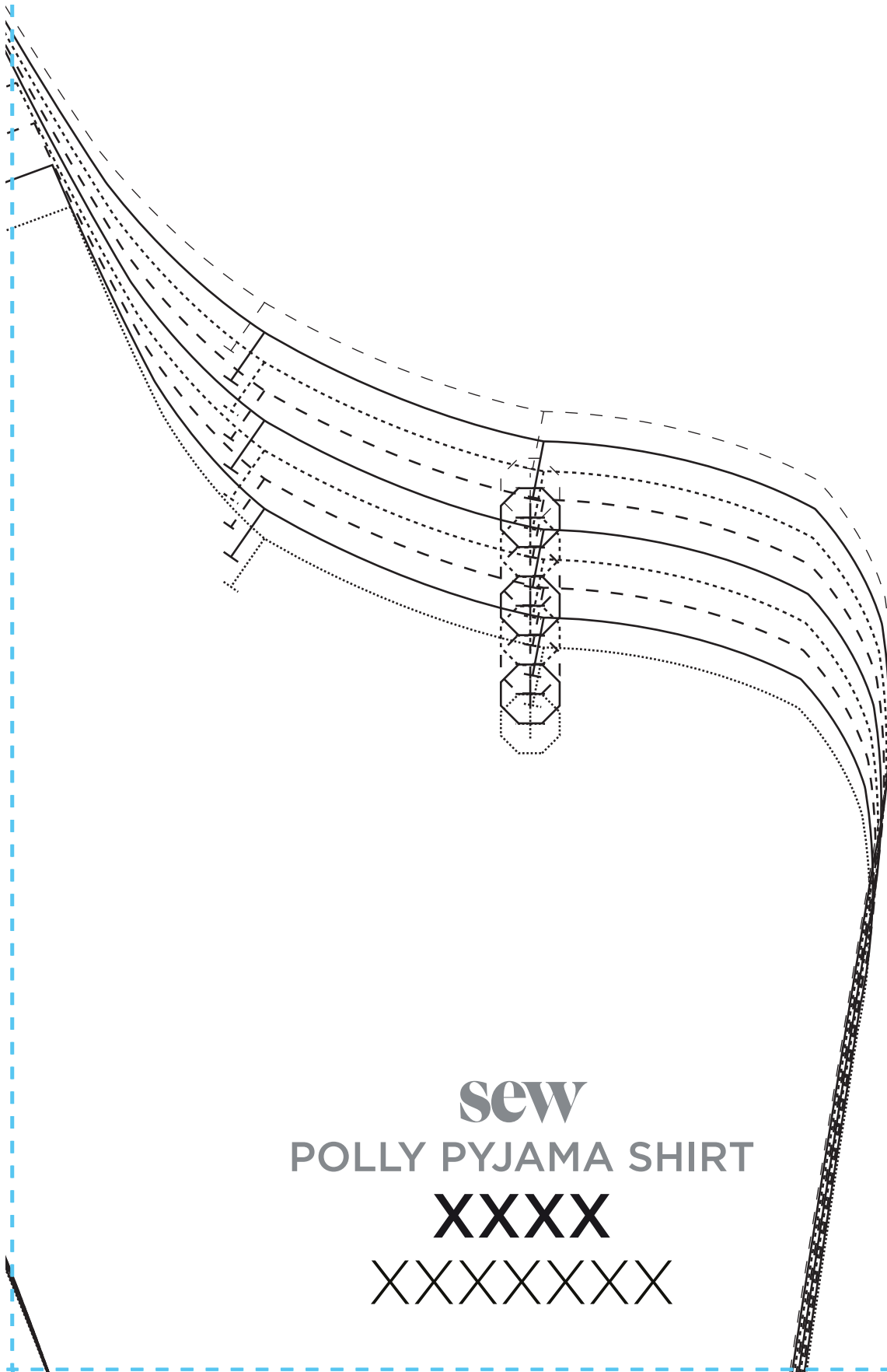

sew
POLLY PYJAMA SHIRT
XXXX
XXXXXXXXXX

25

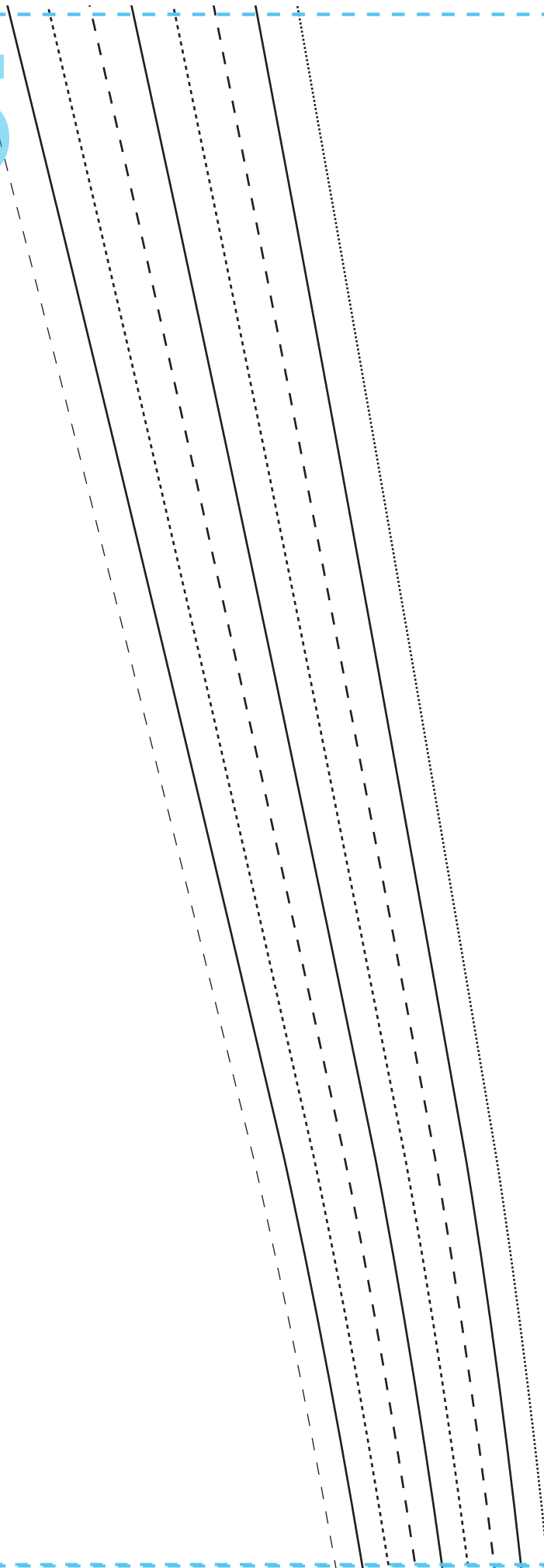

26

sew
POLLY PYJAMA SHIRT
XXXX
XXXXXXXXXX

27

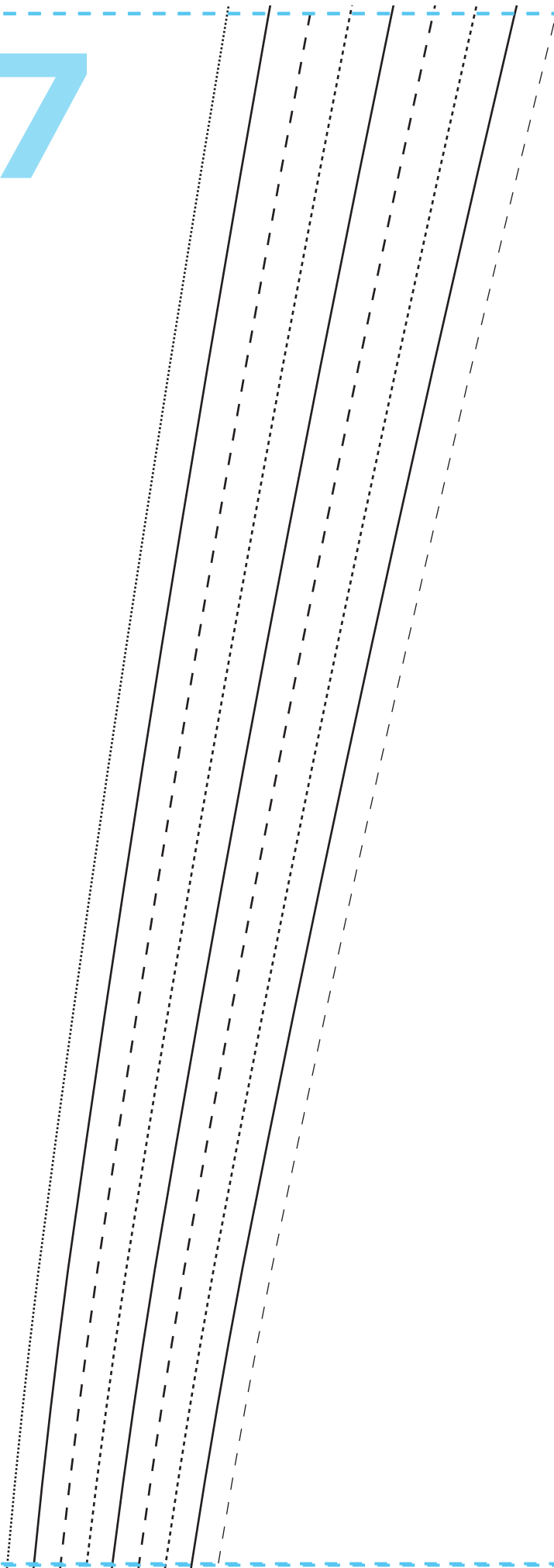

28

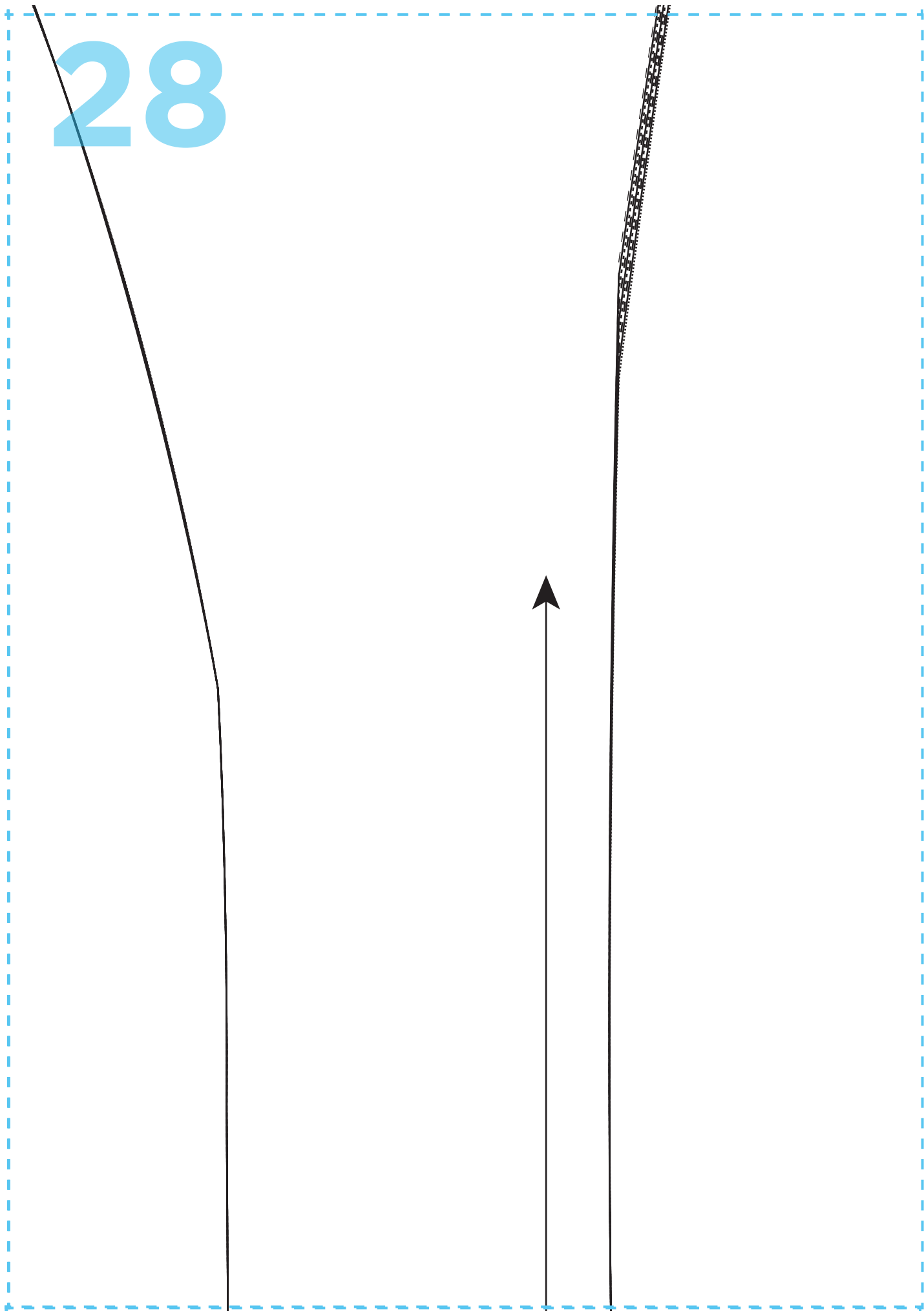

29

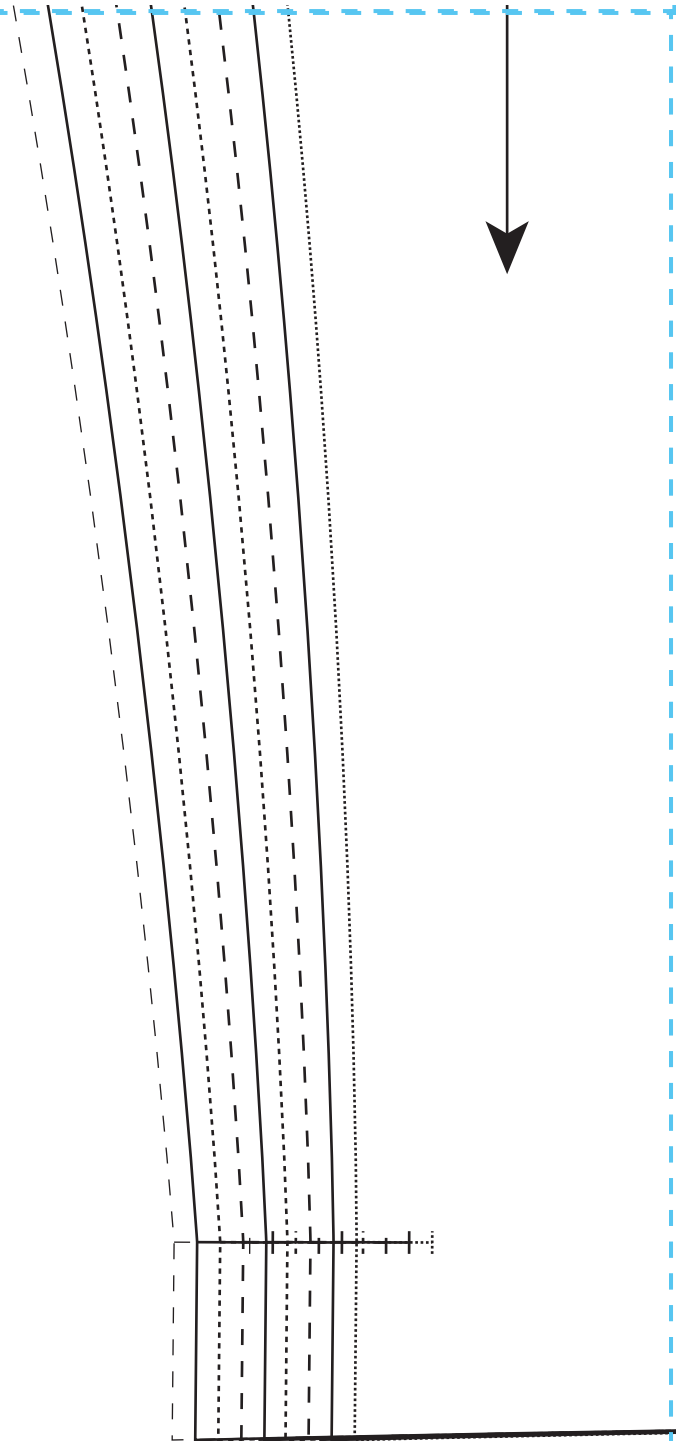

30

31

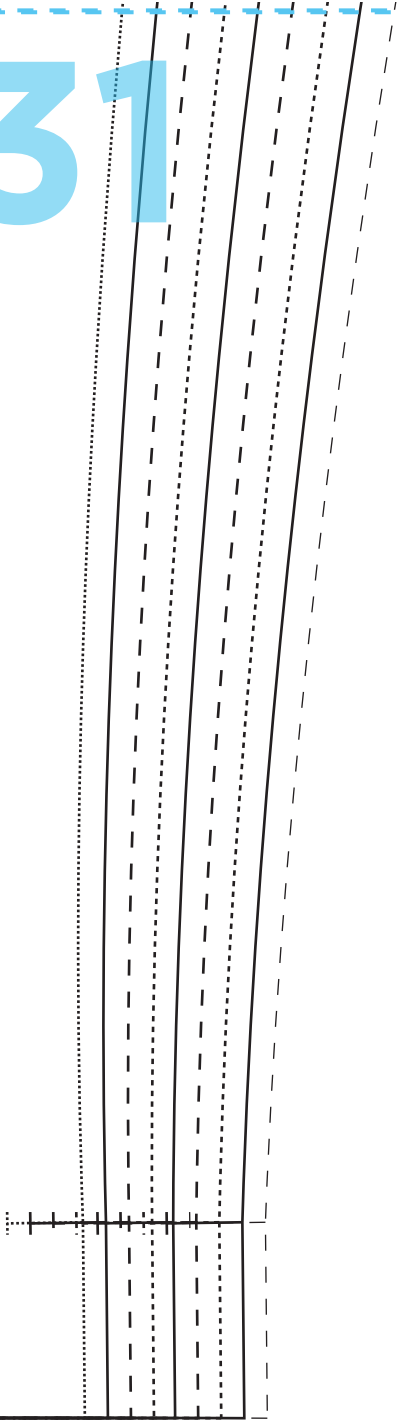

32

