

Размер 64
рост 191-197 см

Соответствие размеров
смотрите на сайте
«Шкатулка»
<https://shkatulka-sew.ru>

Файл с выкройкой и все его фрагменты охраняются
законом об авторском праве. Публикация и распространение
выкройки и ее фрагментов запрещены!

Официальное разрешение предоставлено только следующим
сайтам:

<http://materials.tell4all.ru>

Если Вы обнаружили нарушение авторских прав,
необходимо сообщить об этом по адресу admin@tell4all.ru

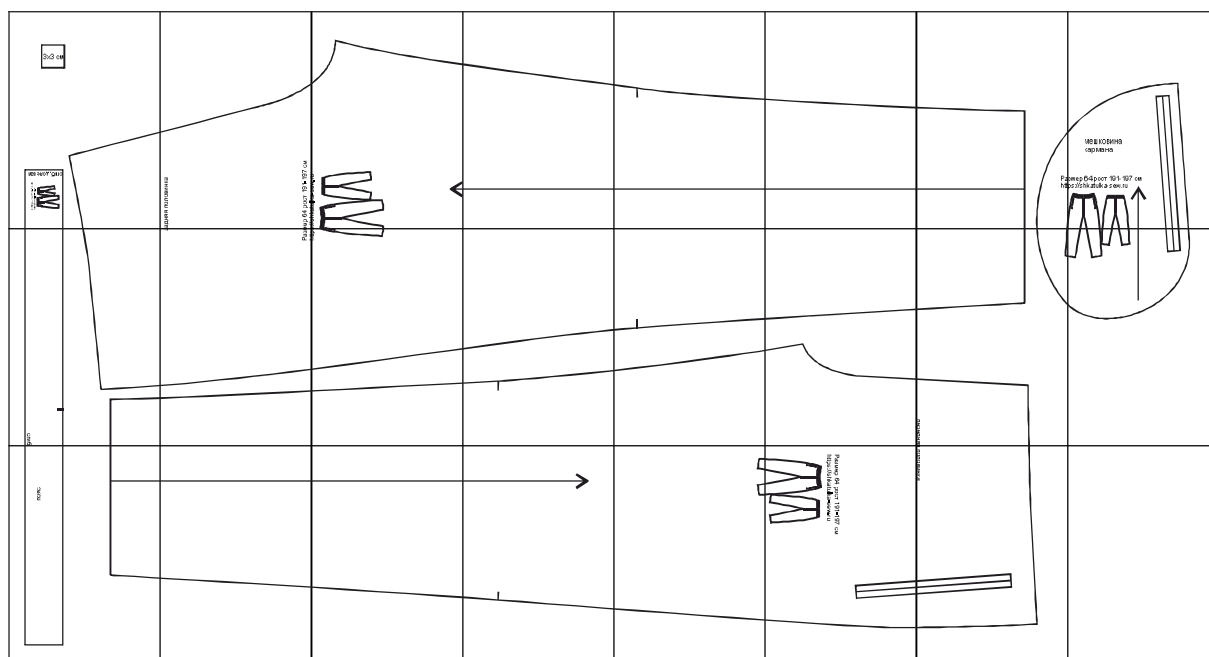

(1, 1)

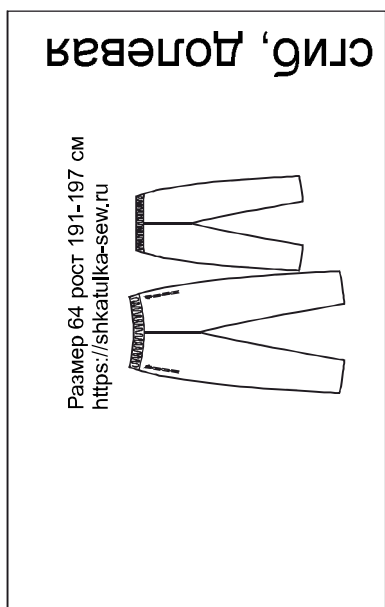
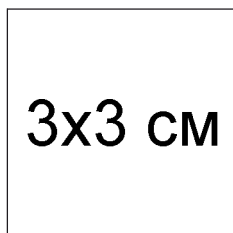

задняя половинка

(2, 1)

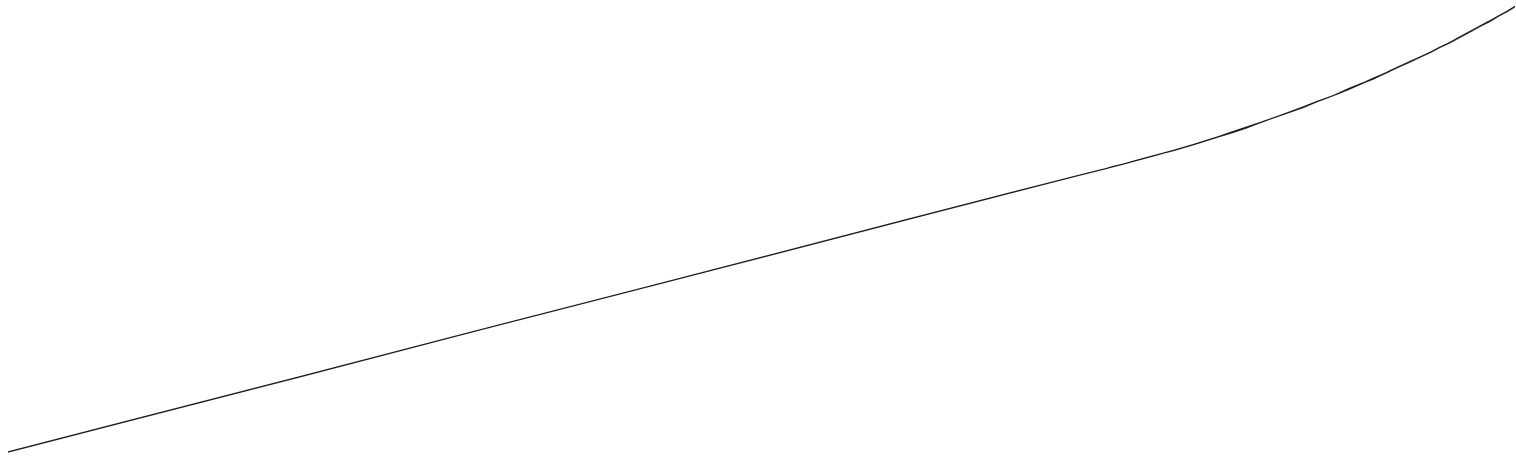

Мер 64 порт 191-197 см
s://shkatulka-sew.ru

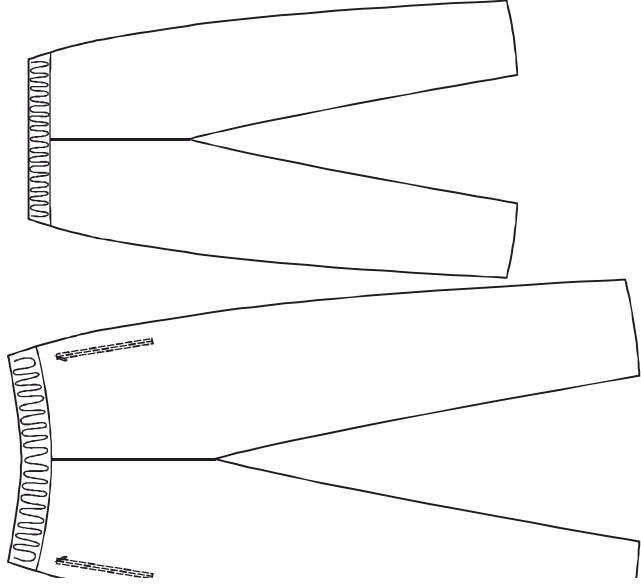

(3, 1)

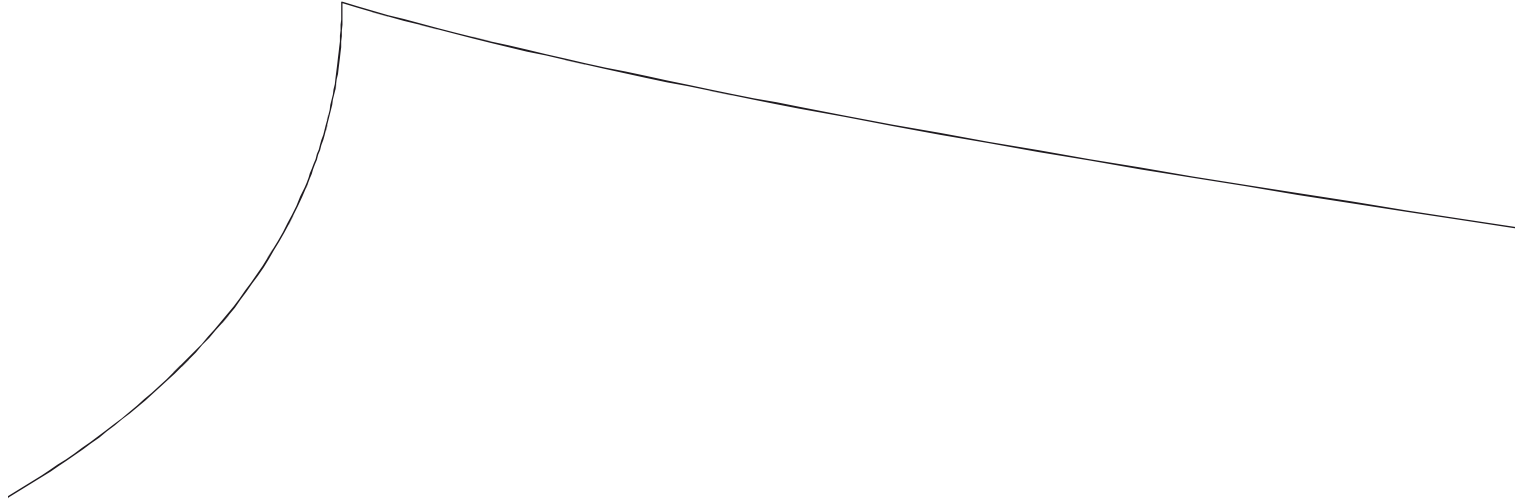

(4, 1)

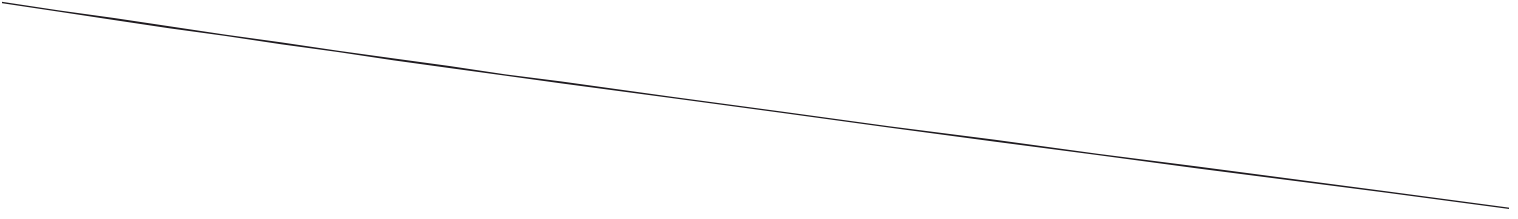

(5, 1)

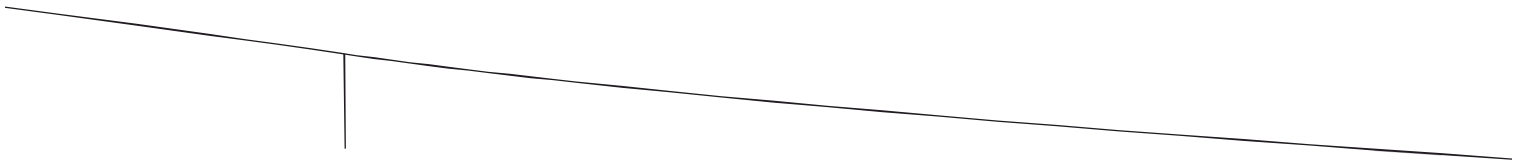

(6, 1)



⊥ (7, 1)

⊥

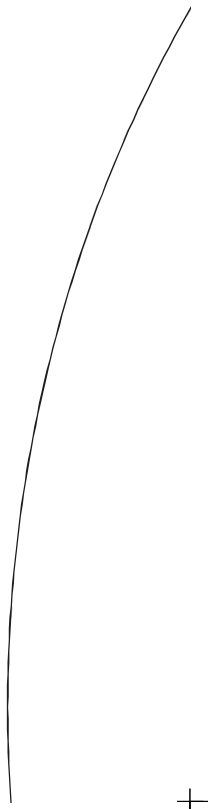
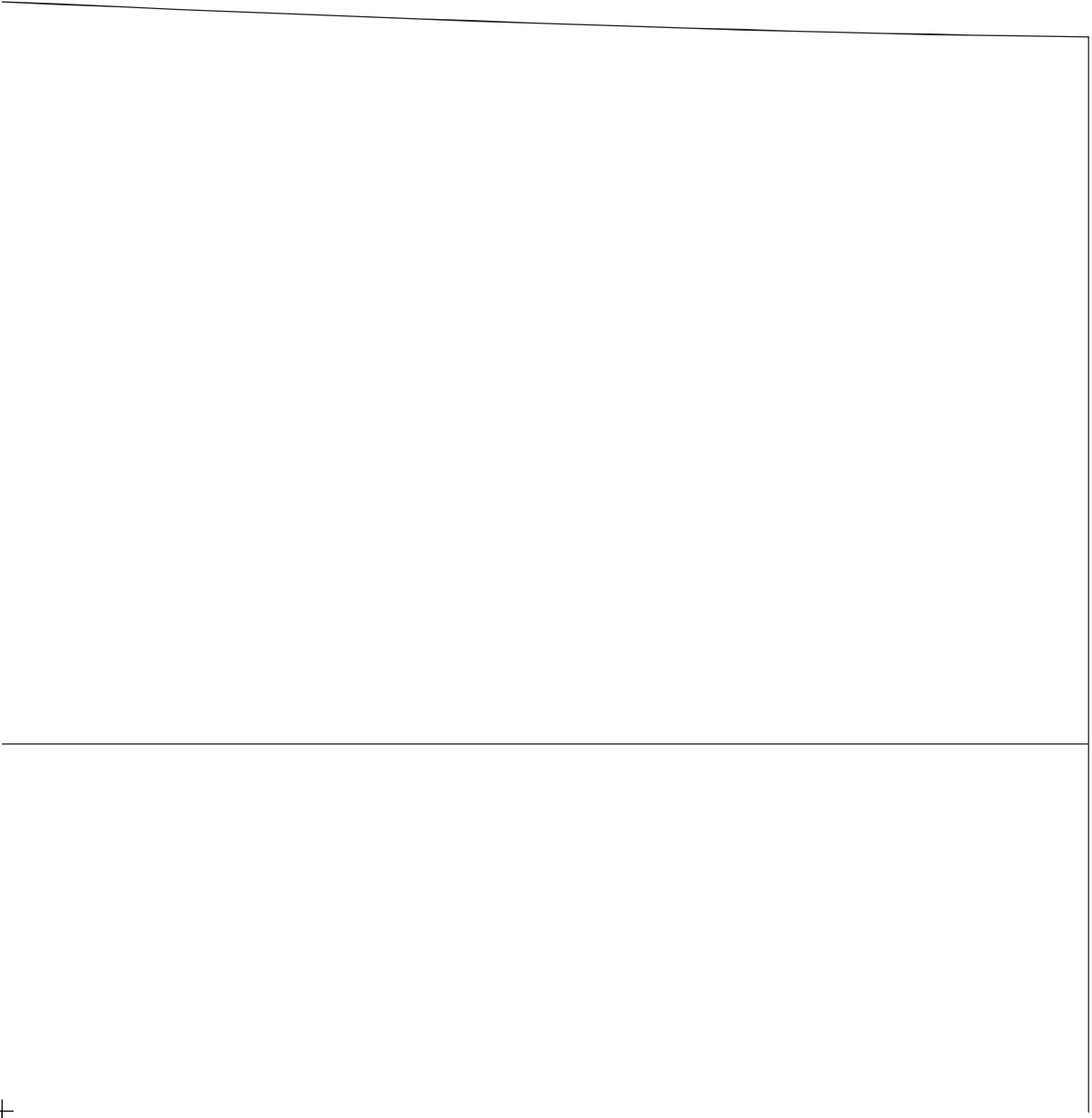

+

+

**МЕШКОВИНА
кармана**

Размер 64 рост 191-197 см
<https://shkatulka-sew.ru>

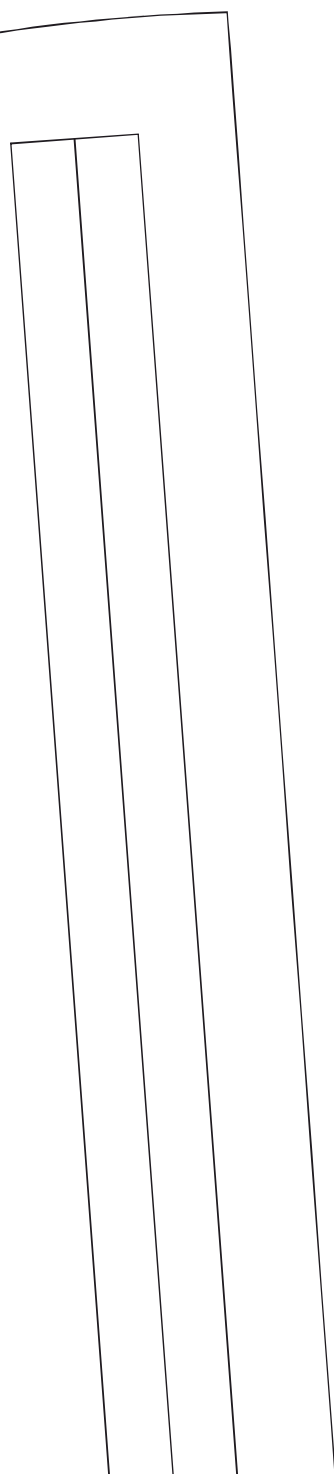
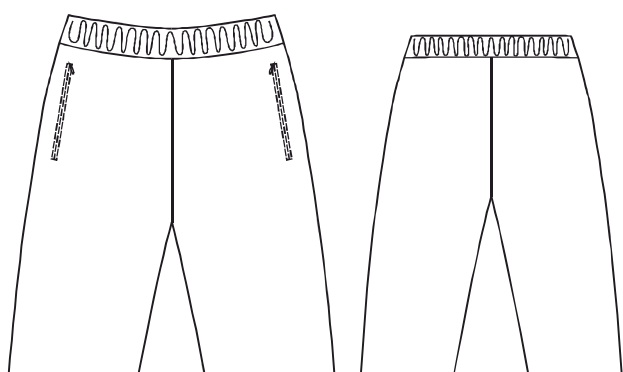

СТНБ

(1, 2)

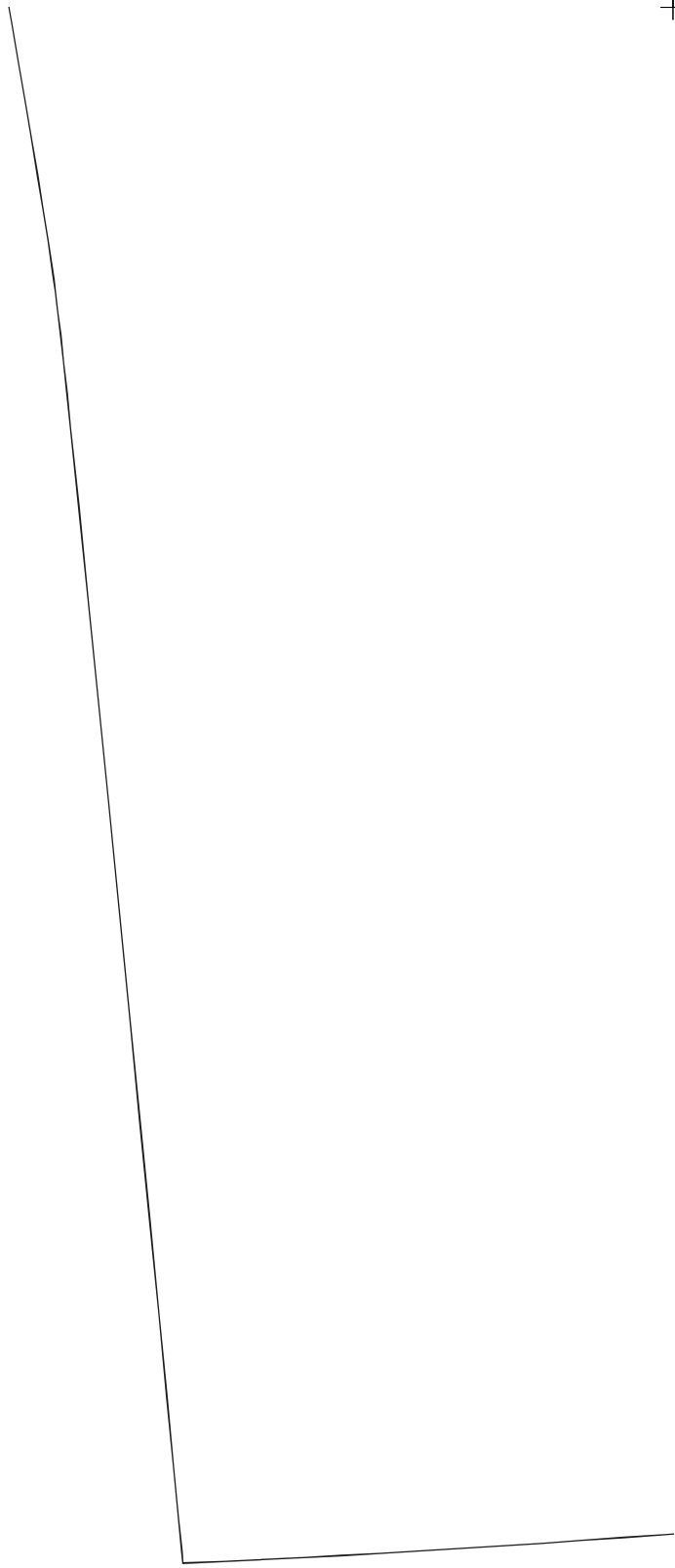



(2, 2)

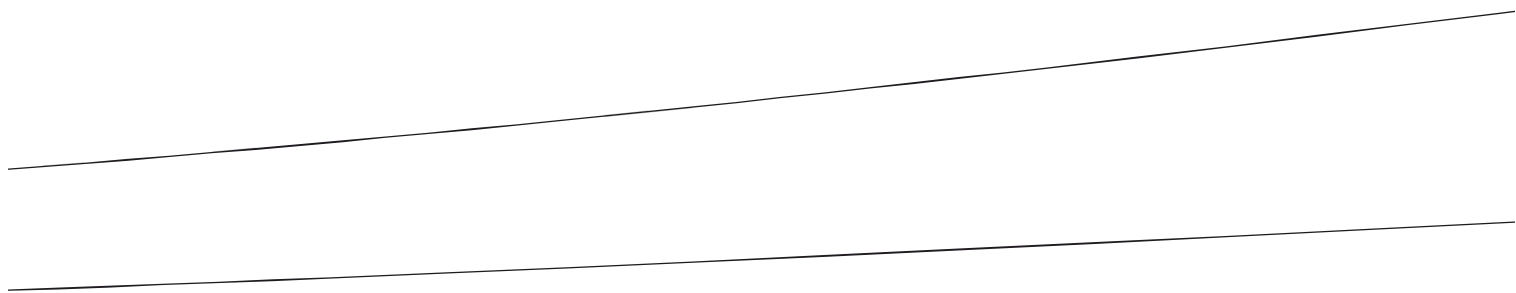

Pa31^(3, 2)
http:

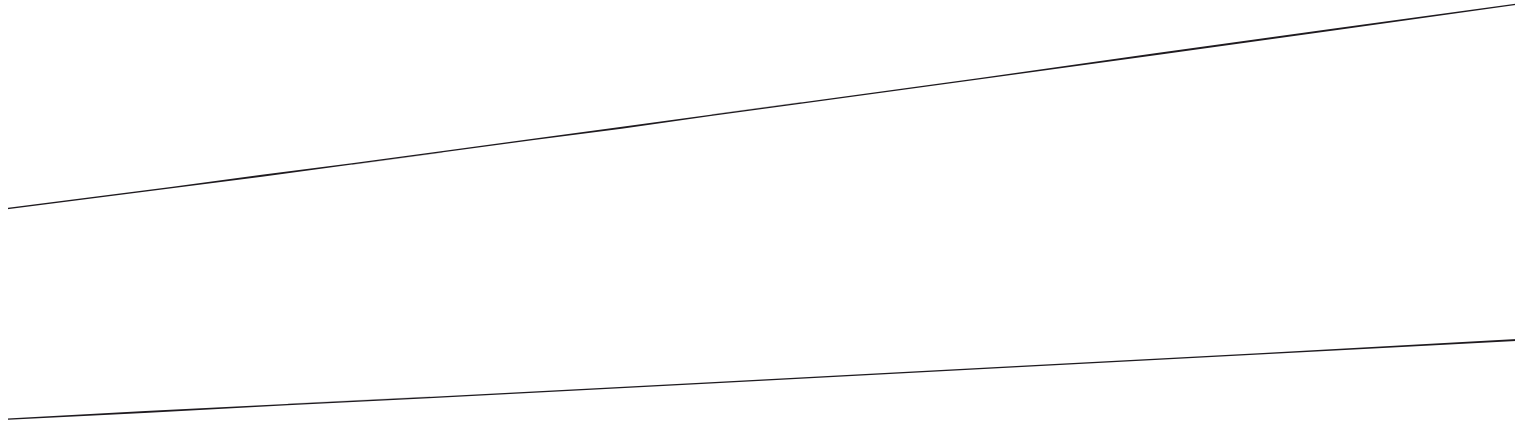

(4, 2)

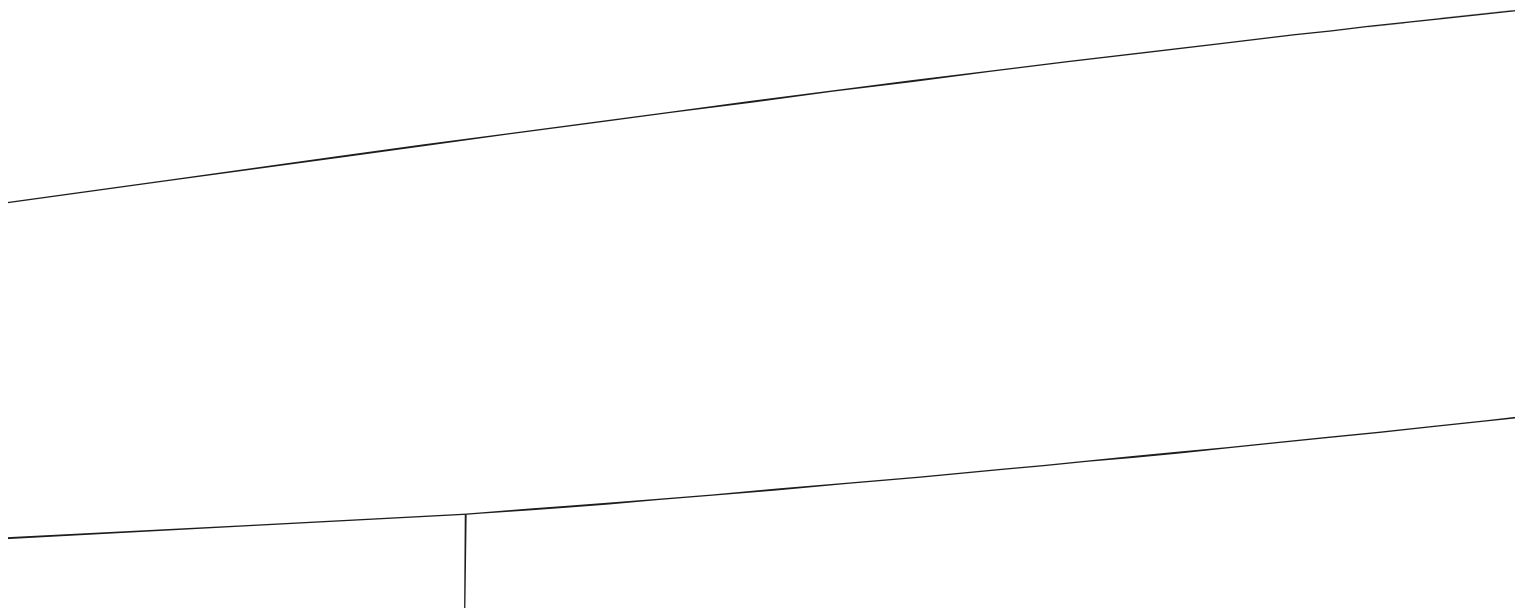

(5, 2)

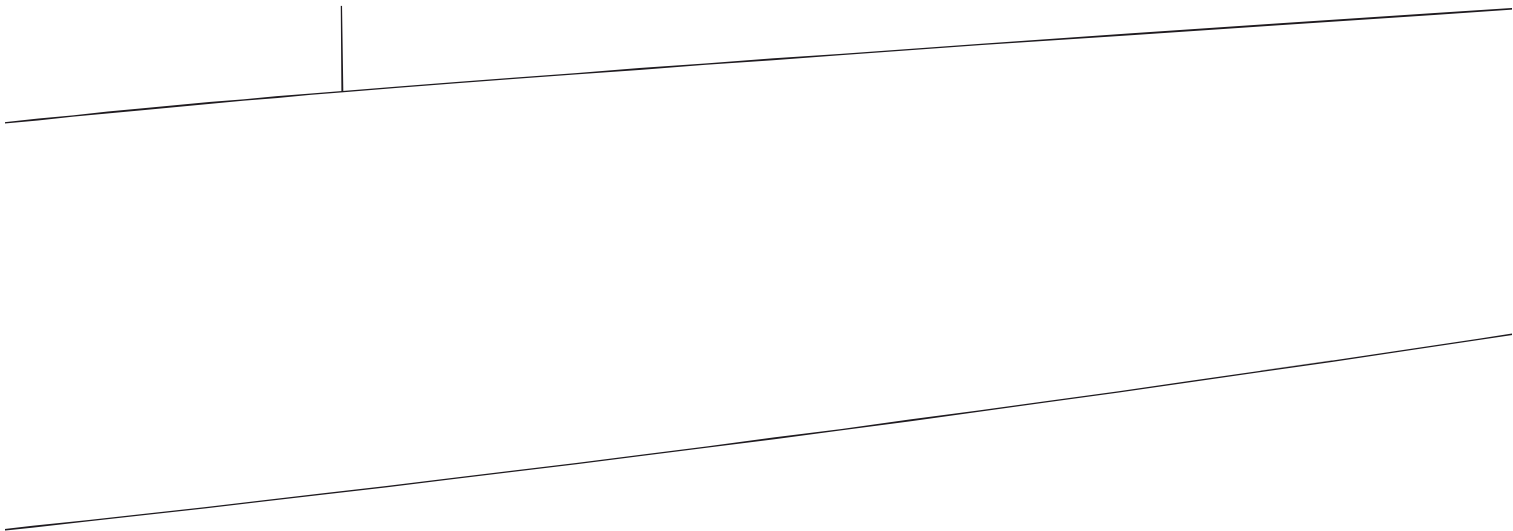

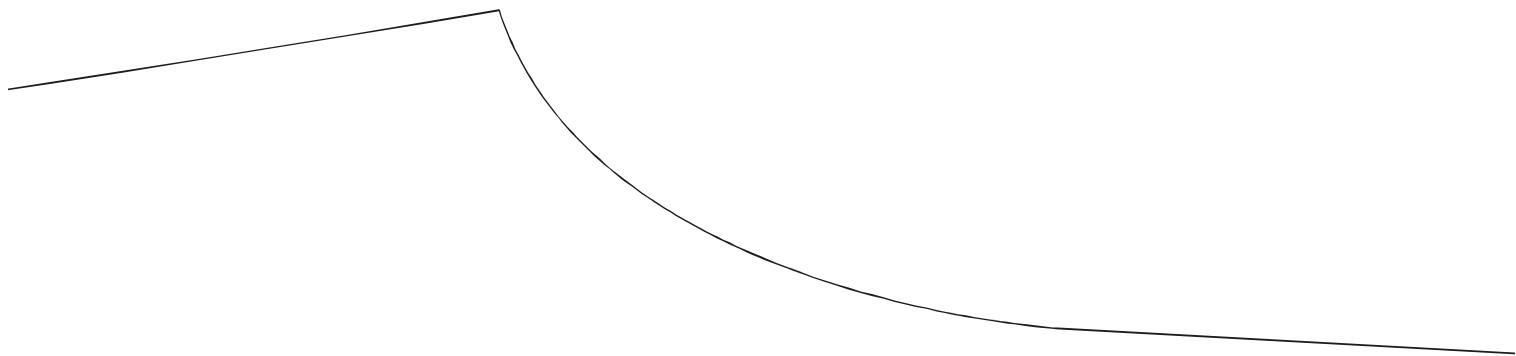

(7, 2)

передняя



(8, 2)

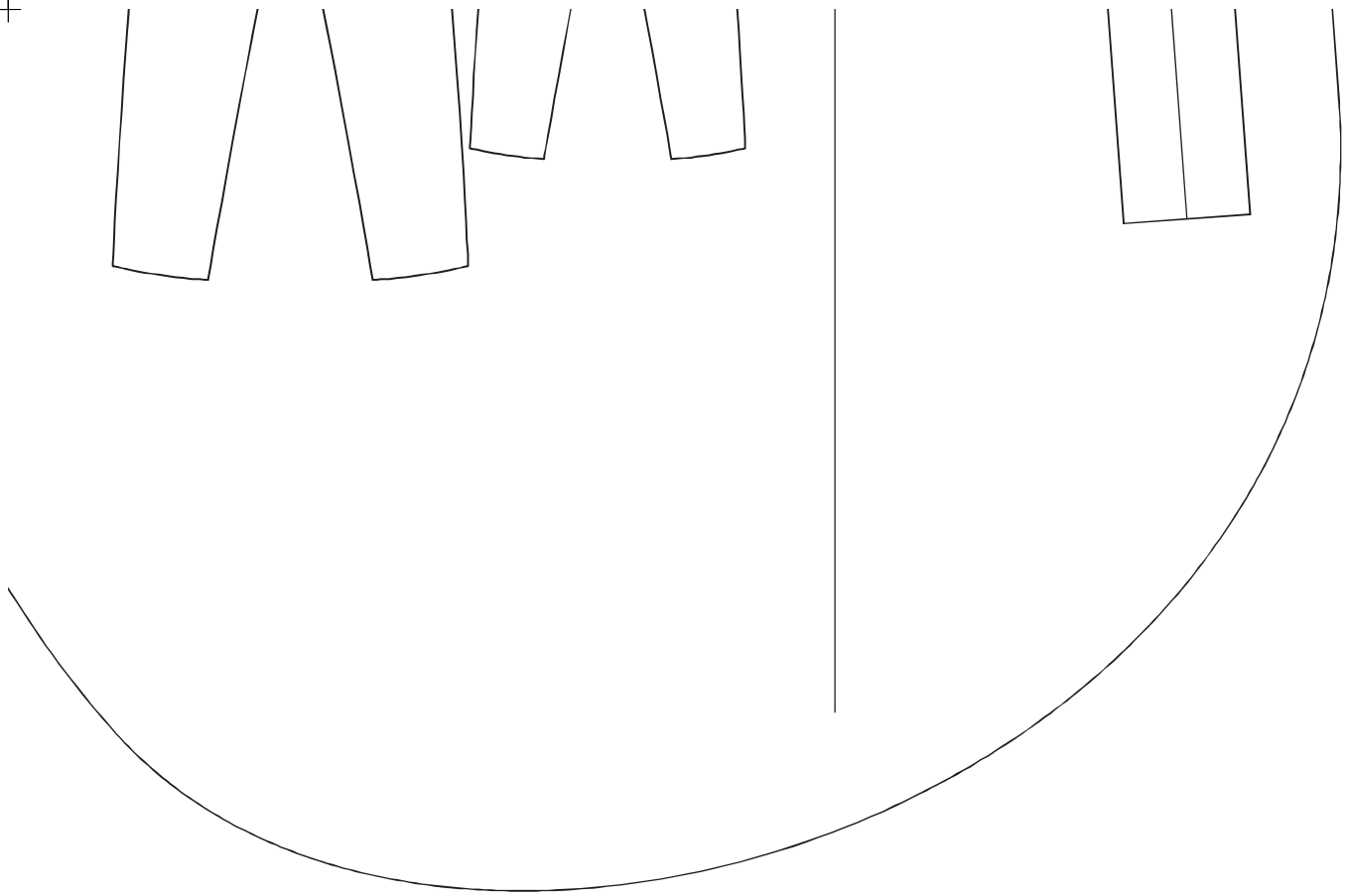

ПРОЦ



(3, 3)



(4, 3)



(4, 3)

(5, 3)

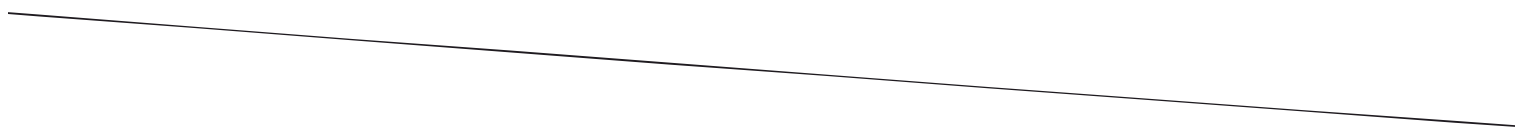

Размер 64 поСТ 191-197 см
<https://shkatulka-sew.ru>

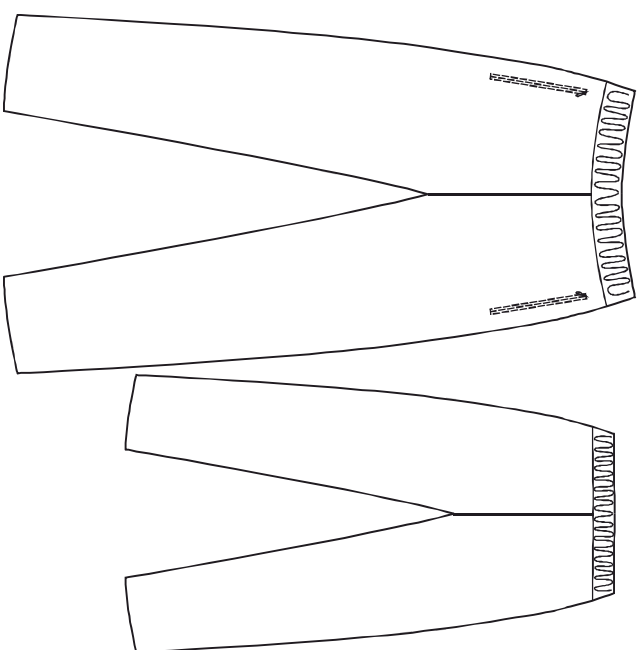

І ПОЛОВИНКА

