



SUMMER 2013

ariel women's *swimsuits*

PATTERN

by LAURA KEITH

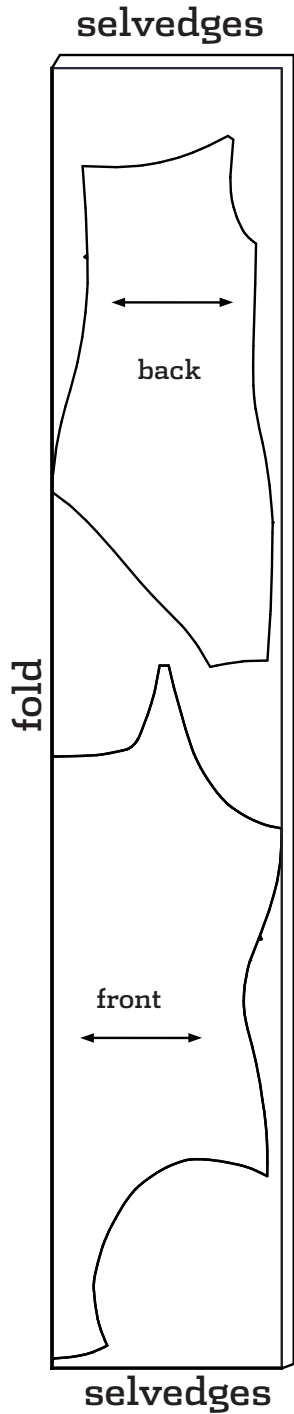
Project photo on page **73**; instructions on page **131** of *Stitch* Summer 2013.

For the home sewist who wants to spend more time in the pool and less time trying on swimsuits, both the one-piece and the bikini version will make for a delightfully figure-flattering summer.

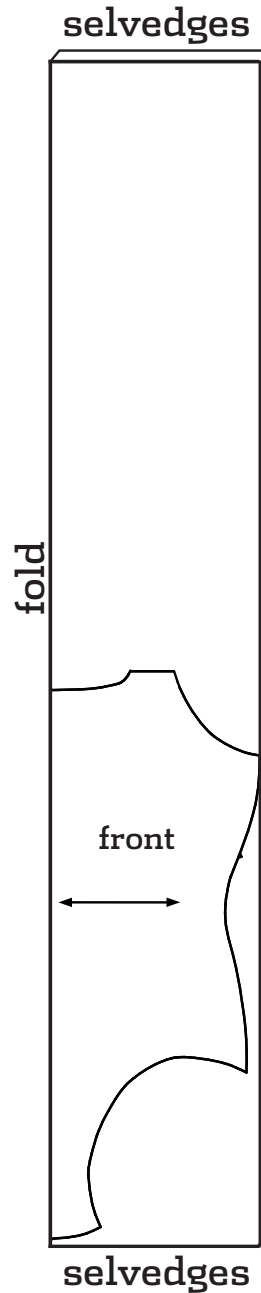


PHOTO BY LARRY STEIN

one-piece
54-60"
main
XS, S, M, L, XL

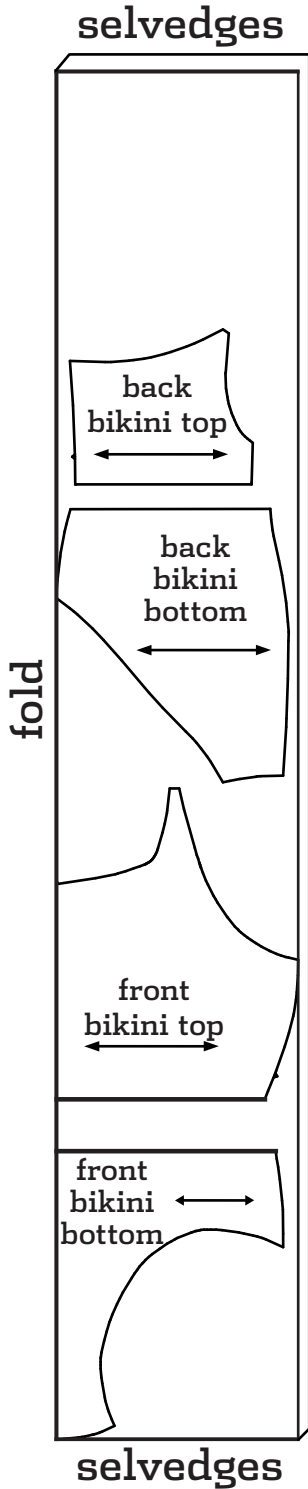


one-piece
54-58"
lining
XS, S, M, L, XL



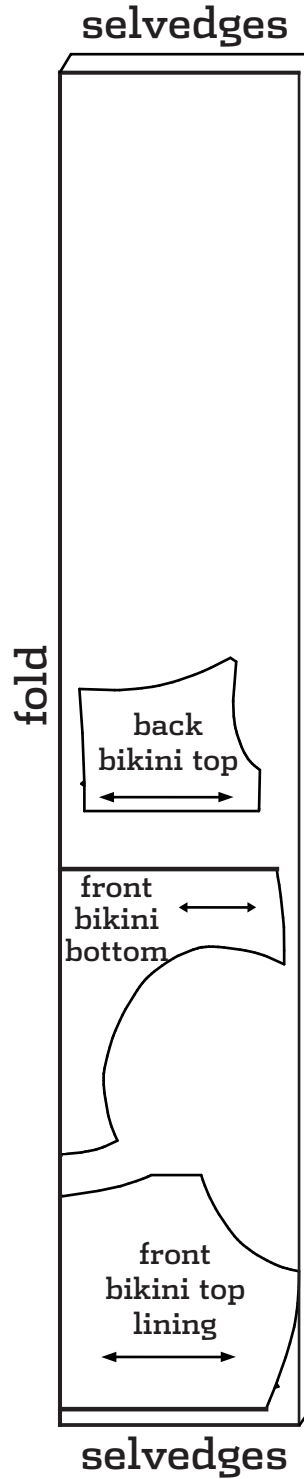
bikini
54-58"

main
XS, S, M, L, XL



bikini
54-58"

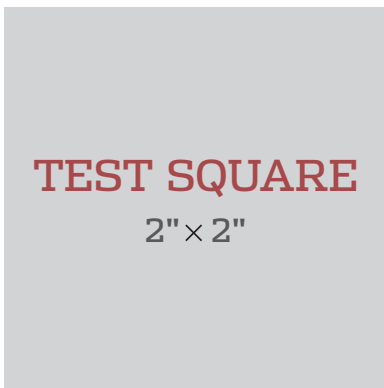
lining
XS, S, M, L, XL



GETTING STARTED BASIC TECHNIQUES AND TERMS YOU'LL NEED TO KNOW FOR THE PATTERN YOU HAVE DOWNLOADED.

ASSEMBLING FULL-SIZE PATTERN PRINTOUT

1 | When preparing to print the PDF, make sure that you are printing it at 100% and that there is no scaling. Check the settings for page scaling (should be "None") and check the preview to make sure that you will be printing at full size. Make sure that the box labeled "Auto-Rotate and Center" is unchecked



(instructions apply specifically to Adobe Reader; if using another PDF reader, check for similar settings).

2 | To ensure that the pattern has printed at the correct scale, check the size of the TEST SQUARE. The Test Square should be 2" x 2".

3 | To begin assembling the pattern, cut off or fold the dotted margin around each page.

4 | The pages are numbered in rows, so the first row of pages is numbered 1a, 1b, 1c, etc. Line up the rows and match the dotted lines together so they overlap. Tape the pages together. Use the illustrated guide to match each piece. Once the pattern is complete, find your size, pin the pattern to the fabric, and follow the coordinating line to cut out or trace the pattern.

LAYOUT, MARKING + CUTTING GUIDELINES

1 | Find the lines that correspond to your size and trace the pattern pieces, either on tissue paper or directly onto the fabric, using tracing paper and a tracing wheel.

2 | If you are cutting pattern pieces on the fold or cutting two of the same pattern piece, fold the fabric in half, selvedge to selvedge, with right sides together. Note that this technique is not appropriate for some fabrics so check the project instructions if you are unsure.

3 | Lay the pattern pieces on the fabric as close together as possible. Double-check that all pattern pieces to be cut "on the fold" are placed on the fold.

4 | Make sure all pattern pieces are placed on the fabric with the grainline running parallel to the lengthwise grain unless a crosswise or bias grainline is present.

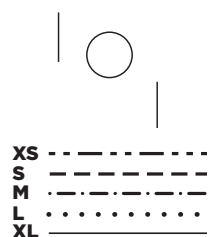
5 | Copy all pattern markings onto the wrong side of the fabric unless otherwise noted.

6 | Read through all cutting instructions listed in the project instructions for directions on how many pattern pieces to cut out of your fabric and interfacing.

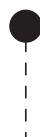
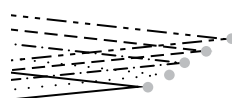
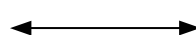
7 | Use weights to hold the pattern pieces down and use pins to secure the corners as needed.

8 | Cut the pieces slowly and carefully.

PATTERN SYMBOLS + MARKINGS



↕ place on fold ↕



BUTTON + BUTTONHOLE

PLACEMENT MARKS Solid lines indicate buttonholes. A large open circle is the button symbol and shows placement.

CUTTING LINES Multisize patterns have different cutting lines for each size.

PLACE ON FOLD BRACKET This is a grainline marking with arrows pointing to the edge of the pattern. Place on the fold of the fabric so that your finished piece will be twice the size of the pattern piece, without adding a seam.

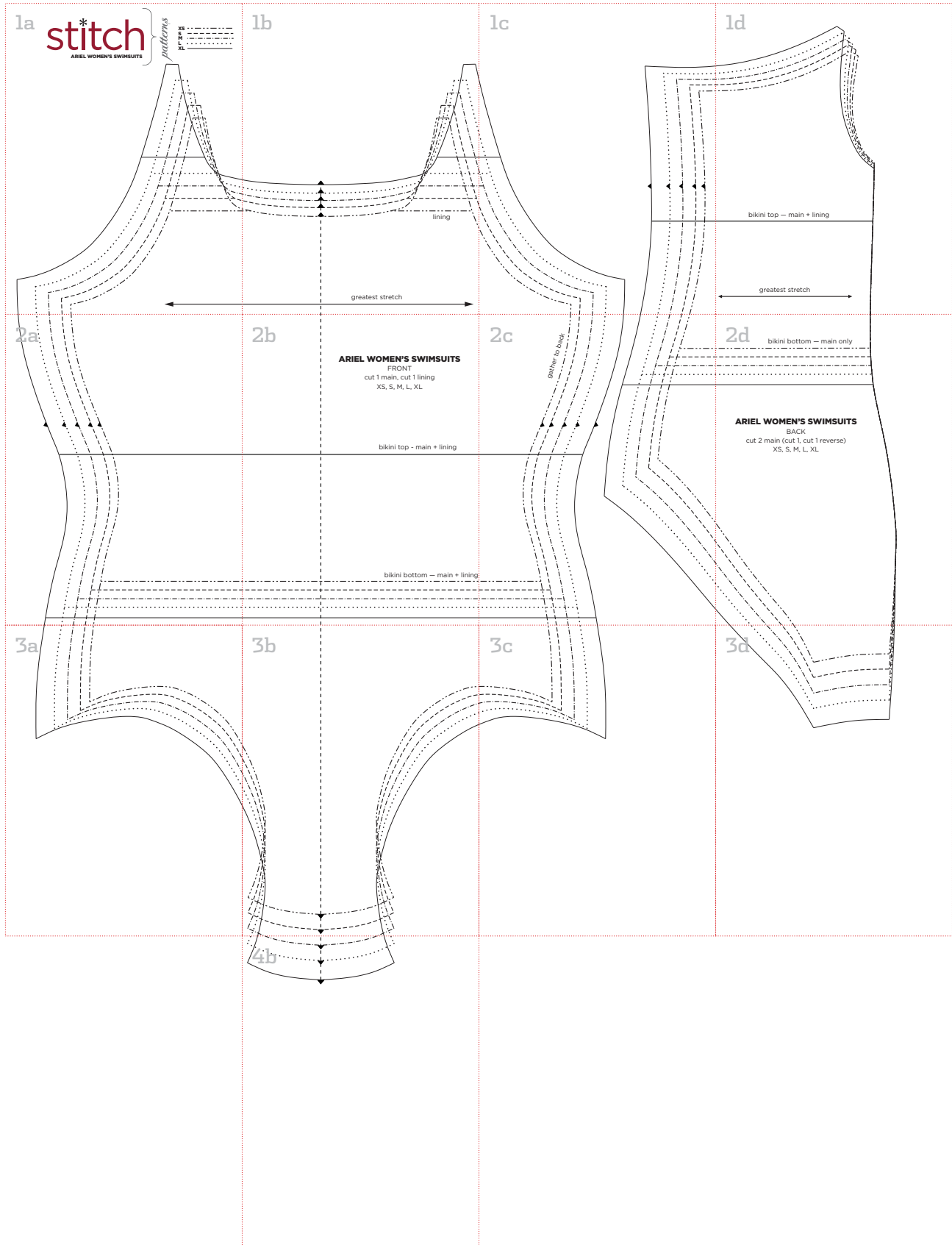
GRAINLINE The double-ended arrow should be parallel to the lengthwise grain or fold unless specifically marked as crosswise. Bias grainlines will be diagonal.

NOTCHES Notches are triangle-shaped symbols used for accurately matching seams. Pieces to be joined will have corresponding notches.

DARTS Dashed lines and dots mark darts. The dashed lines show where the stitching will be, and the dot shows the position of the dart point (signaling the point, at the end of the dart, where your stitching should end).

PATTERN DOTS Filled circles indicate that a mark needs to be made (often on the right side of the fabric) for placement of elements such as a pocket or a dart point. Mark by punching through the pattern paper only, then mark on the fabric through the hole.

SLASH MARKS A dashed line (sometimes appearing with pattern dots) indicates an area to be slashed. Further instructions for making the slash will be included in the pattern instructions.



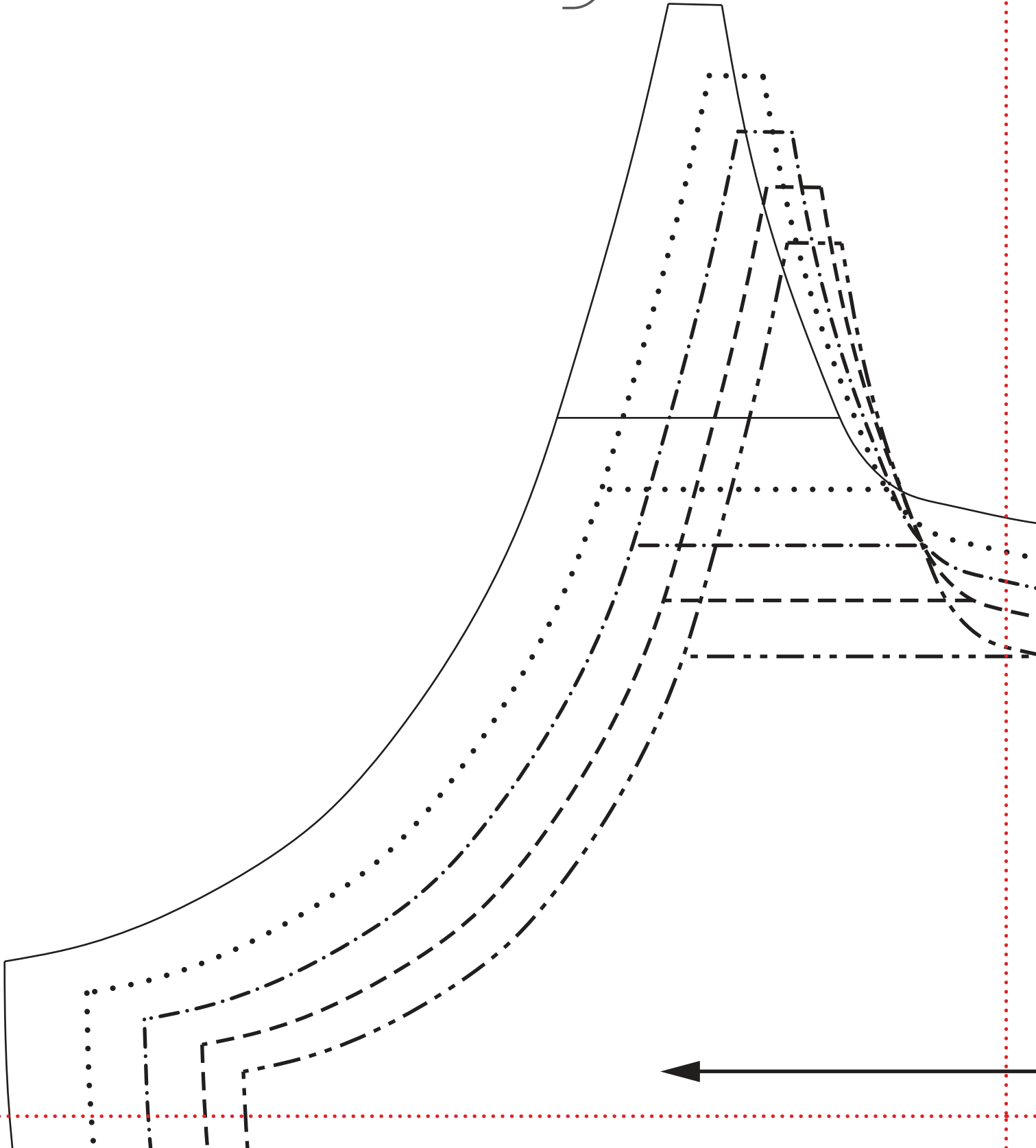
1a

stitch*

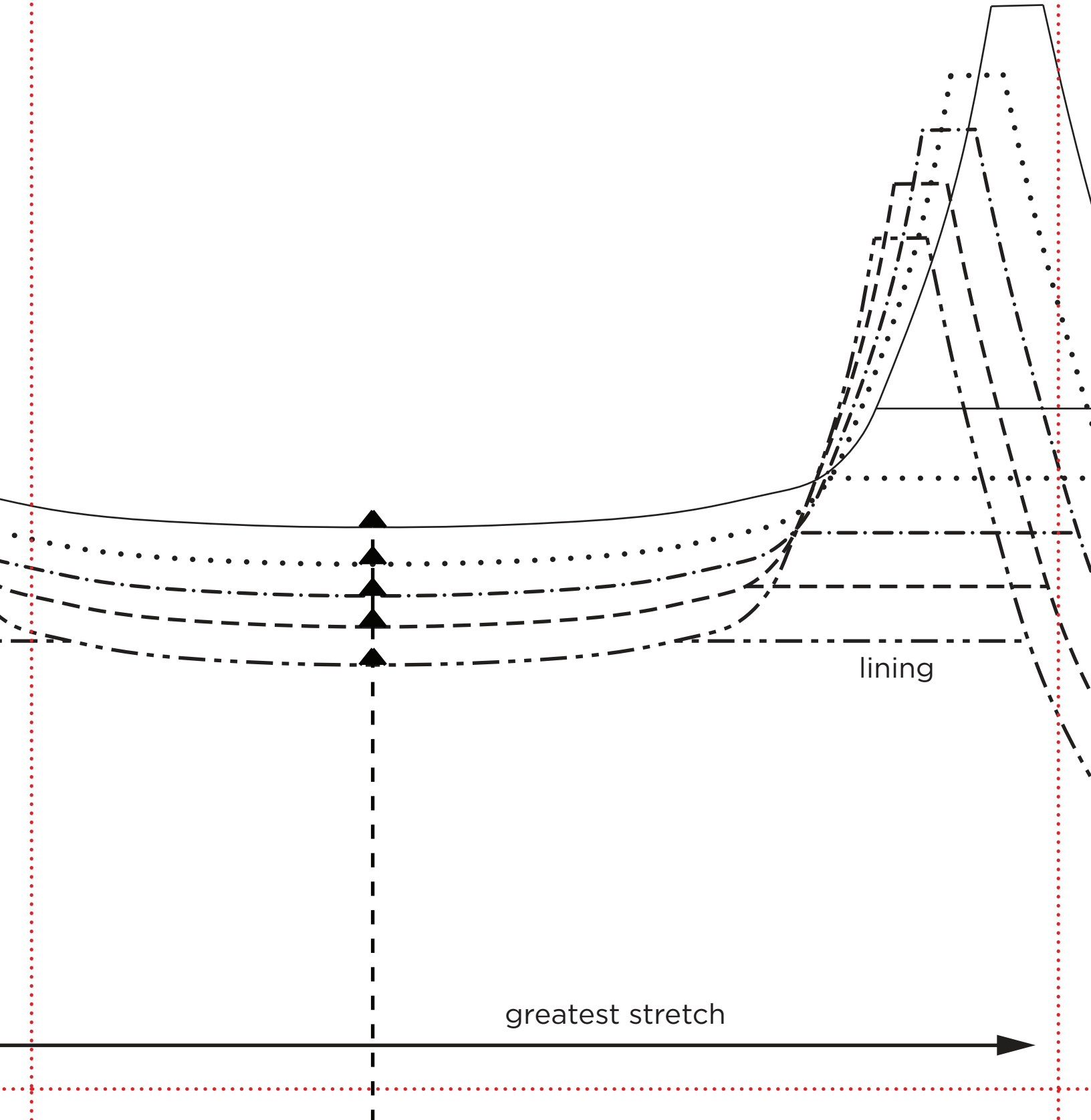
ARIEL WOMEN'S SWIMSUITS

patterns

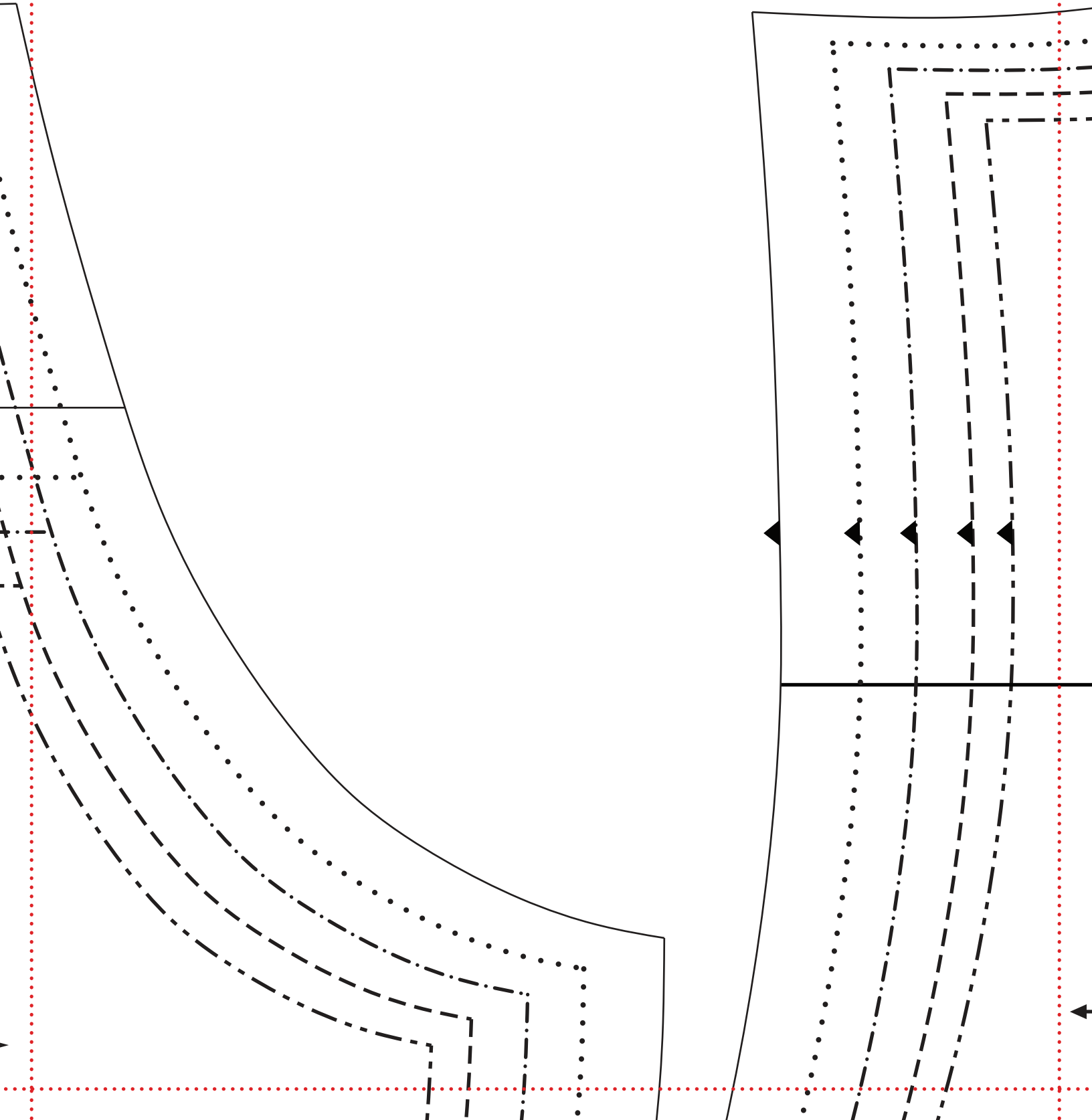
- XS - - - - -
- S - - - - -
- M - . - . - .
- L
- XL _____



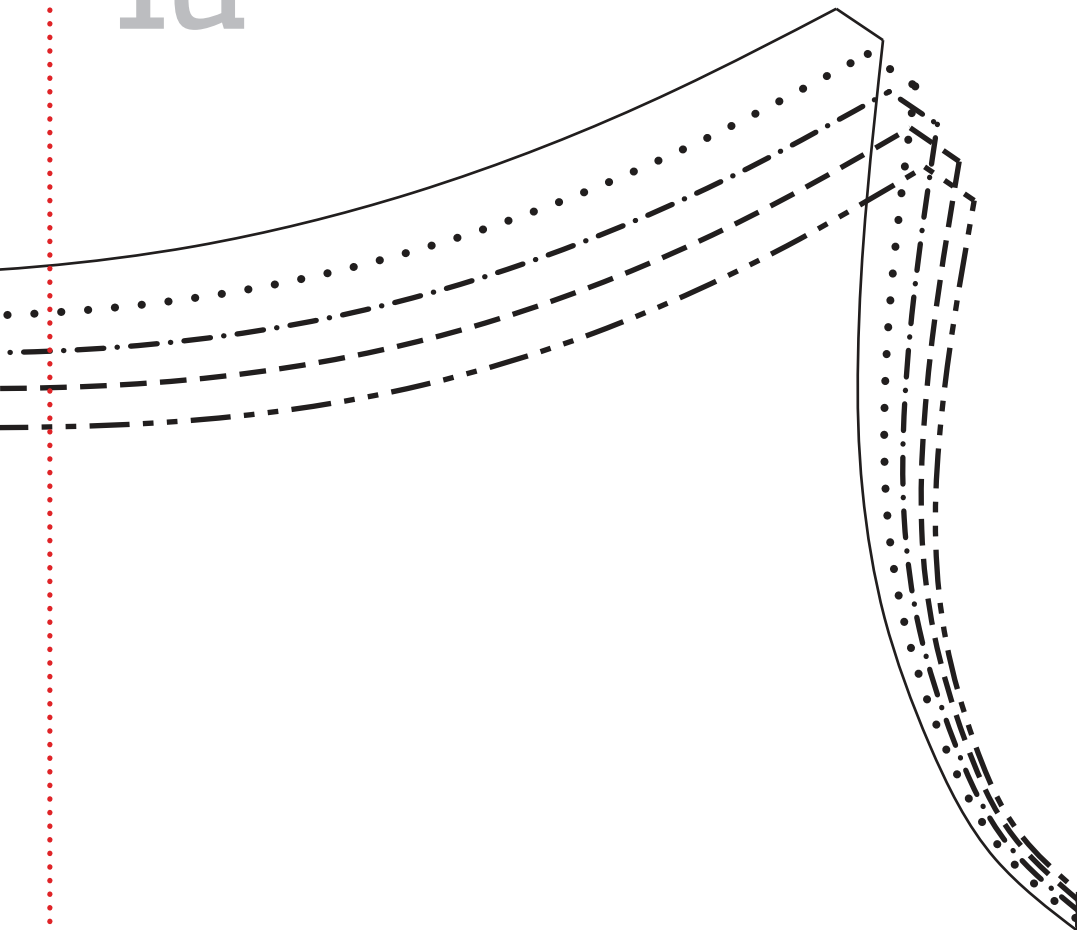
1b



1c



1d

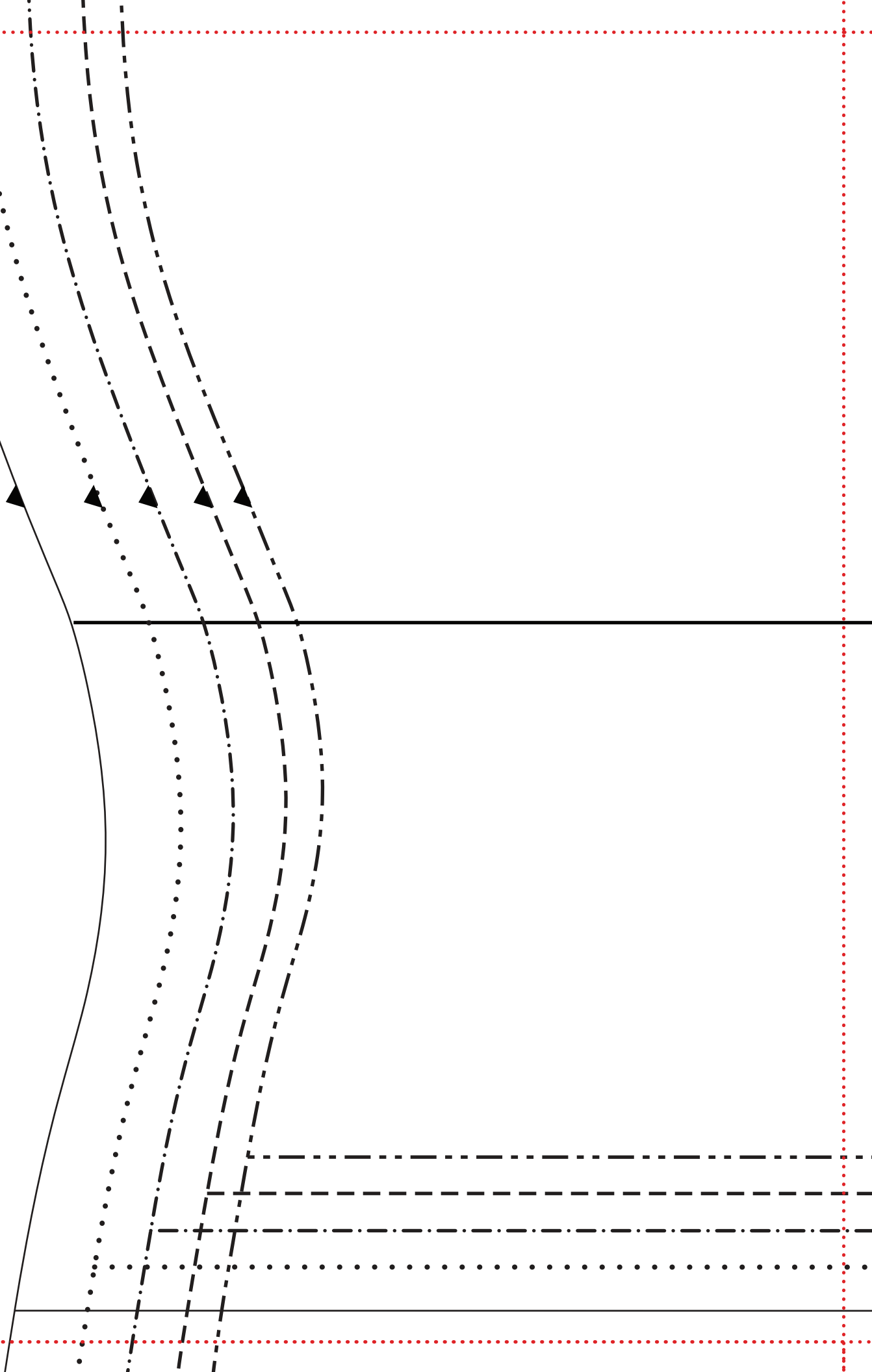


bikini top — main + lining

greatest stretch



2a



2b

ARIEL WOMEN'S SWIMSUITS

FRONT

cut 1 main, cut 1 lining

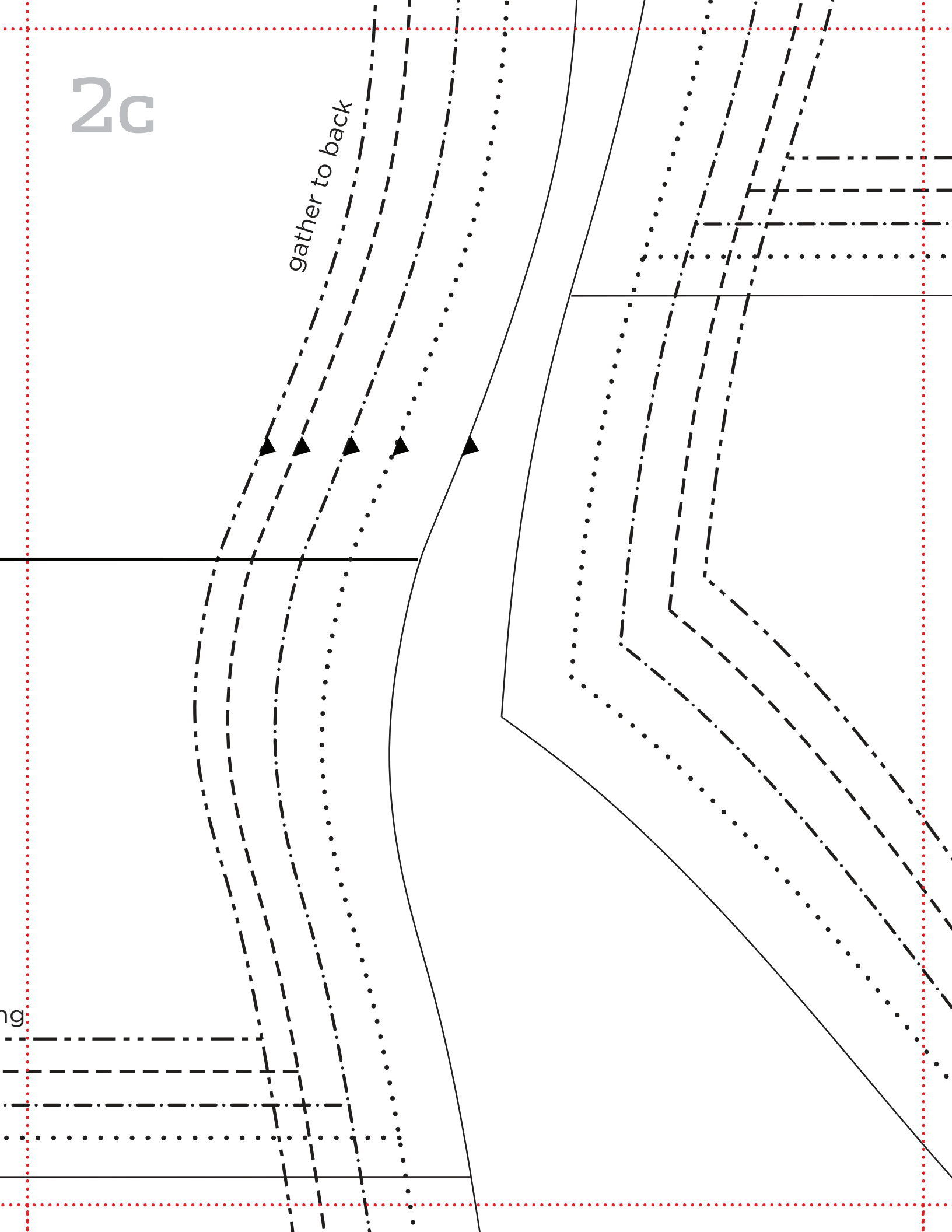
XS, S, M, L, XL

bikini top - main + lining

bikini bottom — main + lining

2c

gather to back



ng

2d

bikini bottom — main only

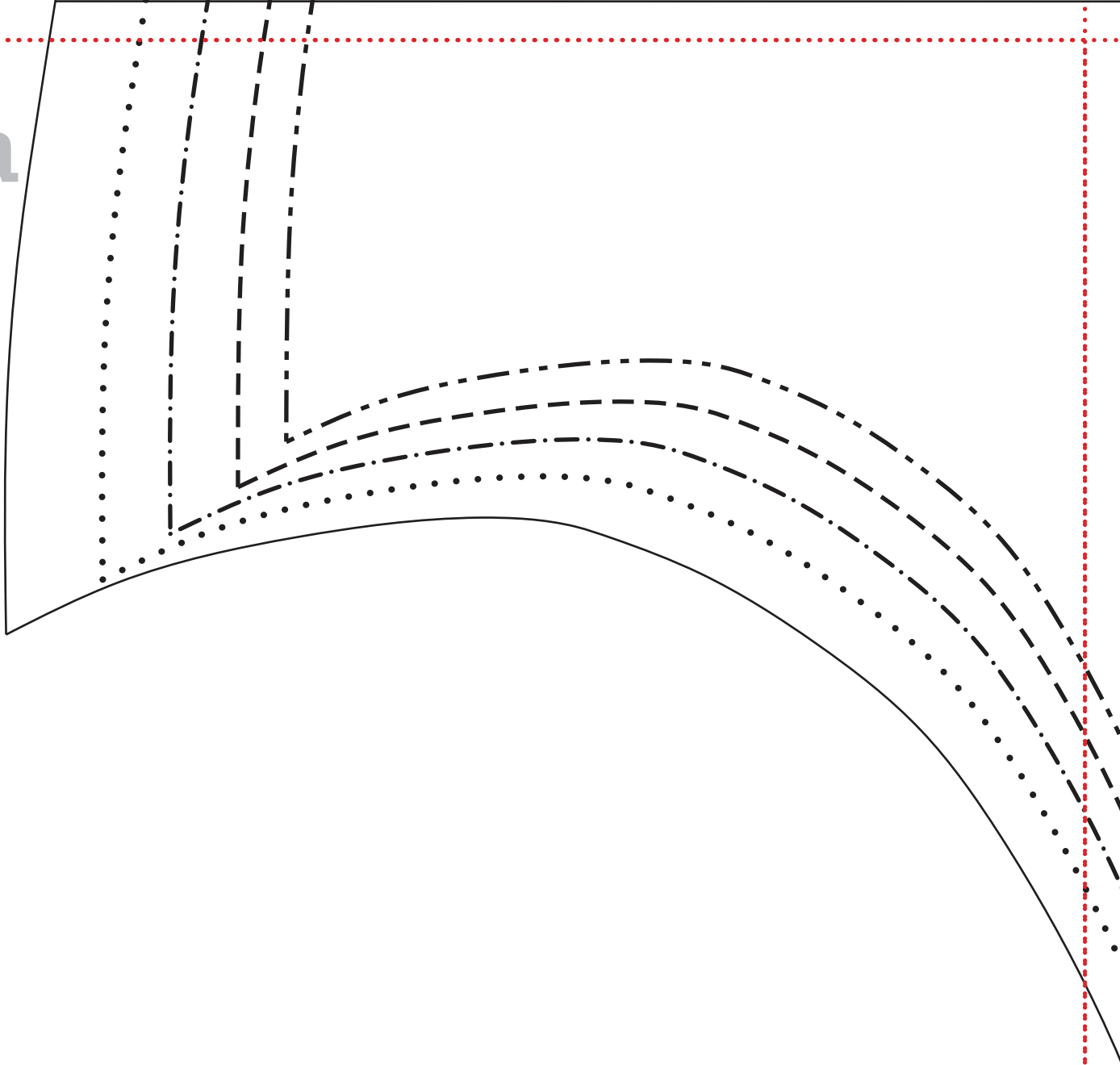
ARIEL WOMEN'S SWIMSUITS

BACK

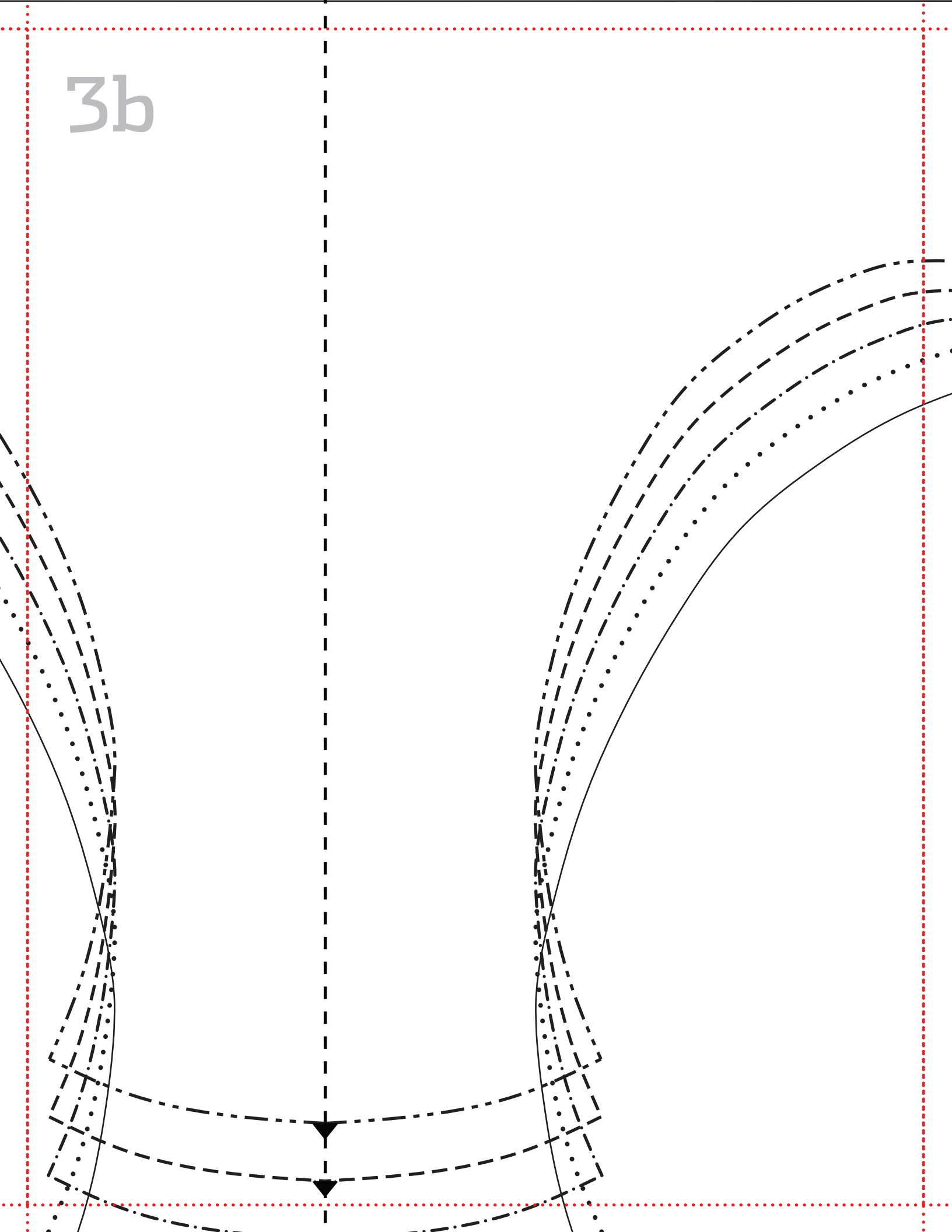
cut 2 main (cut 1, cut 1 reverse)

XS, S, M, L, XL

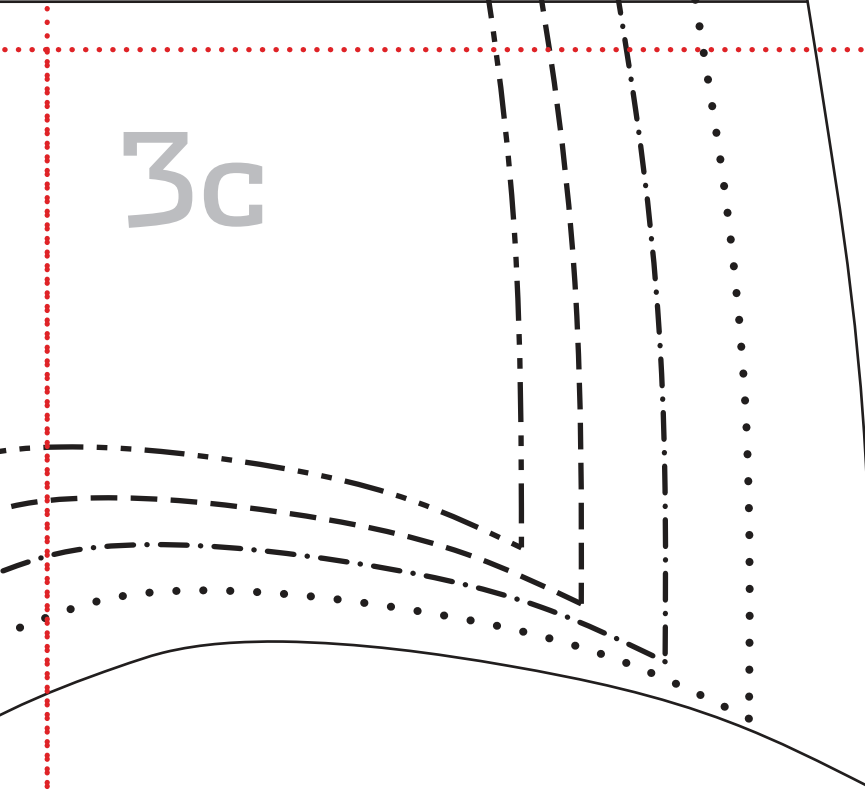
3a



3b



3c



3d

