

PRINT THIS PAGE FIRST! To make sure your printer setup correctly.
The below square should measure 1 inch x 1 inch (2.54 cm x 2.54 cm) after printing.
Allow square to have 1/16 inch (2 mm) deviation for printer calibration differences.

select

Make sure your printer is set to the same paper size that you

To save ink, set your printer to Draft or Fast Draft.



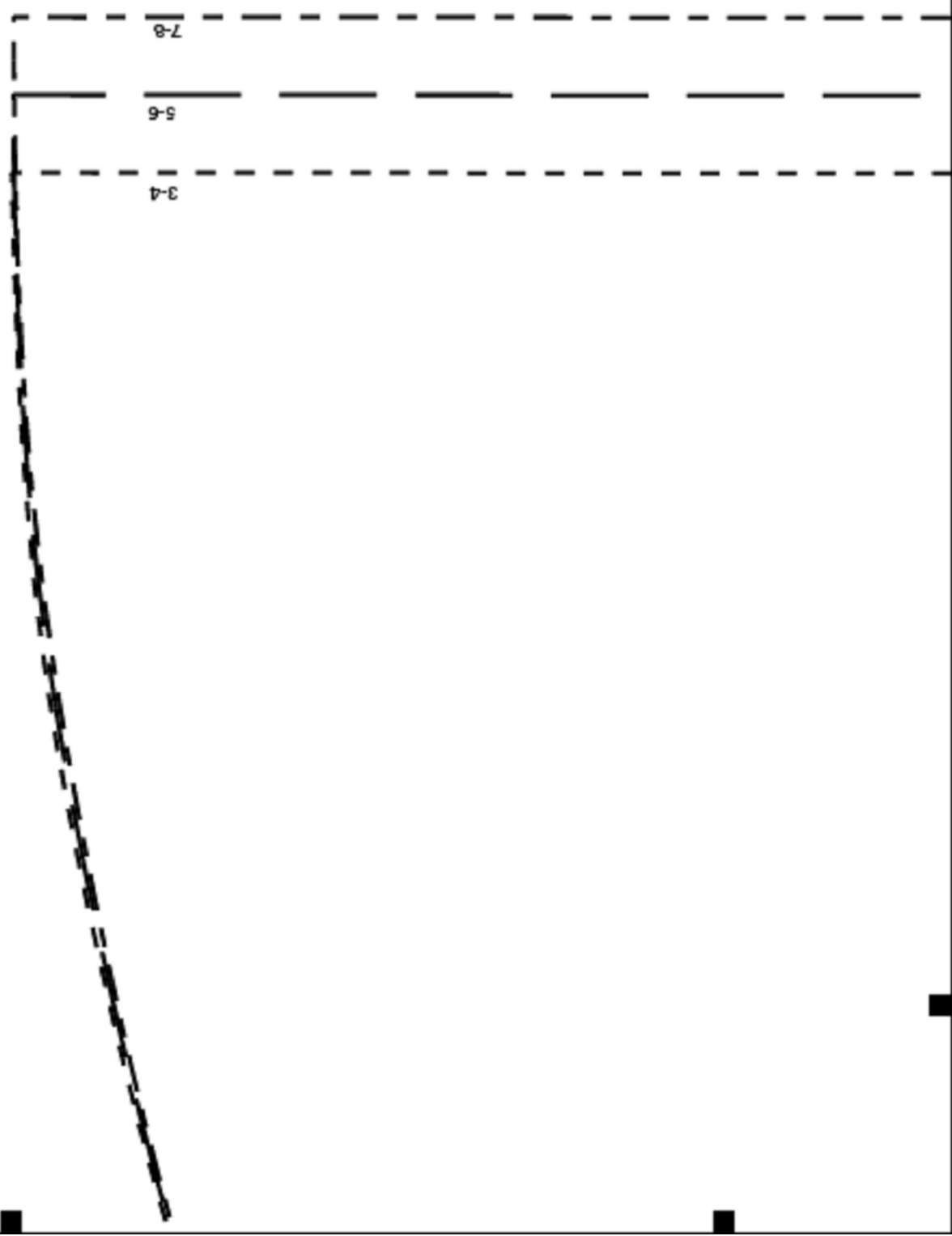

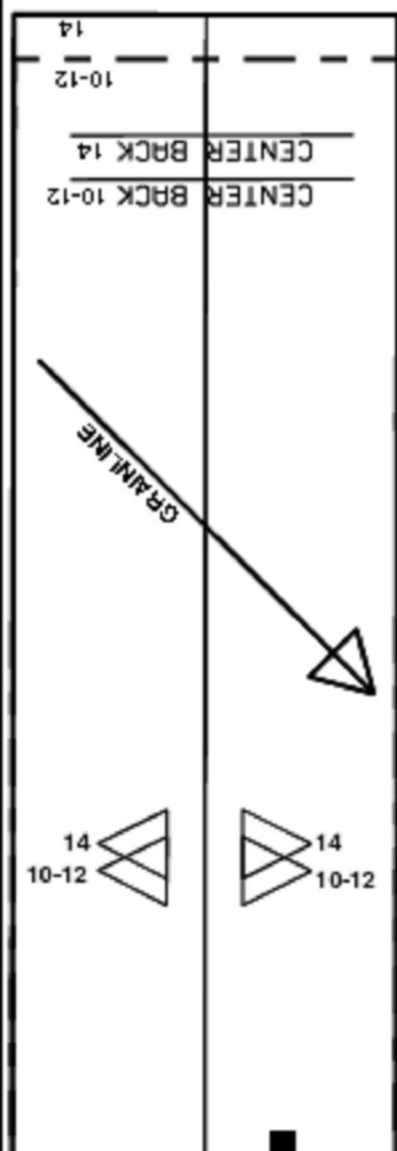

FOLDLINE

CENTER FRONT

MCCALL'S

M7000

Kids size (10-12) (14)

NECK FACING A B

PARÈMENTURE D'ENCOLURE

VISTA DEL ESCOTE

HALSAUSSCHNITTBELEG

MOSTRA PER IL COLLO

Contrast 2: Cut 1

10-12
14



10-12
14

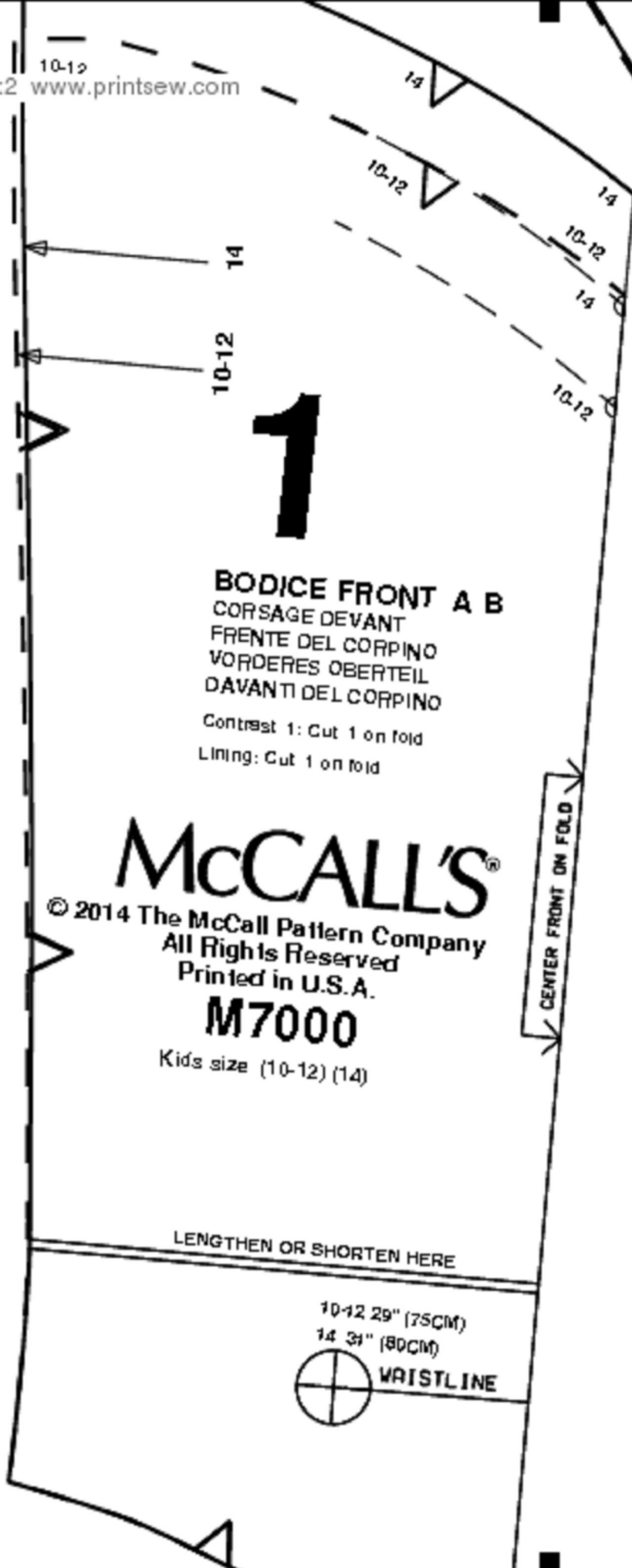

1

BODICE FRONT A B
CORSAGE DEVANT
FRENTE DEL CORPINO
VORDERES OBERTEIL
DAVANTI DEL CORPINO

Contrast 1: Cut 1 on fold
Lining: Cut 1 on fold

MCCALL'S®

© 2014 The McCall Pattern Company
All Rights Reserved
Printed in U.S.A.

M7000

Kids size (10-12) (14)

CENTER FRONT ON FOLD

LENGTHEN OR SHORTEN HERE

10-12 29" (75CM)
14 31" (80CM)



WAISTLINE

CENTER	BACK	10-12
CENTER	BACK	14

10-12
14

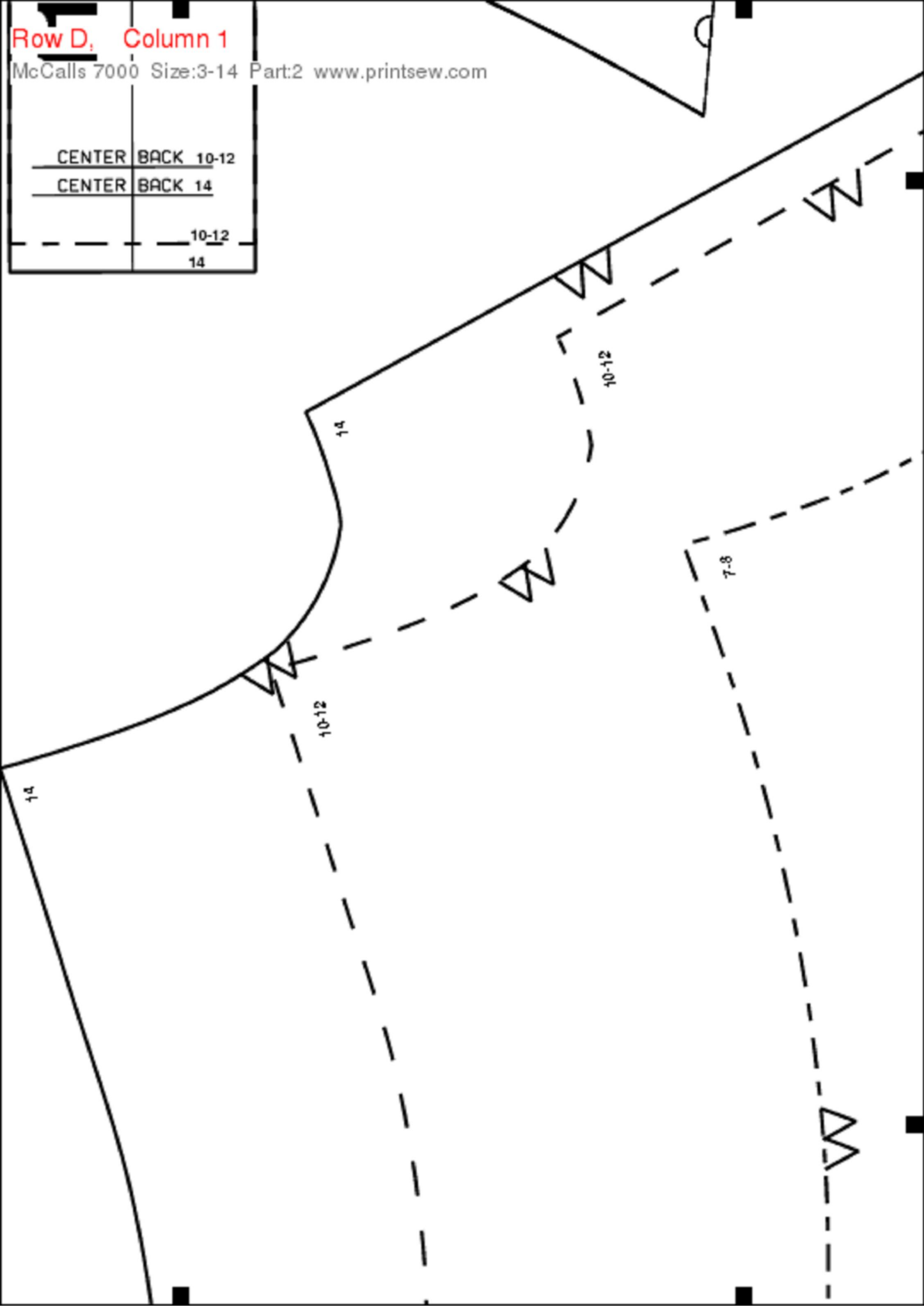

Row E, Column 1

McCalls 7000 Size:3-14 Part:2 www.printsew.com

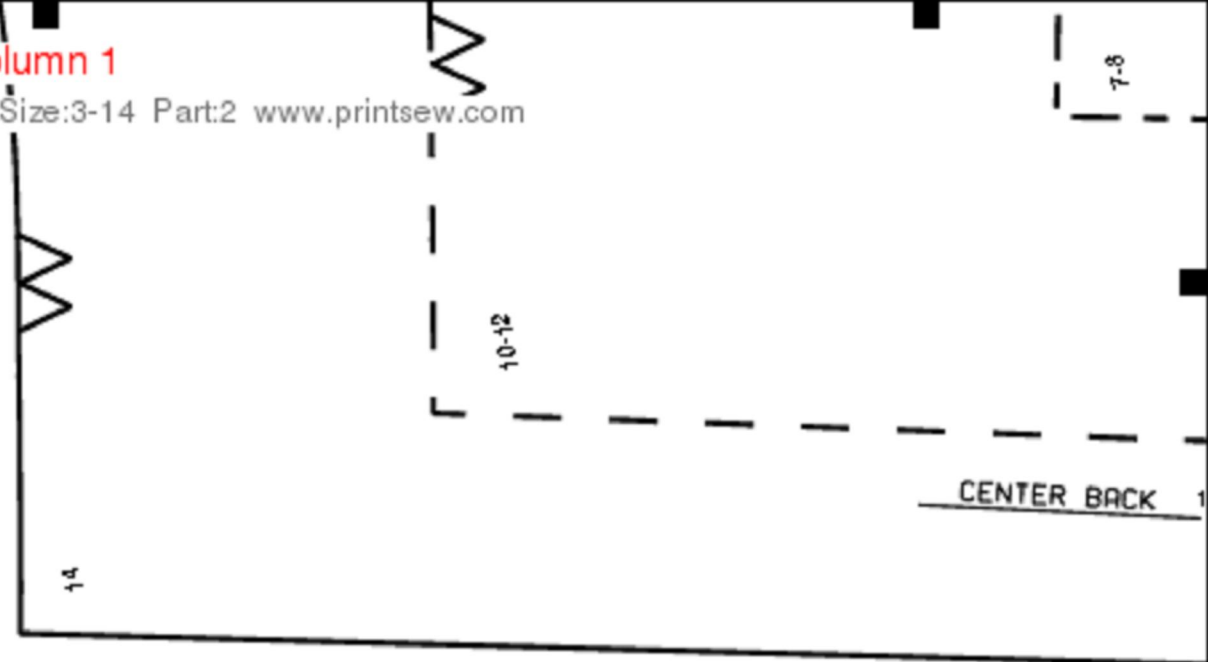

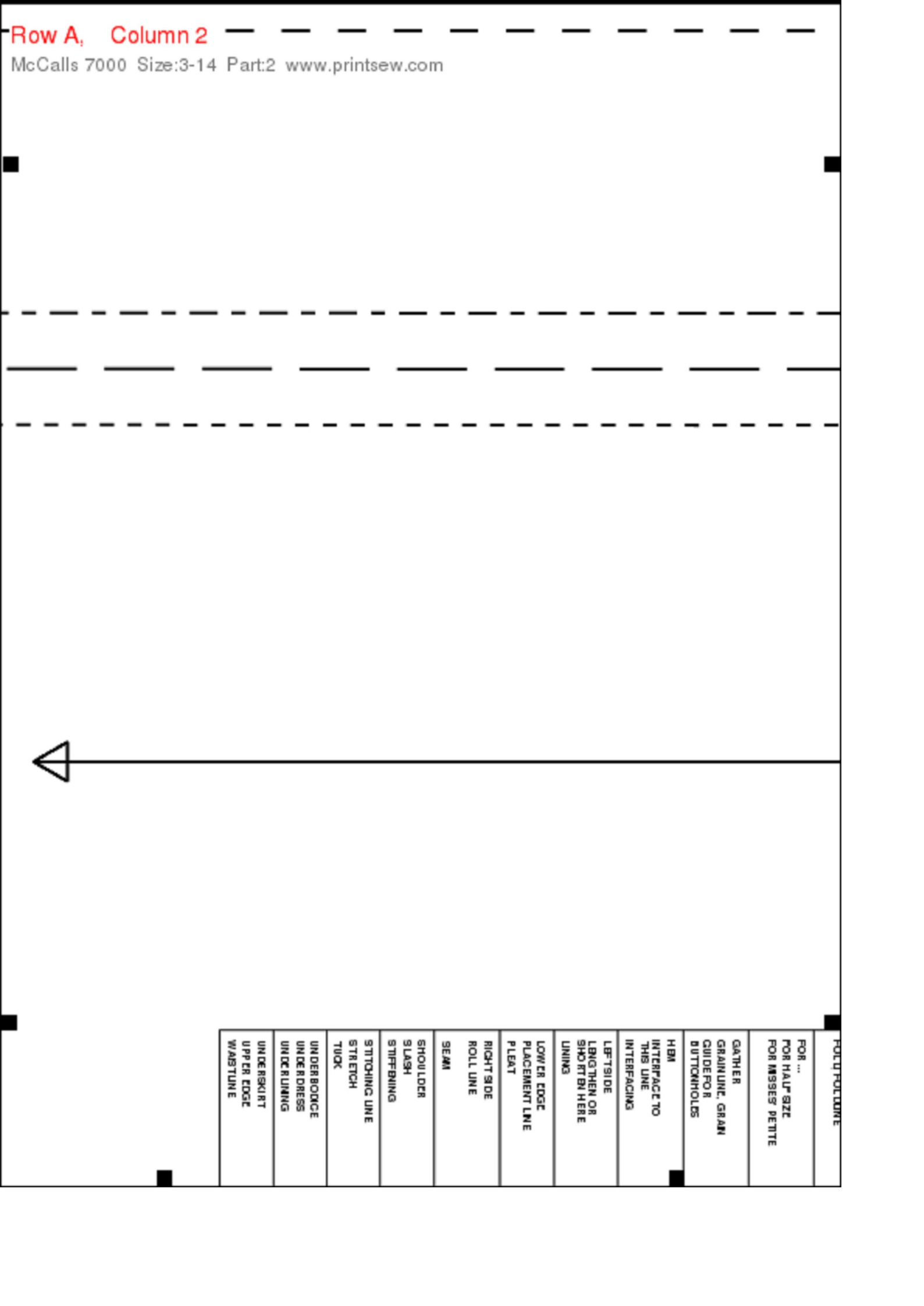

FOLD FOLDLINE
FOR ... FOR HALF SIZE FOR MISSES' PETITE
GATHER GRAINLINE, GRAM GUIDE FOR BUTTONHOLES
HBM INTERFACED TO THIS LINE INTERFACING
LEFTSIDE LENGTHEN OR SHORTEN HERE LINING
LOWER EDGE PLACEMENT LINE PLEAT
RIGHT SIDE ROLL LINE
SEAM
SHOULDER SLASH STIFFENING
STITCHING LINE STRETCH TUCK
UNDERBODICE UNDERDRESS UNDERLINING
UNDERSKIRT UPPER EDGE WAISTLINE

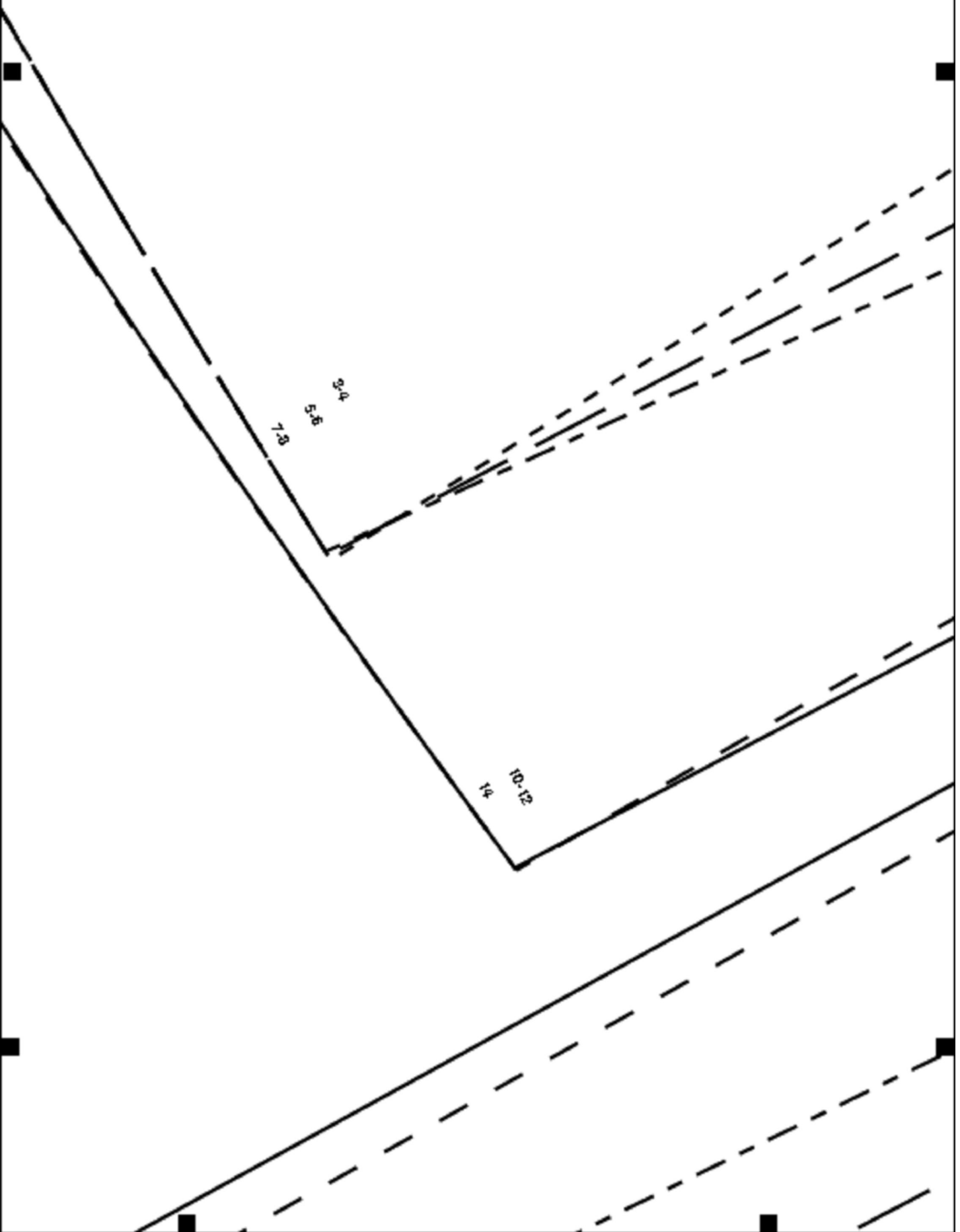

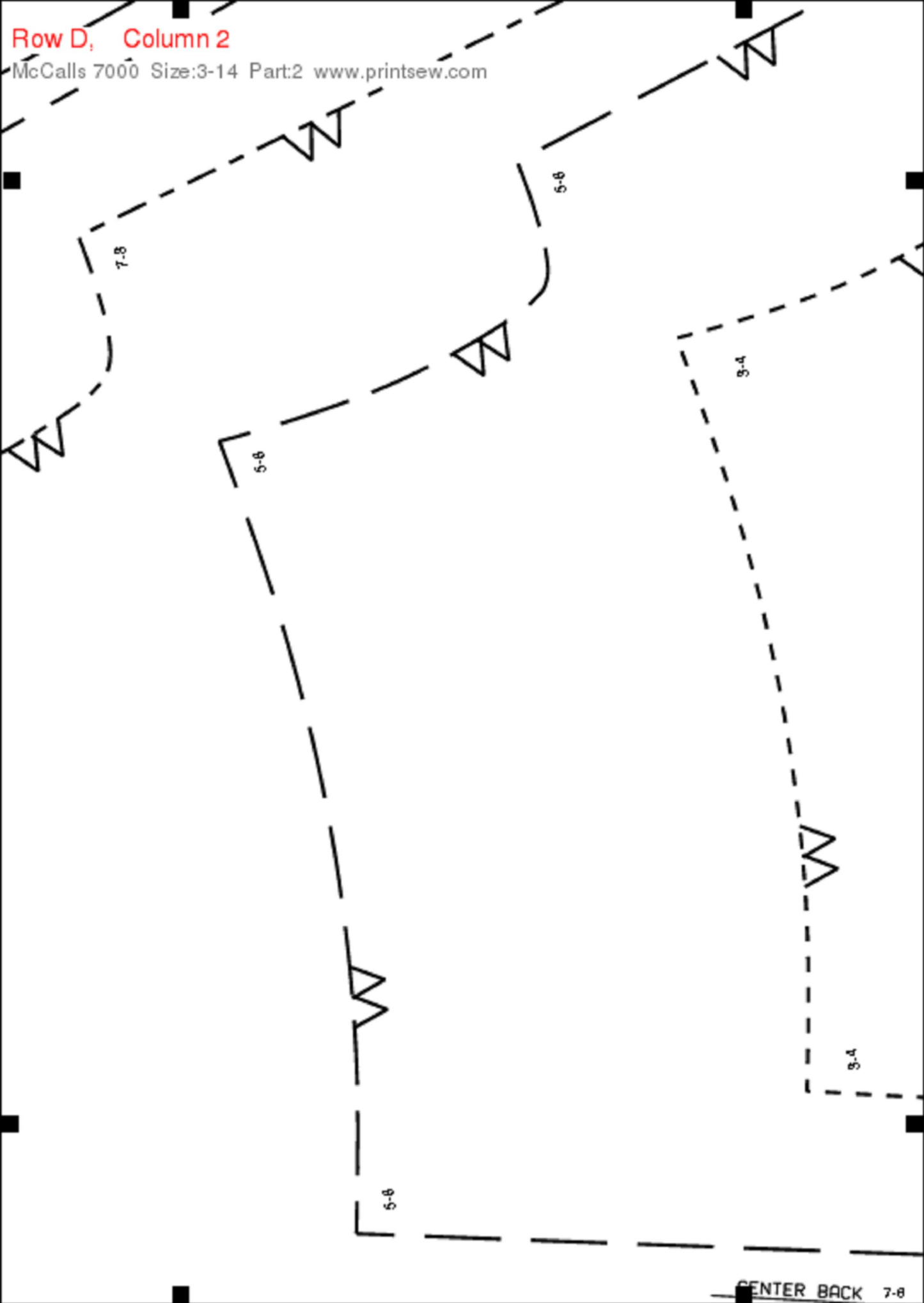

CENTER BACK 10-12

4

HEM 5/8" (1.5 CM)

HEM 5/8" (1.5 CM)

WRISTLINE 3-4

MCCALL
M7000
Kids size (3-4) (5-6) (7-8) (10-14)

**PATTERN
GLOSSARY**

ENGLISH

APPLICATION
BLOUSING
CASING
CENTER

CENTER BACK
CENTER FRONT
CONTRAST

CROTCH LINE
CUT ...
CUT OFF FOR ...

CUT ... ON FOLD

DRESS
EASE

FABRIC
FACING

GLOSSAIRE GLOSSARIO SCHNITT- GLOSSARIO PATROON-
 DEL PATRON DEL PATRON ERKLARUNGEN PER MODELLI VERKLARINGEN

FR/ICAIS	ESPAÑOL	DEUTSCH	ITALIANO	NEEDERLANDS
APPLIC PARTI COUJUI MIEU	APPLICACION ABUSADO JARCTA CENTRO	APPLIKATION ÜBERFALL FÜR DURCHZUG MITTE	APPLICAZIONE BLUSANTE GUAINA CENTRO	APPLIQUE BLUESAND TUNNENVOOTJE MIDDE
APPLIC PARTI COUJUI MIEU	CENTRO DE LA ESPALDA CENTRO DEL FRENTE CONTRASTE	RÜCKW. MITTE VORDERE MITTE KONTRAST	CENTRO DI ETRO CENTRO DAVANTI CONTRASTO	MIDDE ACHTER MIDDE DEL FRENTE MONT RAAST
APPLIC PARTI COUJUI MIEU	LÍNEA DEL TIRÓ CORTAR ... CORTAR AQUÍ PARA ...	SCHRITTUNGE .. X ZUSCHNEIDEN ABSCHNITTEN FÜR ...	LINEA DEL CAVALLLO TAGUARE ... TAGUARCOU PER ..	KRUISLIJN .. X KNIPPEN .. X KNIPPEN VOOR ...
APPLIC PARTI COUJUI MIEU	CORTAR ... AL DOBLIZ VESTIDO ACOMODAR	.. X AM STOFFBRUCH ZUSCHNEIDEN KLBD BNHALTEN	TAGUARE ... SULLA REGIA ABITO ACCOMODARE	.. AAN STOFVUW LEGGEN JUIK NIHOUDEN
APPLIC PARTI COUJUI MIEU	TELA VISTA	STOFF BELEG	TESSUTO MOSTRA	STOF BELLEG

Row B, Column 3
 McCalls 7000 Size: 3-14
 www.printsew.com

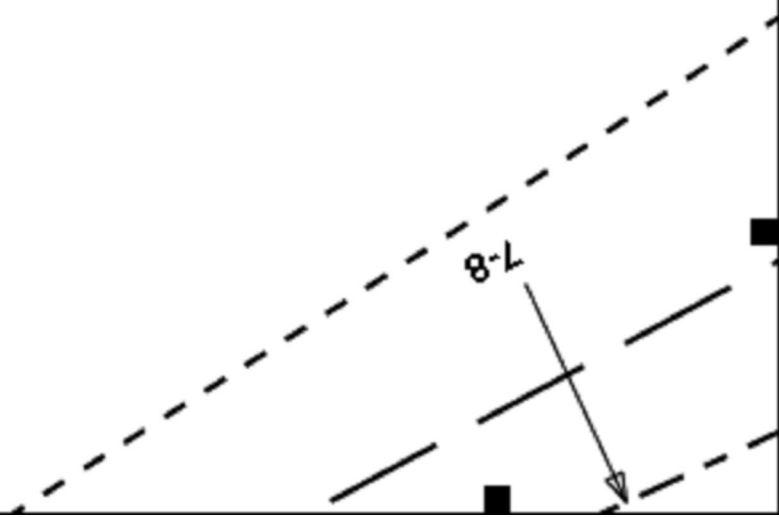

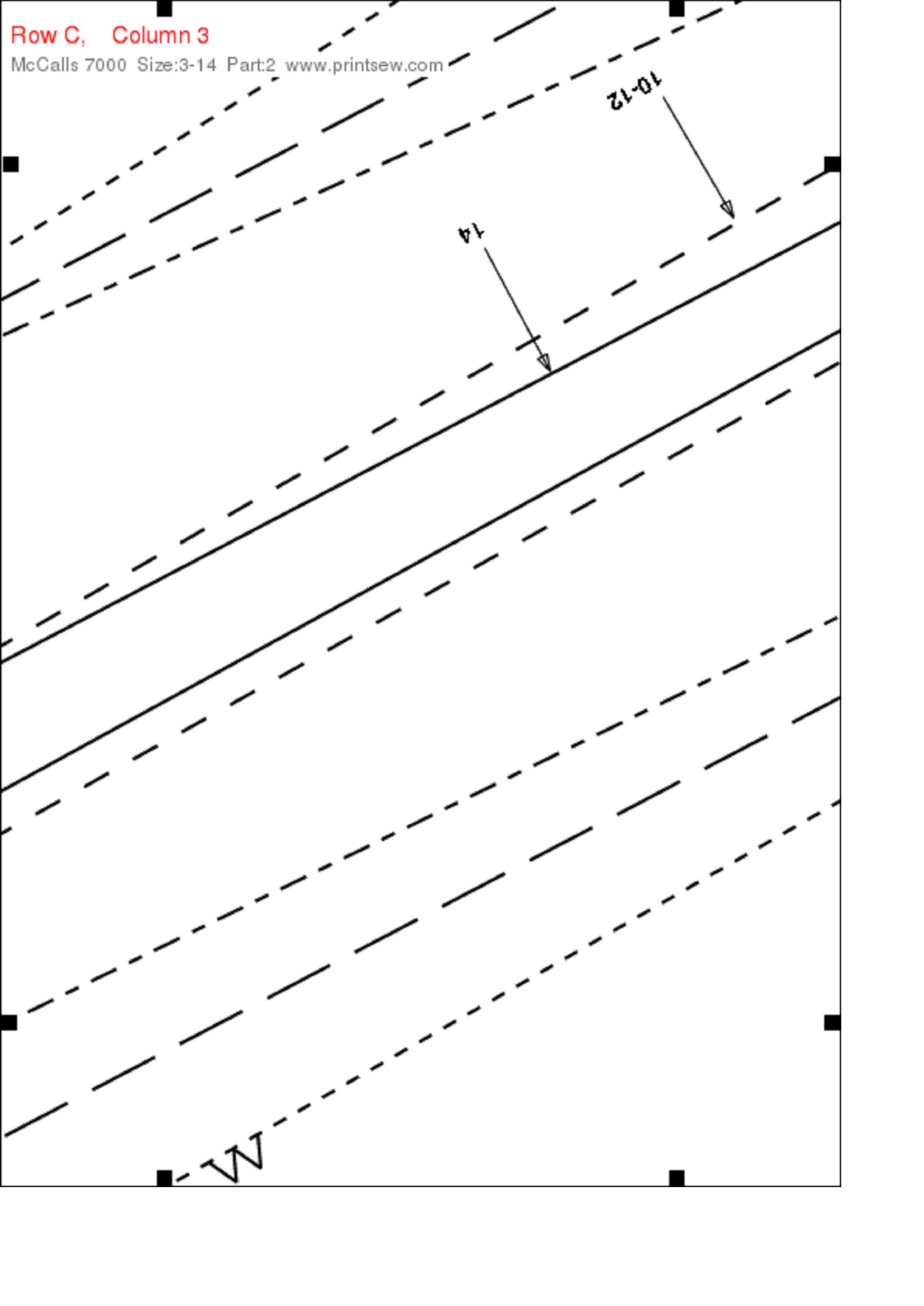

W



7

BACK OVERLAY B

DOS SUPERPOSE
ESPALDA SUPERPUESTA
AUFGELEGTES RÜCKENTEIL
DIETRO SOVRAPPOSTO

CONTRAST 2: Cut 2

MCCALL'S

GRAINLINE

CENTER BACK 3-4

CENTER BACK 5-6

HEM 5

HEM 5/8" (1.5 CM)

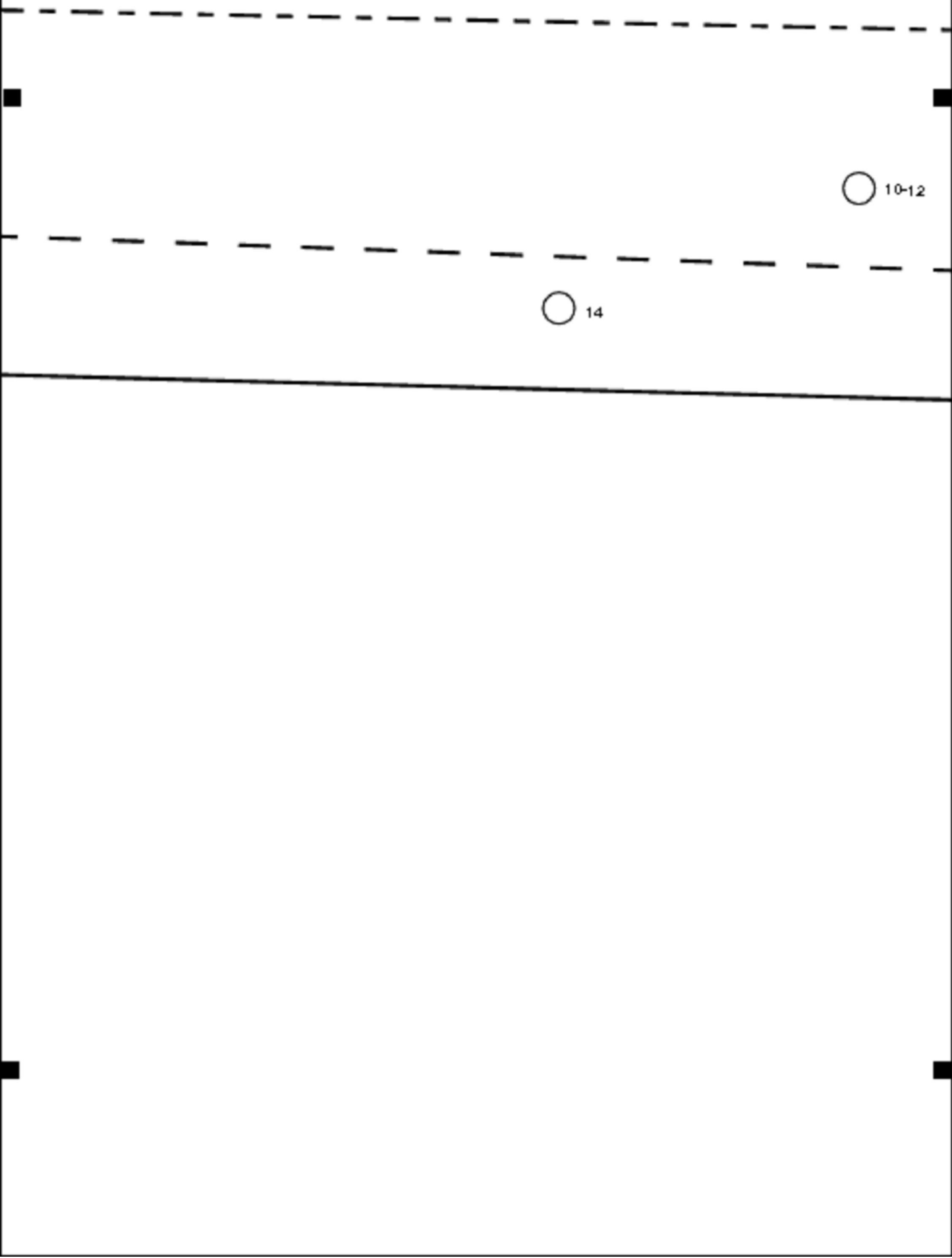

WRISTLINE 10-12

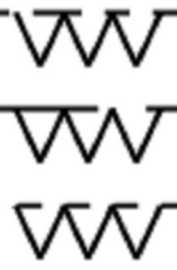

WRISTLINE 7-8

WRISTLINE 5-6

CENTER BRCK 7-8

CENTER BRCK 5-6

CENTER BRCK 3-4

GRAINLINE

15

BACK C

DOS
ESPALDA
RÜCKENTEIL
DIETRO

Fabric: Cl

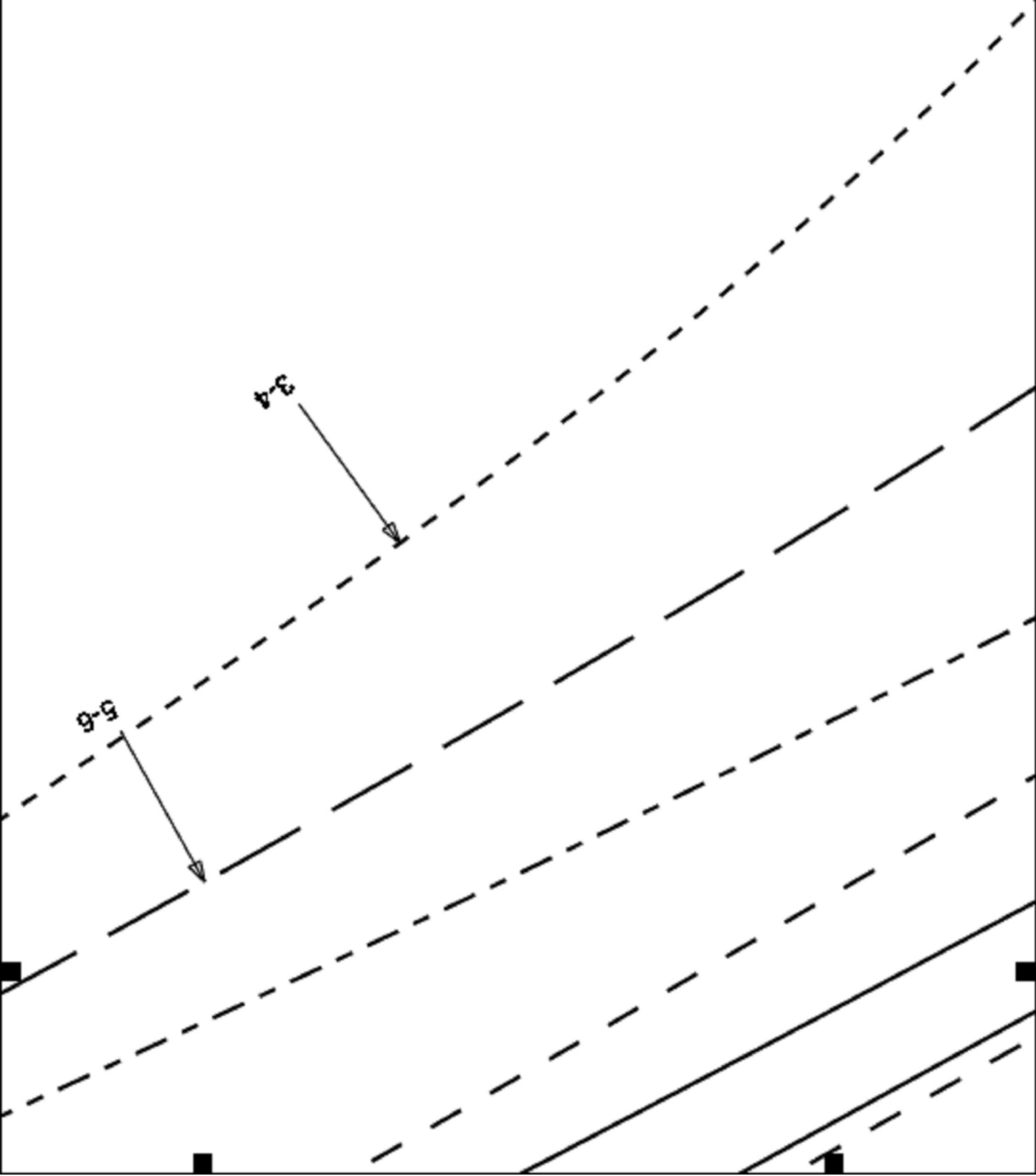

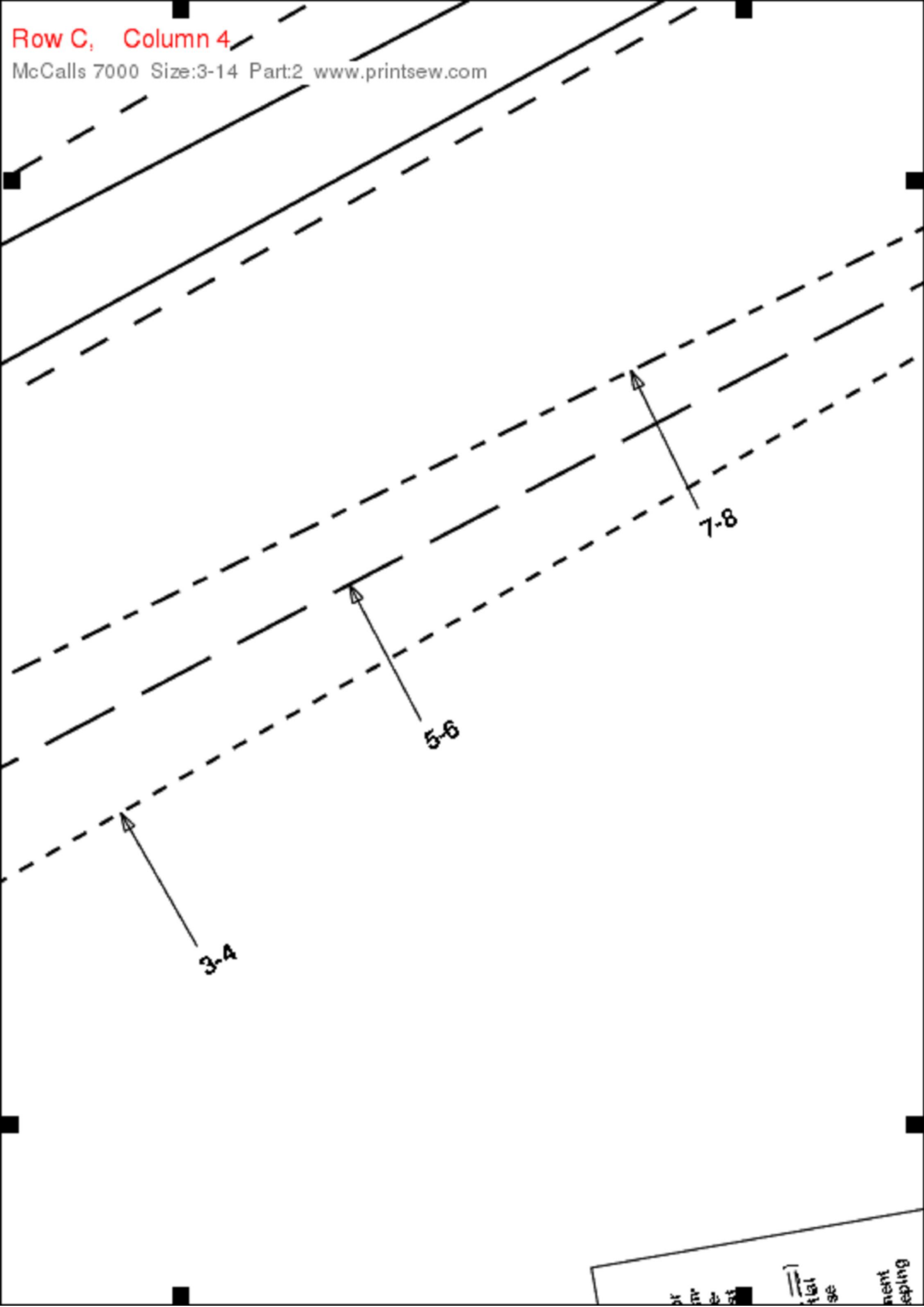

of
m
e
st
[Symbol]
tial
se
ment
eping

M7000
Kids size (3-4) (5-6) (7-8) (10-12) (14)

1.5 CM

5-8

PREPARING PATTERN

⊕ Indicates the Bustline, Waistline and Biceps. Measurements refer to circumference of Finished Garment (Body Measurement + Wearing Ease + Design Ease). Adjust pattern if necessary.

Lengthen or Shorten at adjustment lines (or where indicated on pattern. If substantial length is added, you may need to purchase additional fabric.

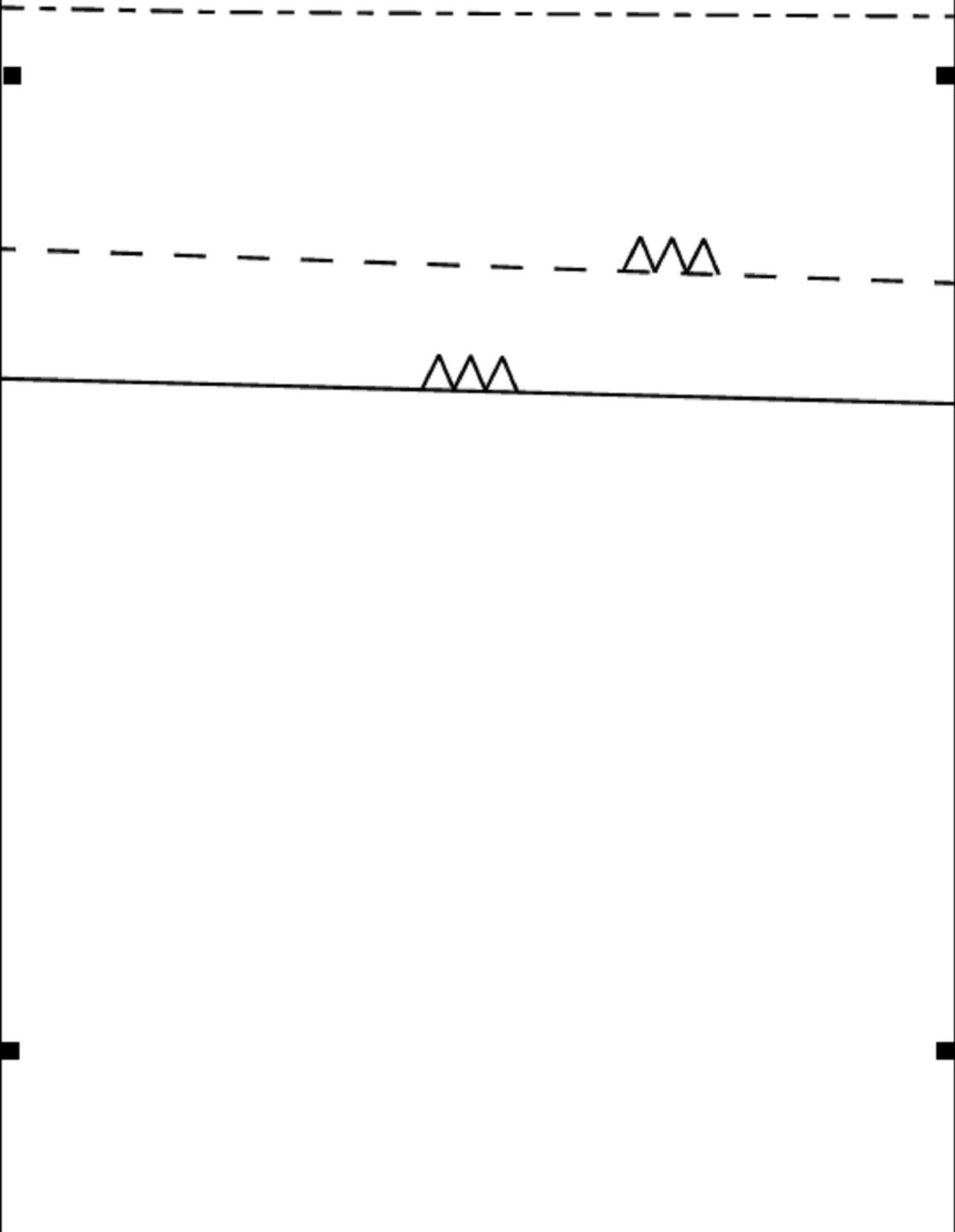

CENTER BACK 14

CENTER BACK 10-12

WRISTLINE 14

5-6

5-6

3-4

3-4

5-6

3-4

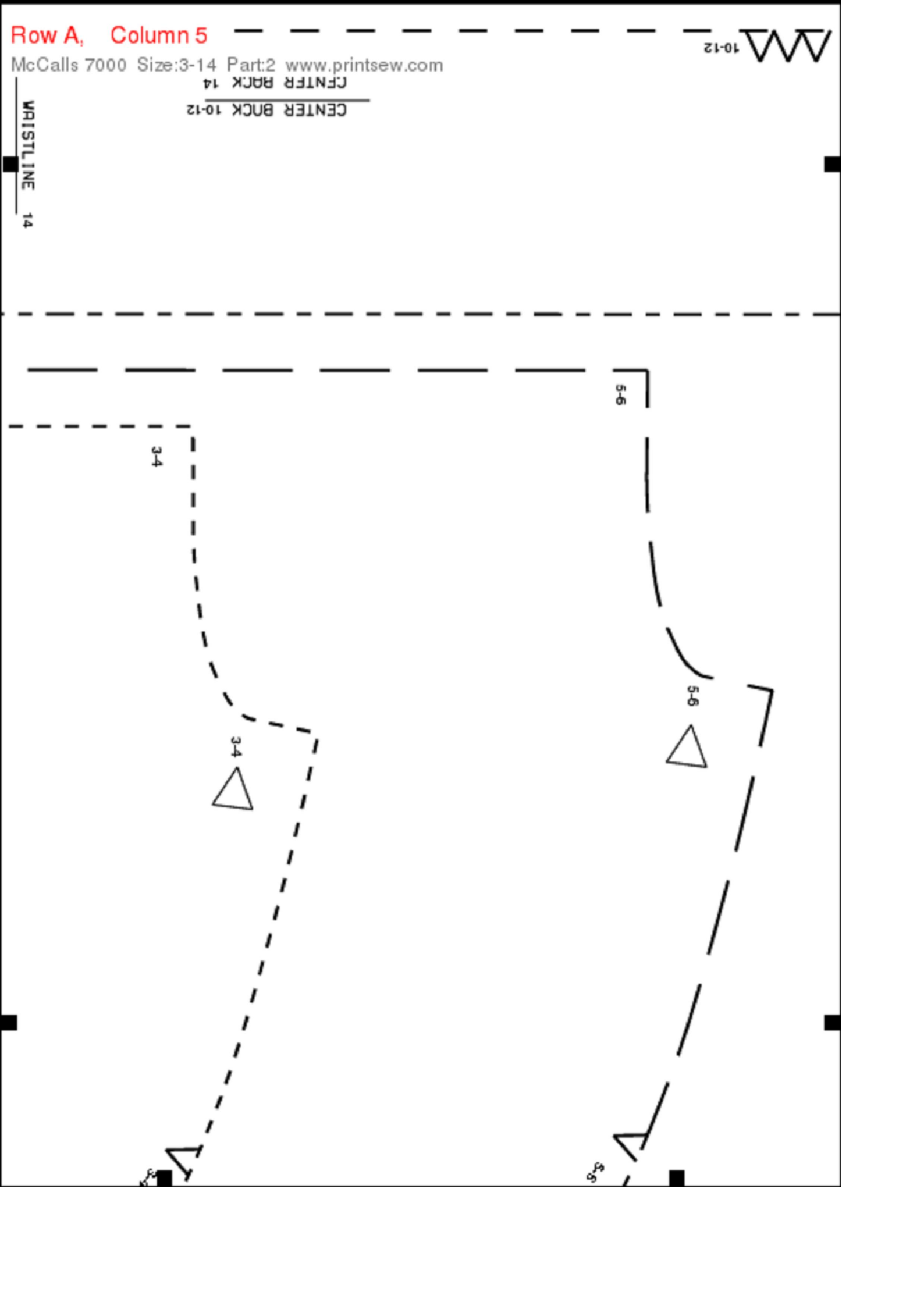

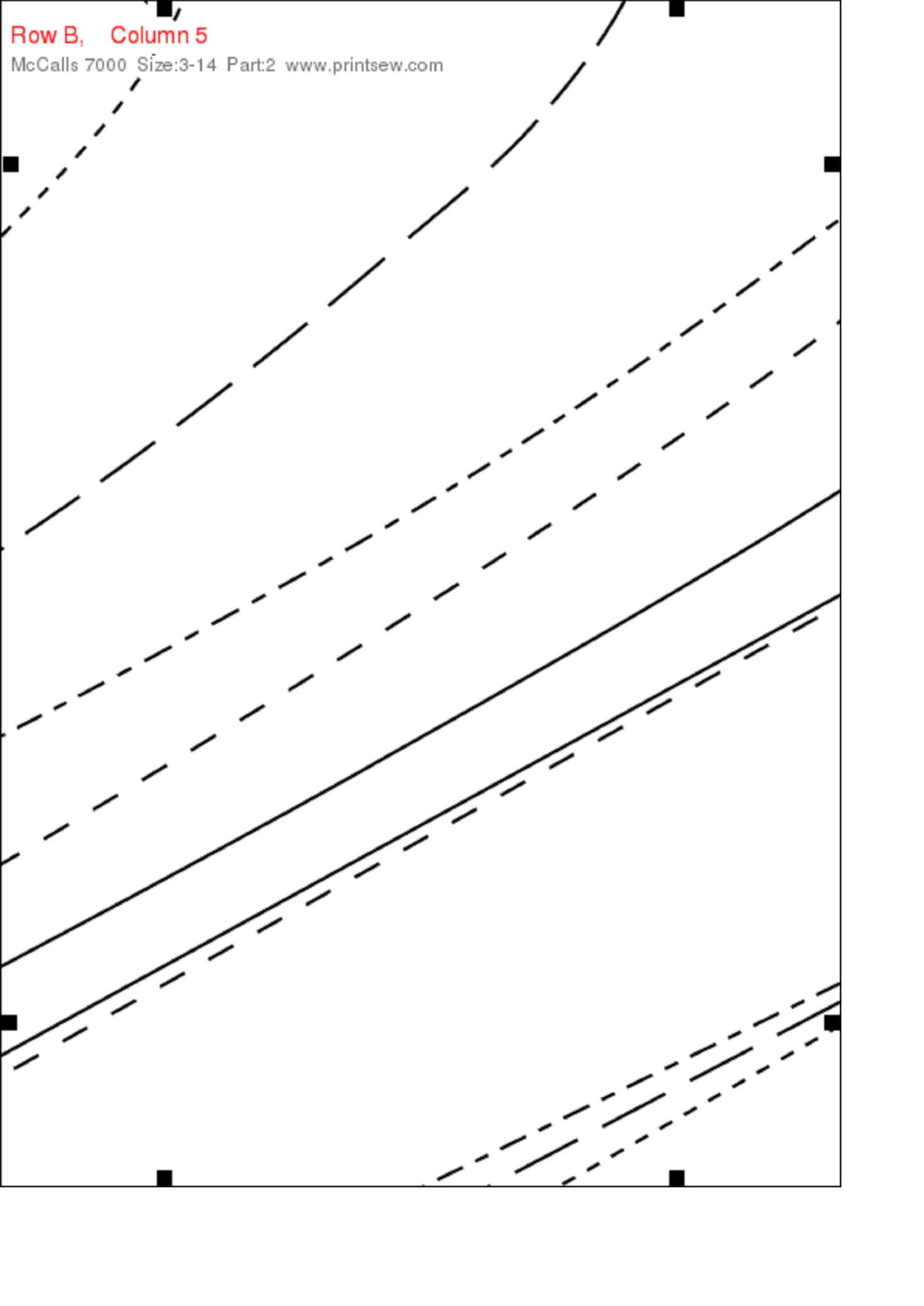

ent line.
d.
before re-
right side



lines, etc., are
desired.

DU PATRON

trine, lignes de taille,
ant-bras. Ces mesures
erence du vêtement fini
ce confort + Aisance
si nécessaire.

aux lignes de rectifi-
pli indique sur le patron.
important, un excès de
essaire.

entre les lignes de rec-
bords (paralèlement)
queur désirée.
er un pli à une des lignes
exemple: pli de 1cm pour

peres sur l'envers du tissu
atron. Les repères à reporter
marques au fil.

- To Lengthen - amount as indicated in the pattern.
- To Shorten - Crease along the fold line. Spread the edges parallel.
- Make a fold half the amount of the lengthening or shortening.
- Transfer all tissue markings to the fabric. Markings on the pattern should be transferred to the fabric.
- Seamlines - 5/8" (15mm) unless otherwise indicated.
- Button Marking - Indicate the placement of buttons.
- Buttonhole Marking - Indicate the exact length and placement of buttonholes.
- Symbols - For marking and construction.
- Centers, Foldlines, etc. - Trace clearly marked, through the fabric.

PREPARATION

- Indique: pointe de pointe de hanches et/ou avants sont basées sur la circonférence du corps + Alsar (Mesures du corps + Alsar mode). Ajuster le patron si nécessaire.
- Rallonger ou raccourcir le patron () ou à l'endroit de la longueur est indiqué. Si le rallongement est nécessaire, le tissu peut s'averer nécessaire.
- Rallonger - Couper le tissu en conséquence. Espacez les coutures pour obtenir la longueur souhaitée.
- Raccourcir - Formez des plis de rectification. Espacez les coutures de raccourcir de 2cm.
- Reporter tous les repères avant d'enlever le patron.

3-4

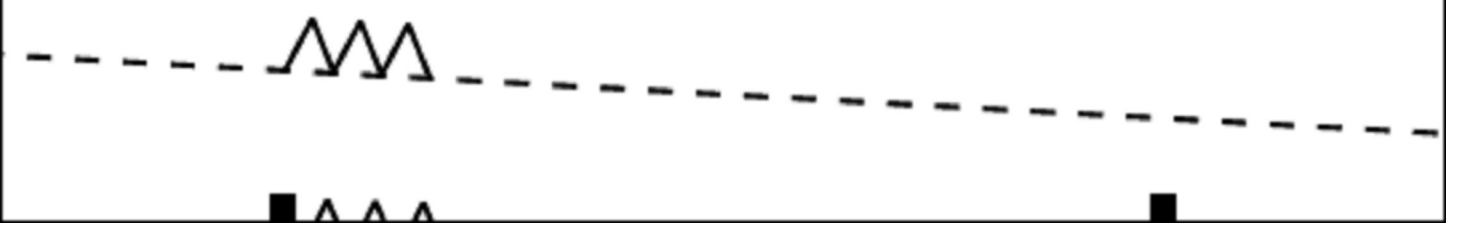

Row E, Column 5

McCalls 7000 Size:3-14 Part:2 www.printsew.com

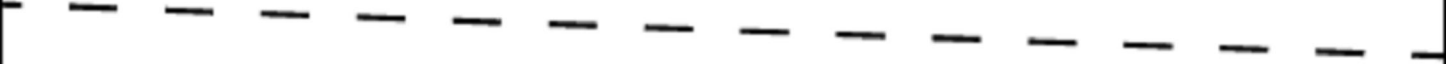

10-12

7-8

10-12

10-12





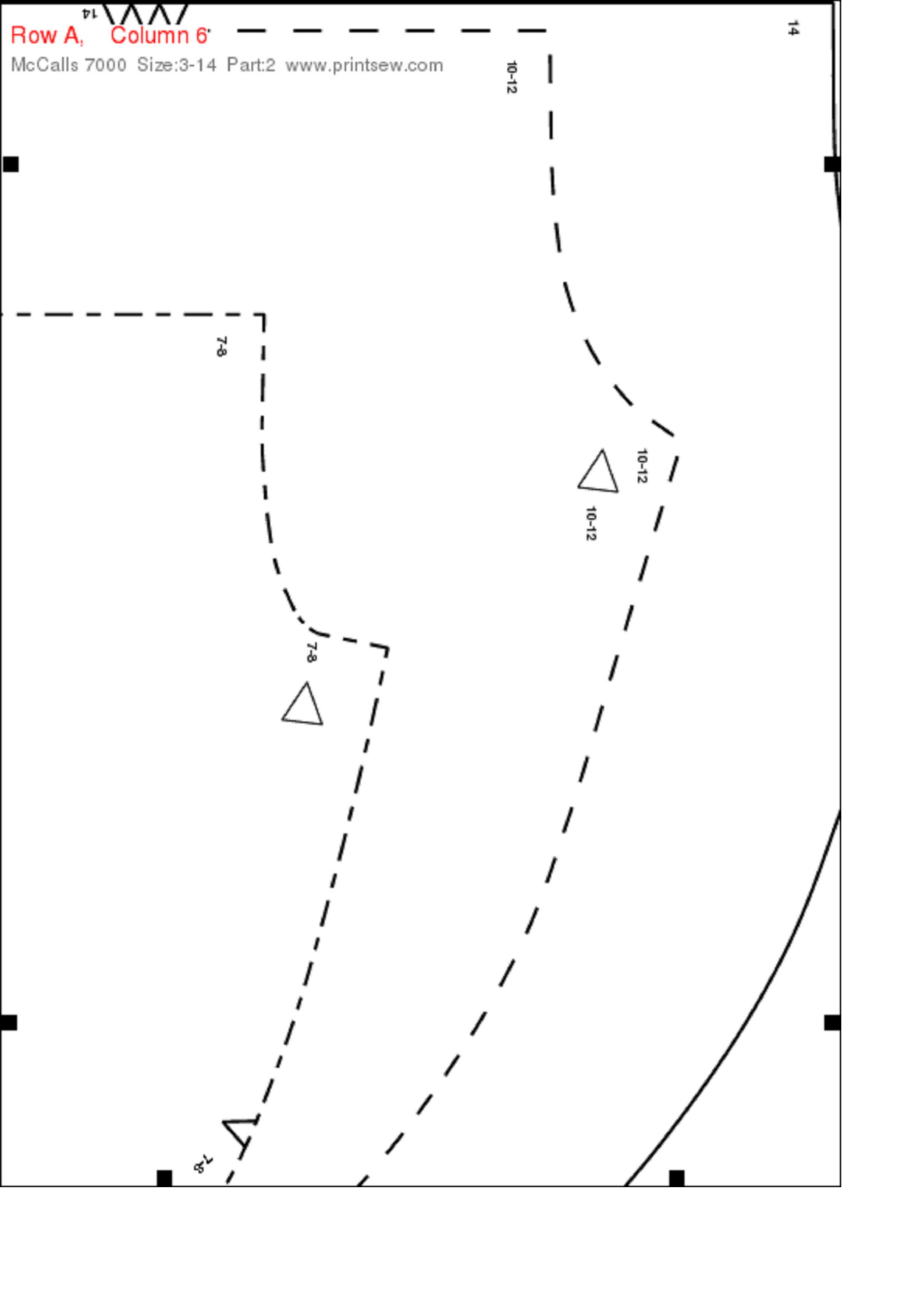

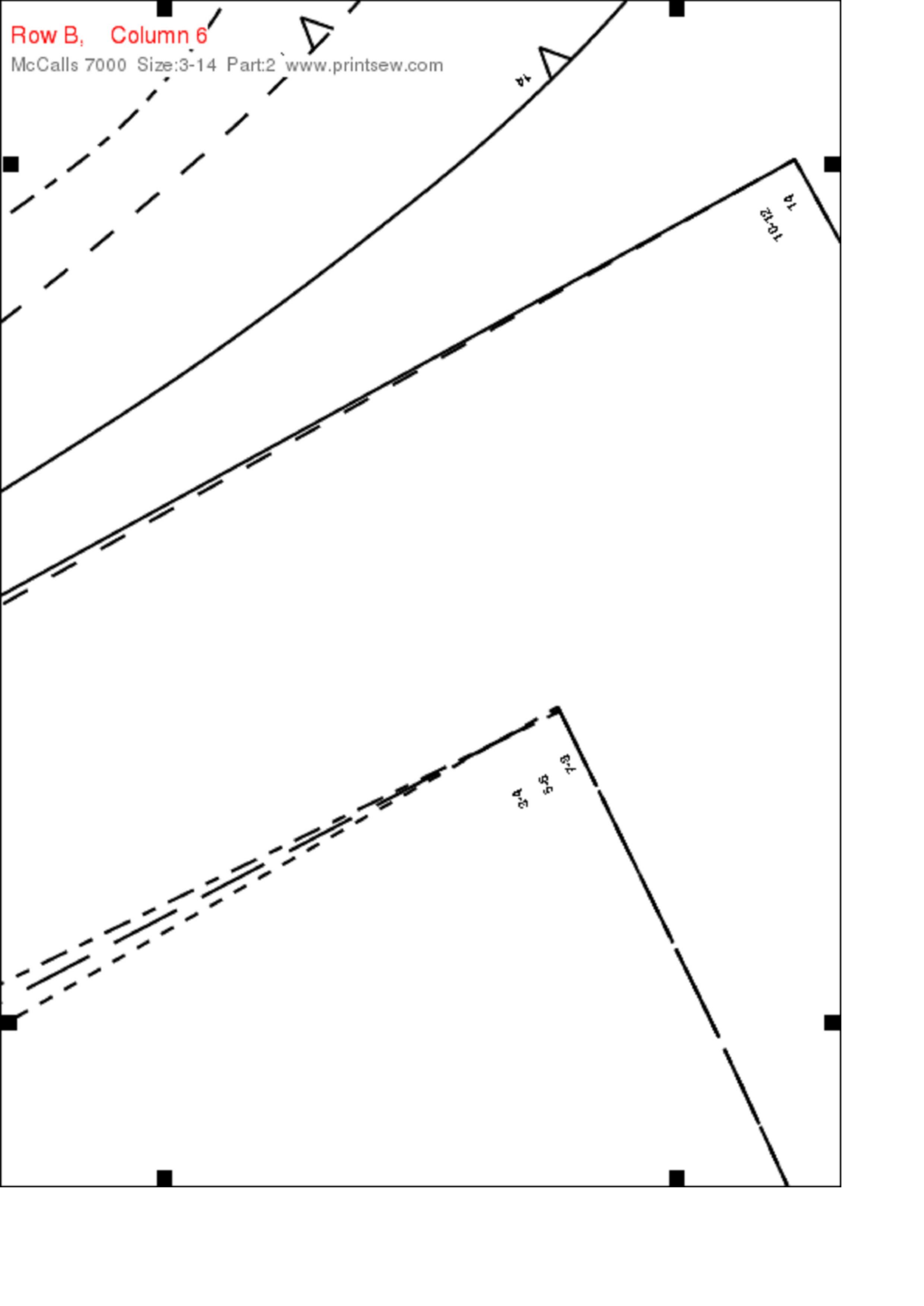

7-8

7-8





31.83E

 - Indique l'endroit où faire une couture de 15mm, sauf contre-indication.
 - Indique l'emplacement.
 - Indique l'emplacement.
 - Indique l'emplacement.
    - Indique l'emplacement pour faire les coutures et la construction.
 Les emplacements, et mieux, les constructions, si désiré, les

Row D, Column 6
McCalls 7000 Size:3-14 Part:2 www.printsew.com

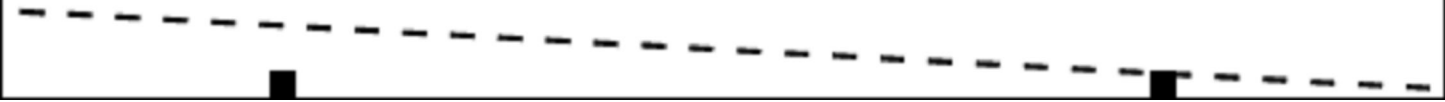
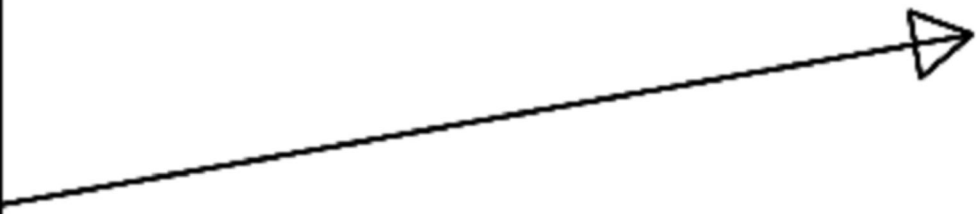

10-12

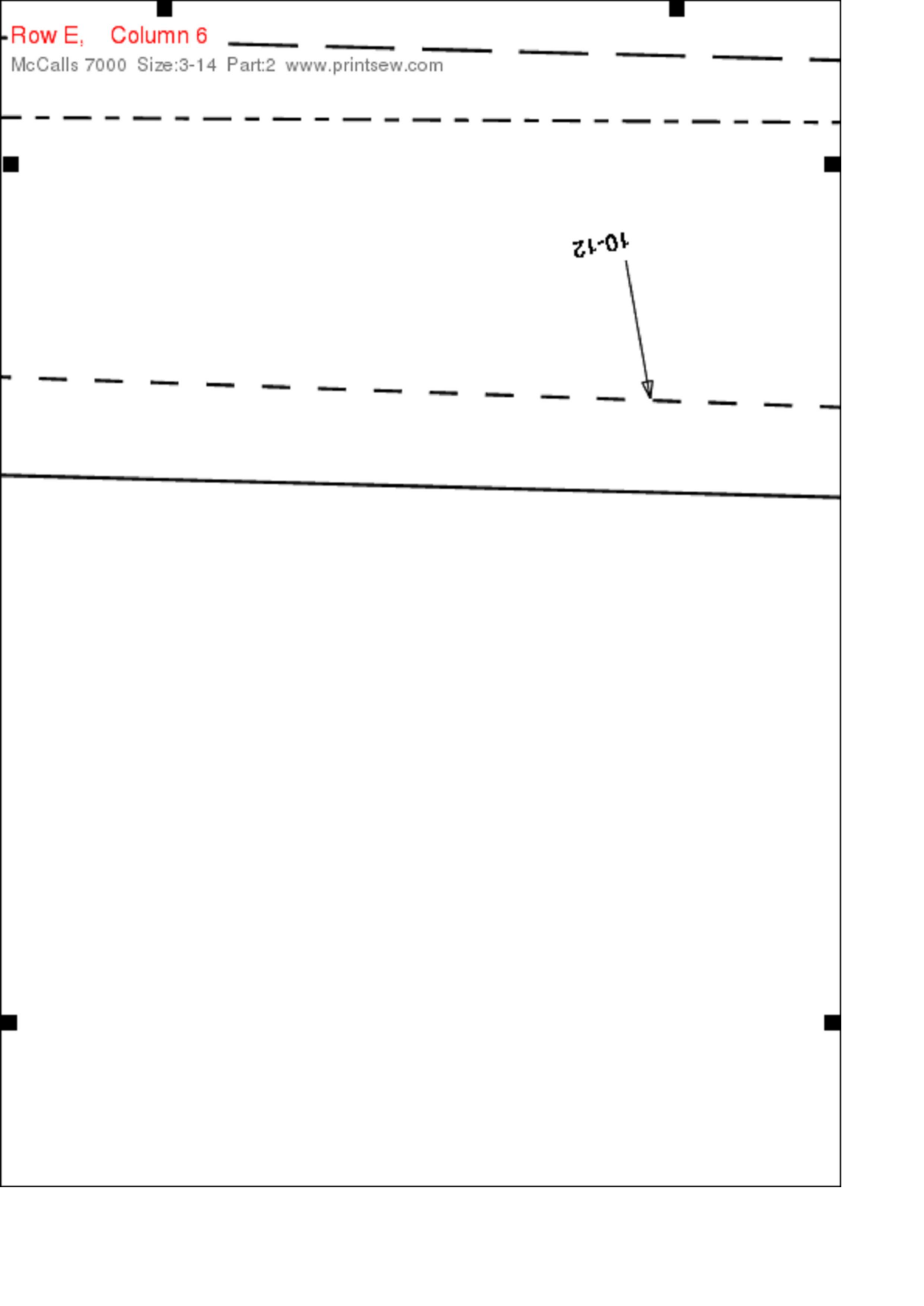

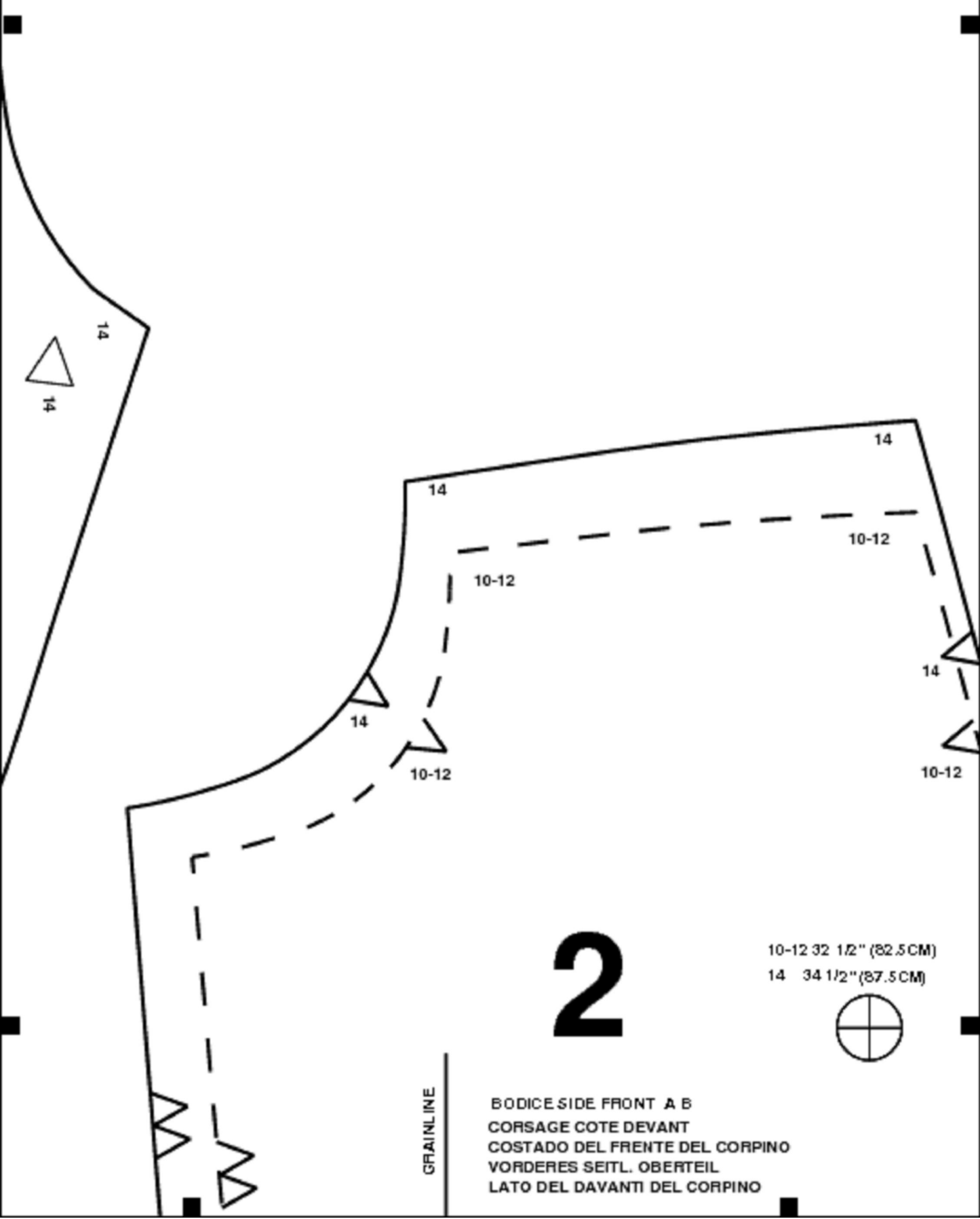

2

10-12 32 1/2" (82.5CM)

14 34 1/2" (87.5CM)



GRAINLINE

BODICE SIDE FRONT A B
CORSAGE COTE DEVANT
COSTADO DEL FRENTE DEL CORPINO
VORDERES SEITL. OBERTEIL
LATO DEL DAVANTI DEL CORPINO

Contrast 1: Cut 2

Lining: Cut 2

Row B, Column 7

McCalls 7000 Size:3-14 Part:2 www.printsew.com

McCALL'S M7000

Kids size (10-12) (14)

10-12

14

LENGTHEN OR SHORTEN HERE

CENTER BACK ON FOLD

19

KRAGEN
COLLETTA

Fabric: Cut 2 on fold
INTERFACING Cut 1 on fold

Kids size (3-4) (5-6) (7-

M7000



3-4

5-6

HERE

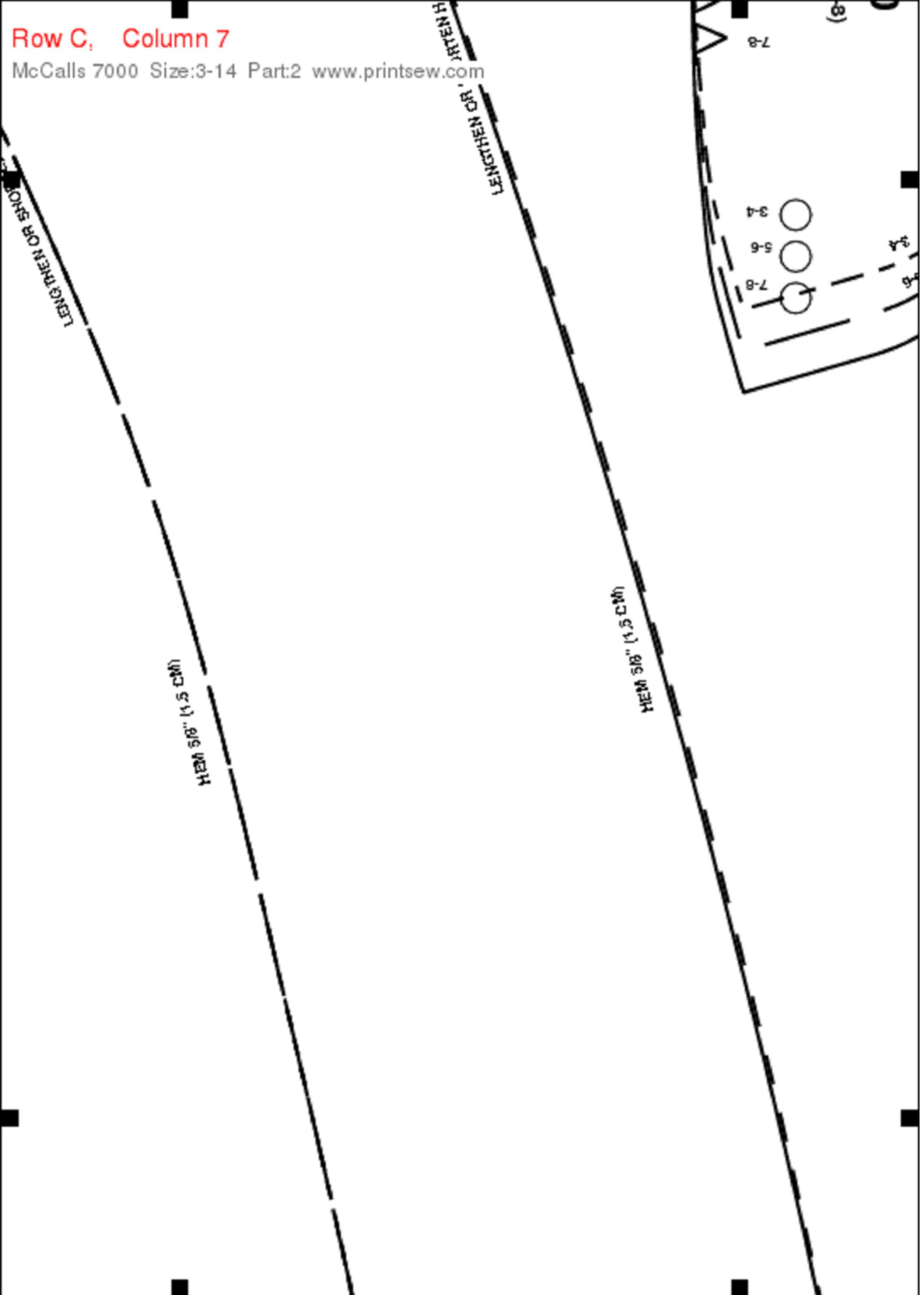

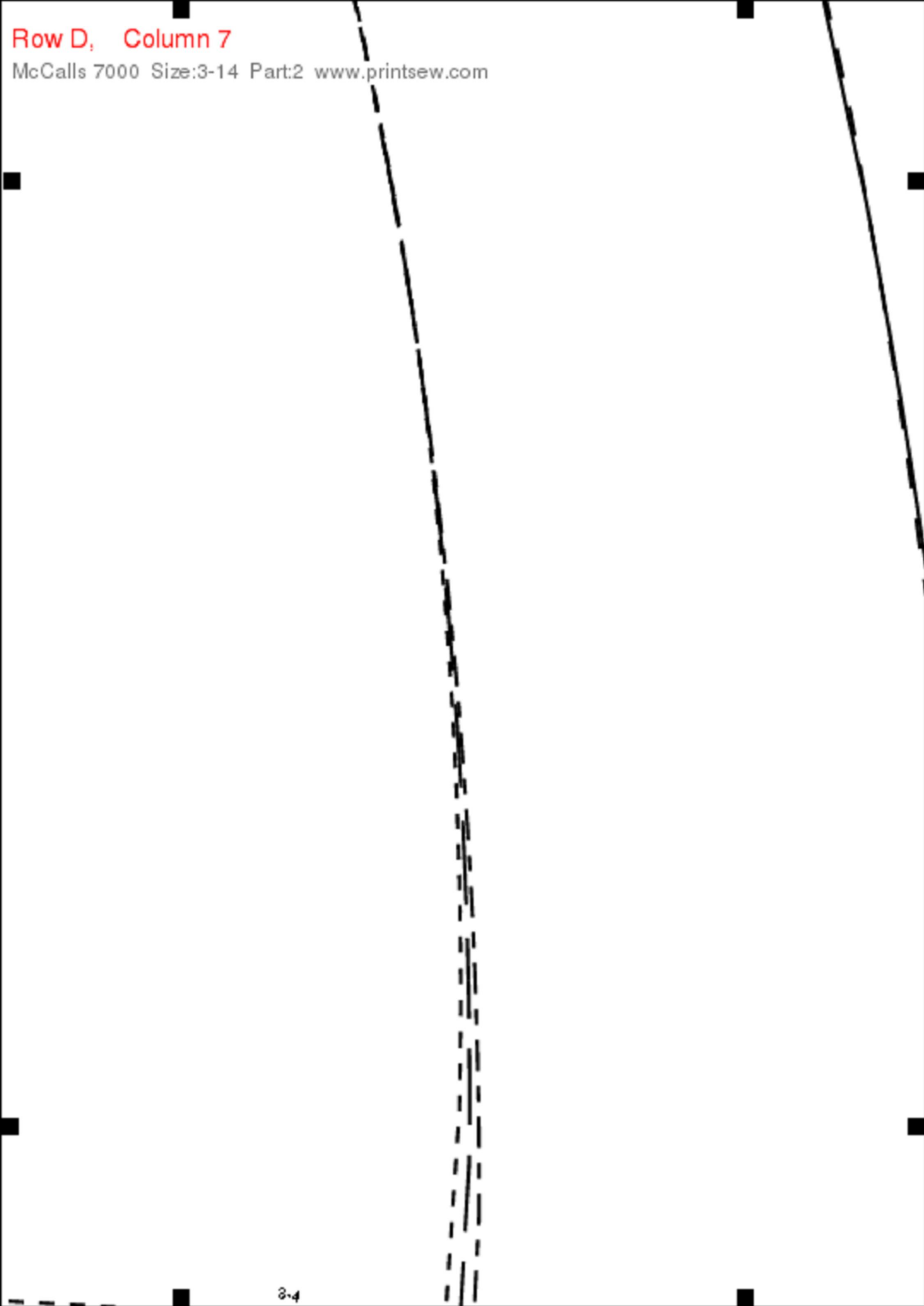

Row E, Column 7

McCalls 7000 Size:3-14 Part:2 www.printsew.com

7.8

14

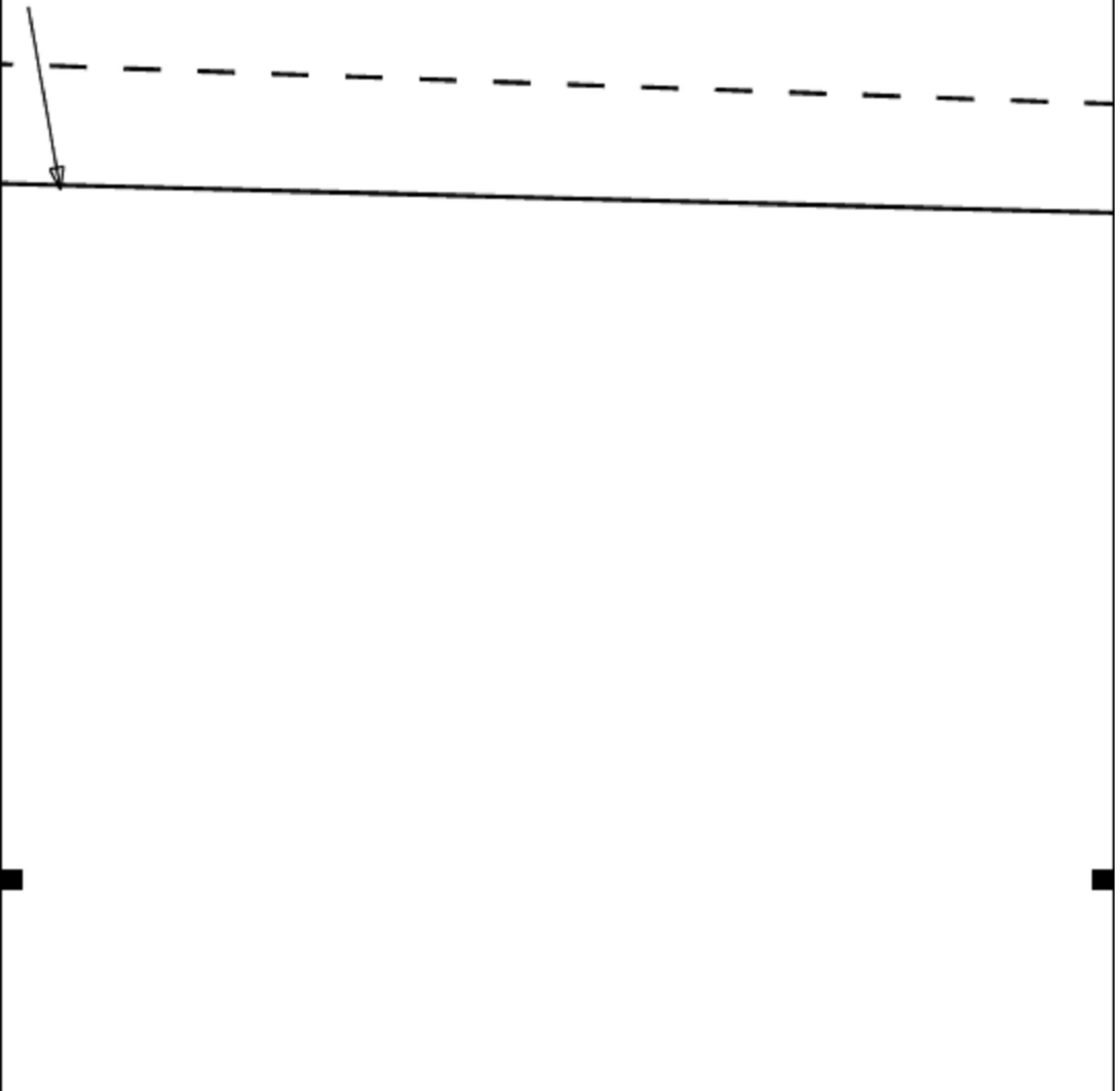

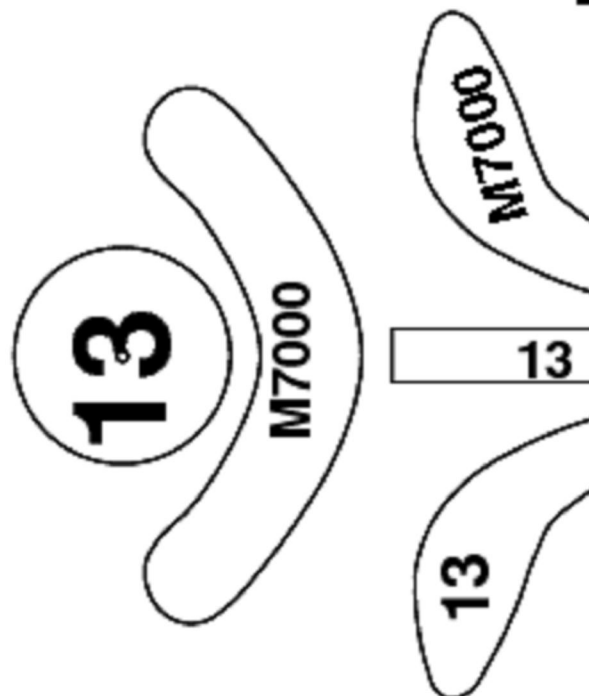
<p>13</p> <p>McCALL'S M7000 Kids size (10-12) (14)</p> <p>APPLIQUE A APPLIQUE APLICACION APPLIKATION APPLICAZIONE</p> <p>Fabric: Cut 9 Webbing - Cut 9</p> <p>SEE SEWING INSTRUCTIONS BEFORE YOU CUT VOIR TECHNIQUE D'EXECUTION AVANT DE COUPER VEA LAS INSTRUCCIONES DE LA COSTURA ANTES DE CORTAR SIEHE NAHANLEITUNG VOR DEM ZUSCHNEIDEN LEGGERE LE ISTRUZIONI PER LA CUCITURA PRIMA DI TAGLIARE</p>	 <p>The image shows three pieces of a cutting pattern. The largest piece is a curved, teardrop shape with a circular hole in the center, labeled '13' and 'M7000'. To its right is a rectangular piece labeled '13'. Below the rectangular piece is a smaller curved piece, also labeled '13' and 'M7000'. The pieces are arranged on a grid with small black squares at the corners.</p>
---	---

COLLAR C
COL
CUELLO



McCALL

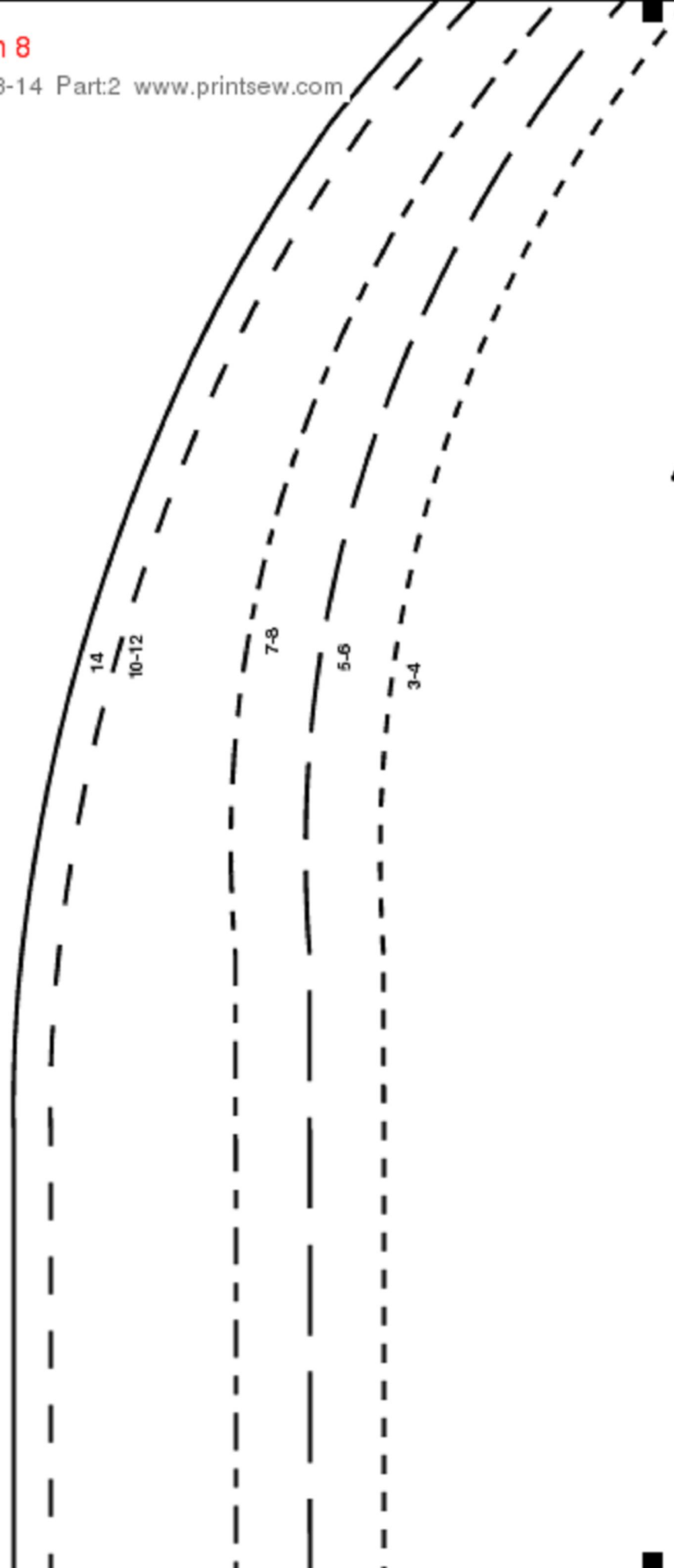

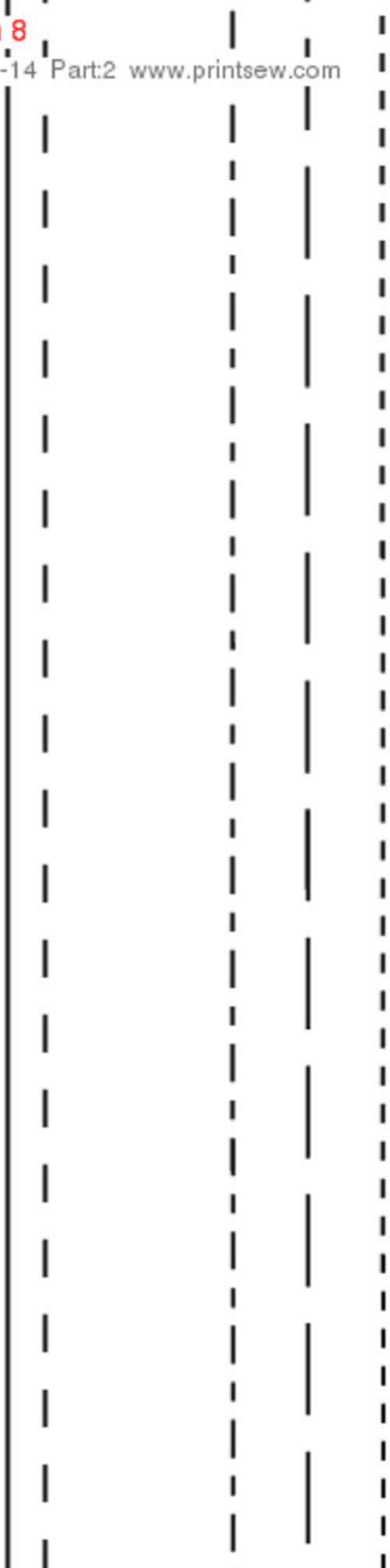

CENTER FRONT 3-4

GRAINLINE

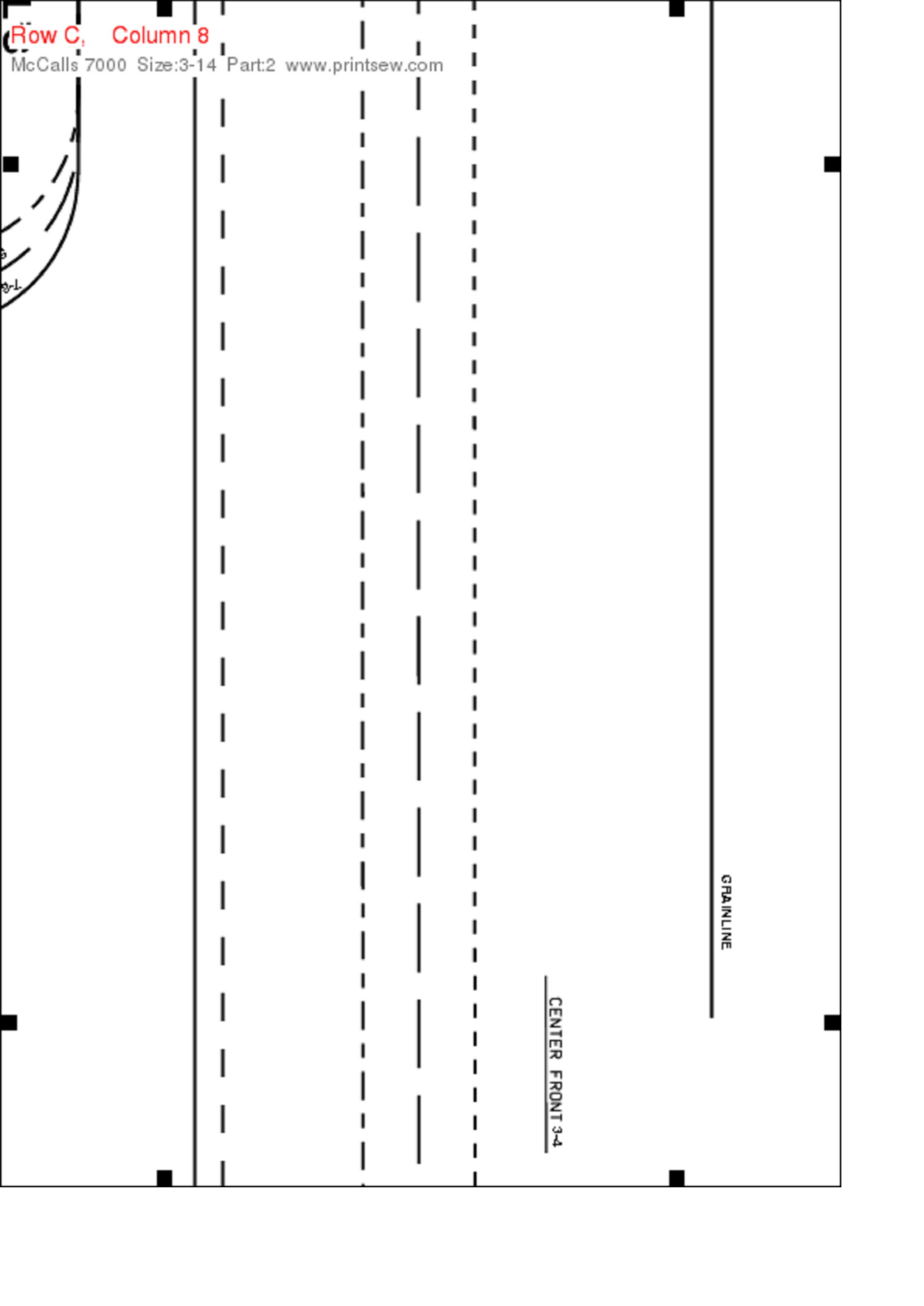

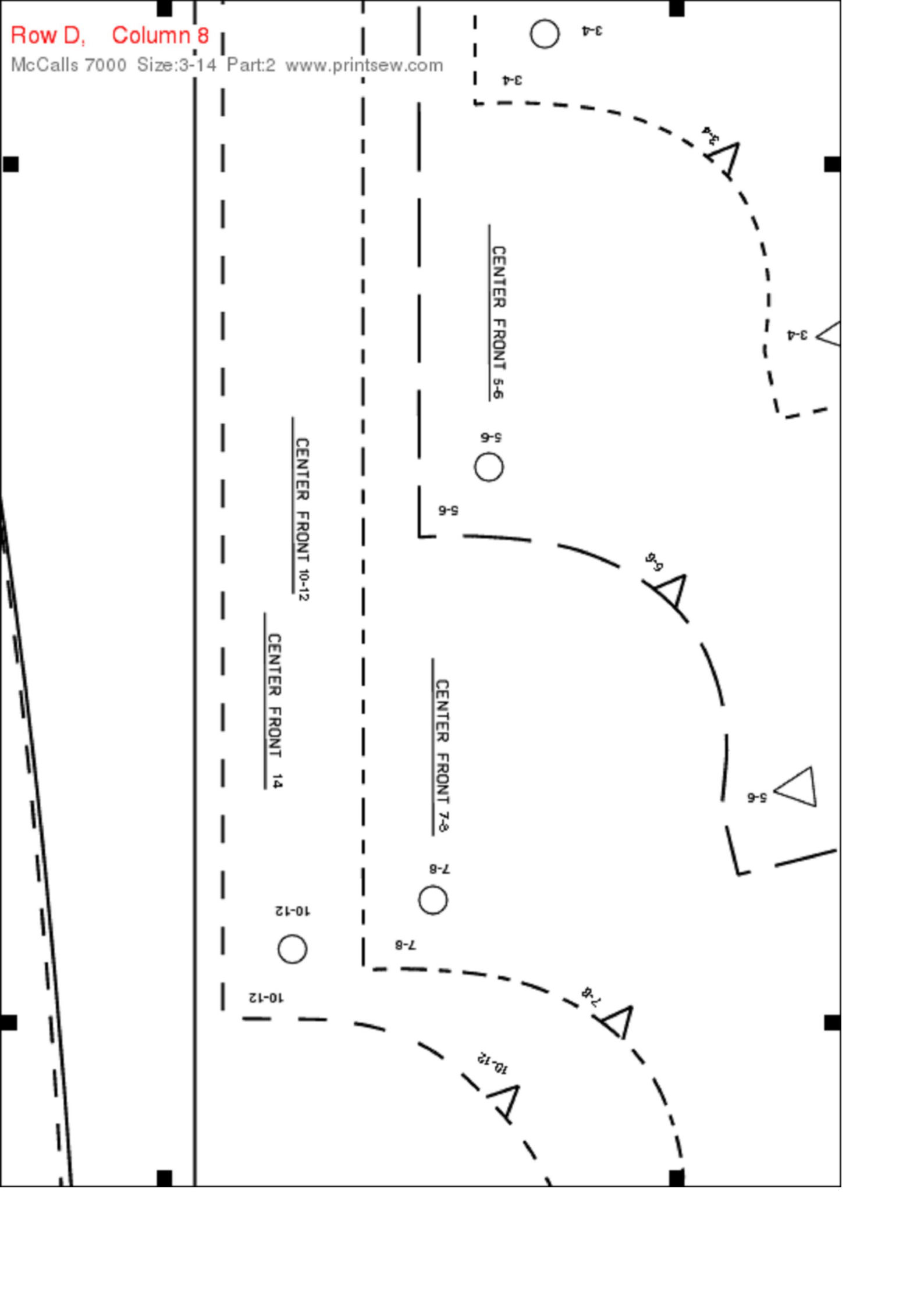

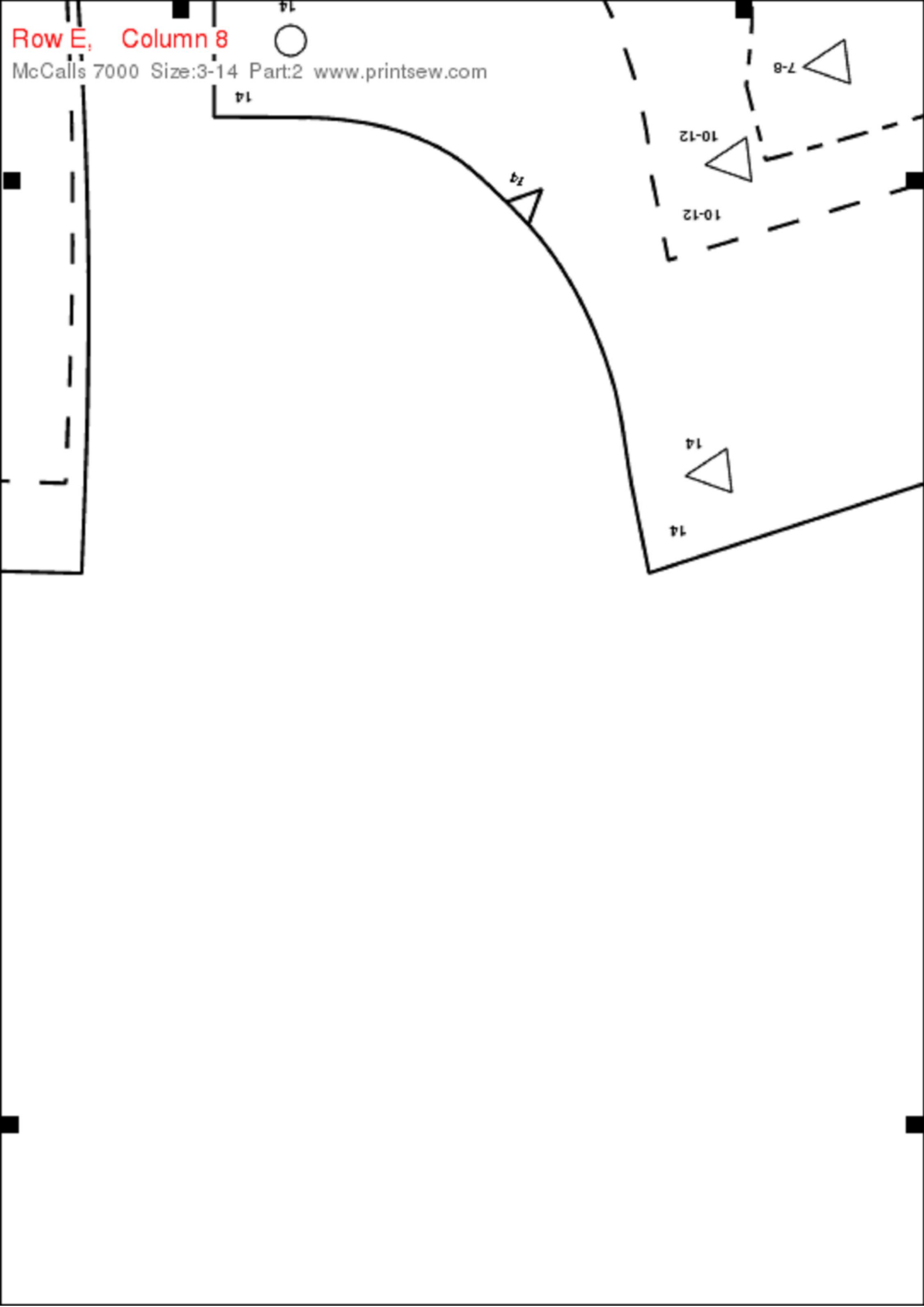

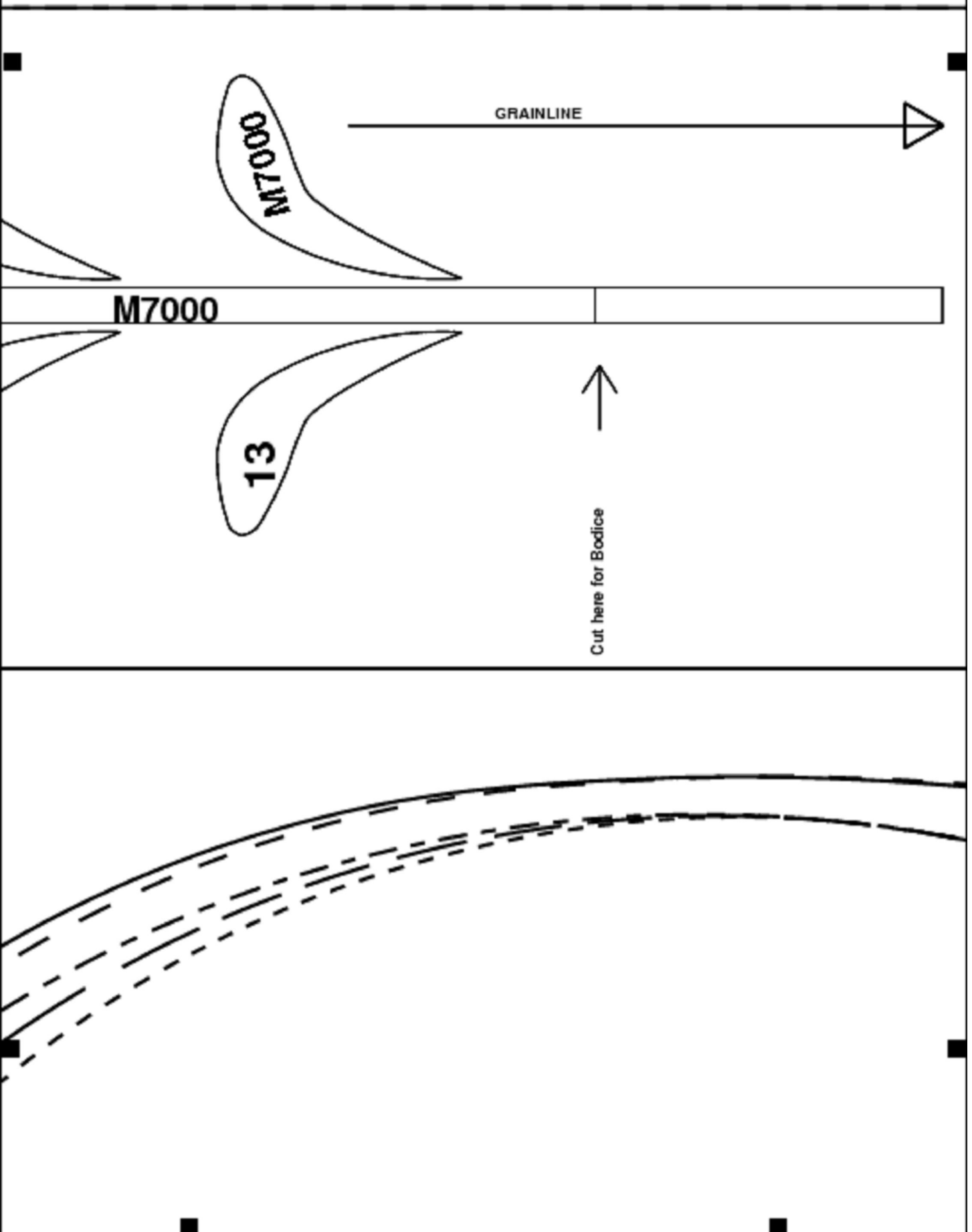

McCALL'S
M7000
Kids size (3-4) (5-6) (7-8) (10-12) (14)

Lining: Cut 2

Fabric: Cut 2

DEVANT
FRENTE
VORDERTEIL
DAVANTI

FRONT C

16

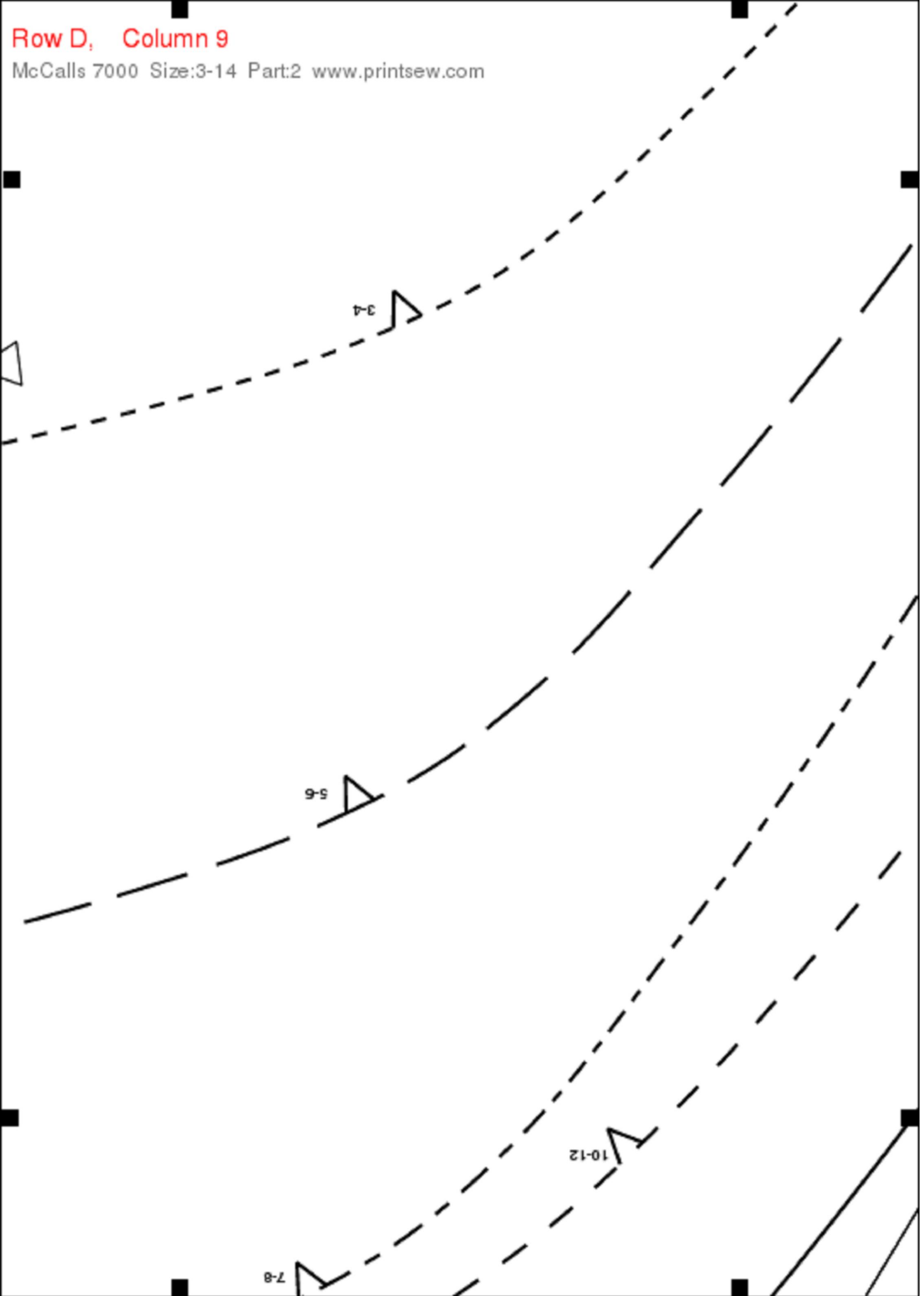

Row E, Column 9

McCalls 7000 Size:3-14 Part:2 www.printsew.com

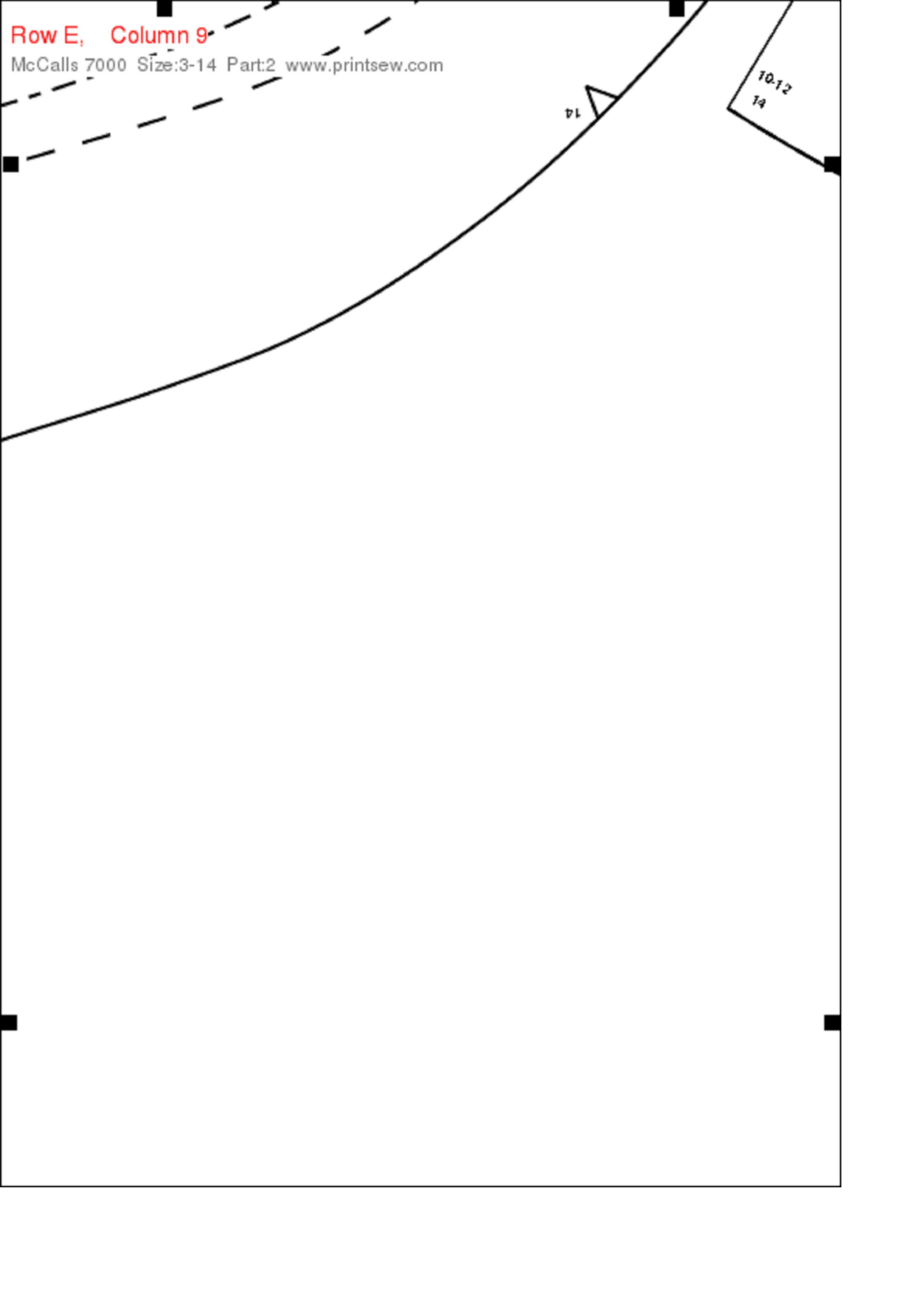

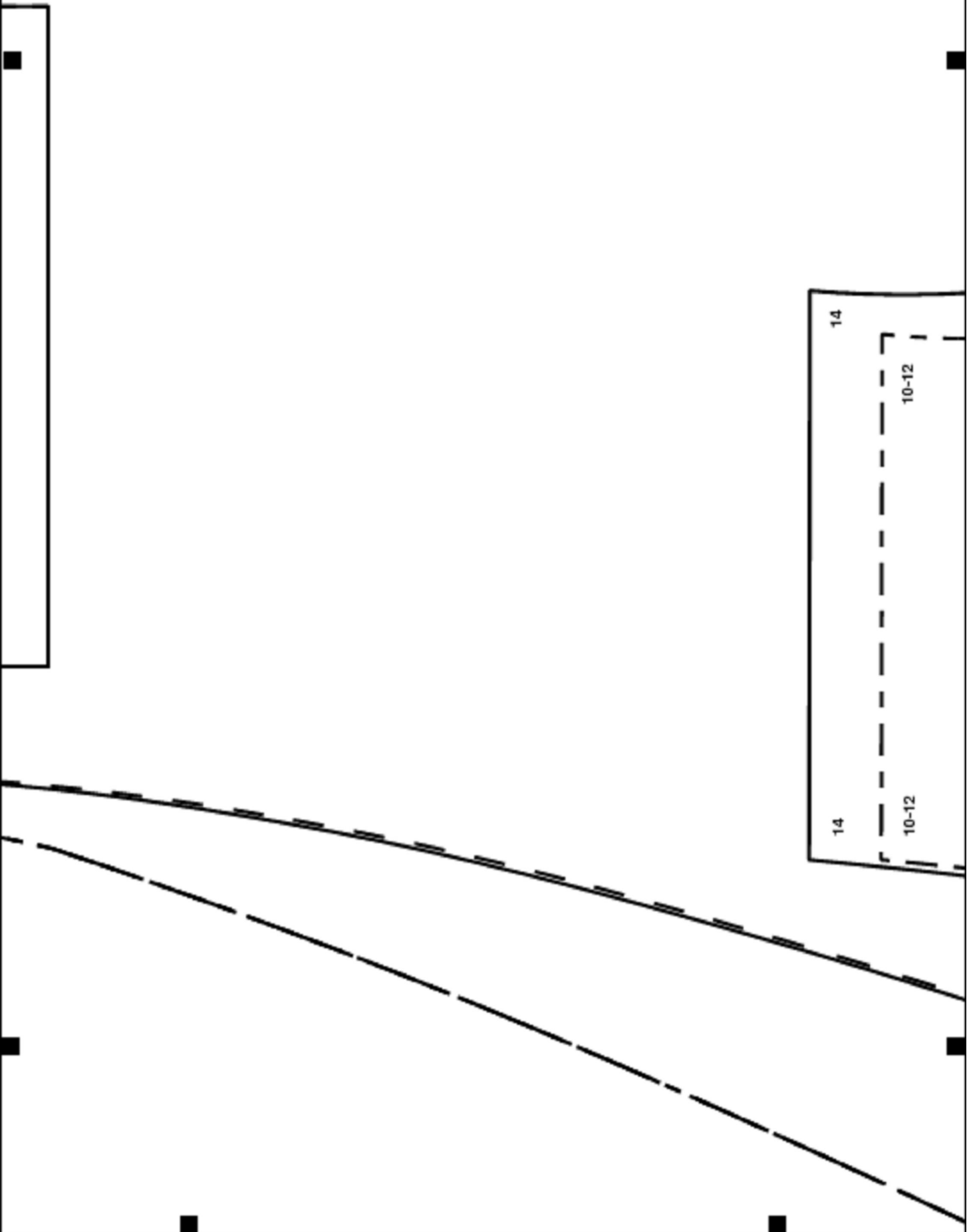

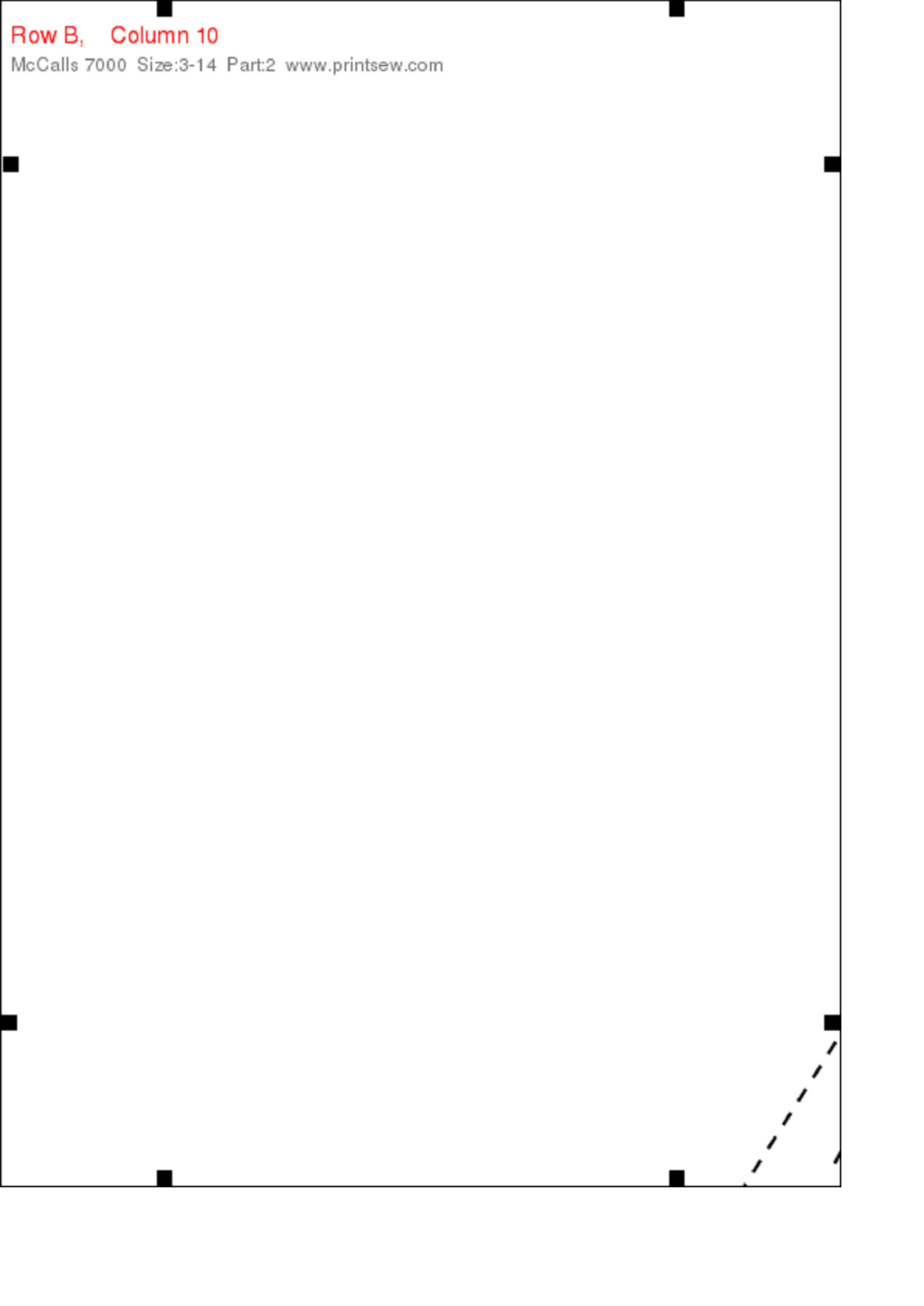

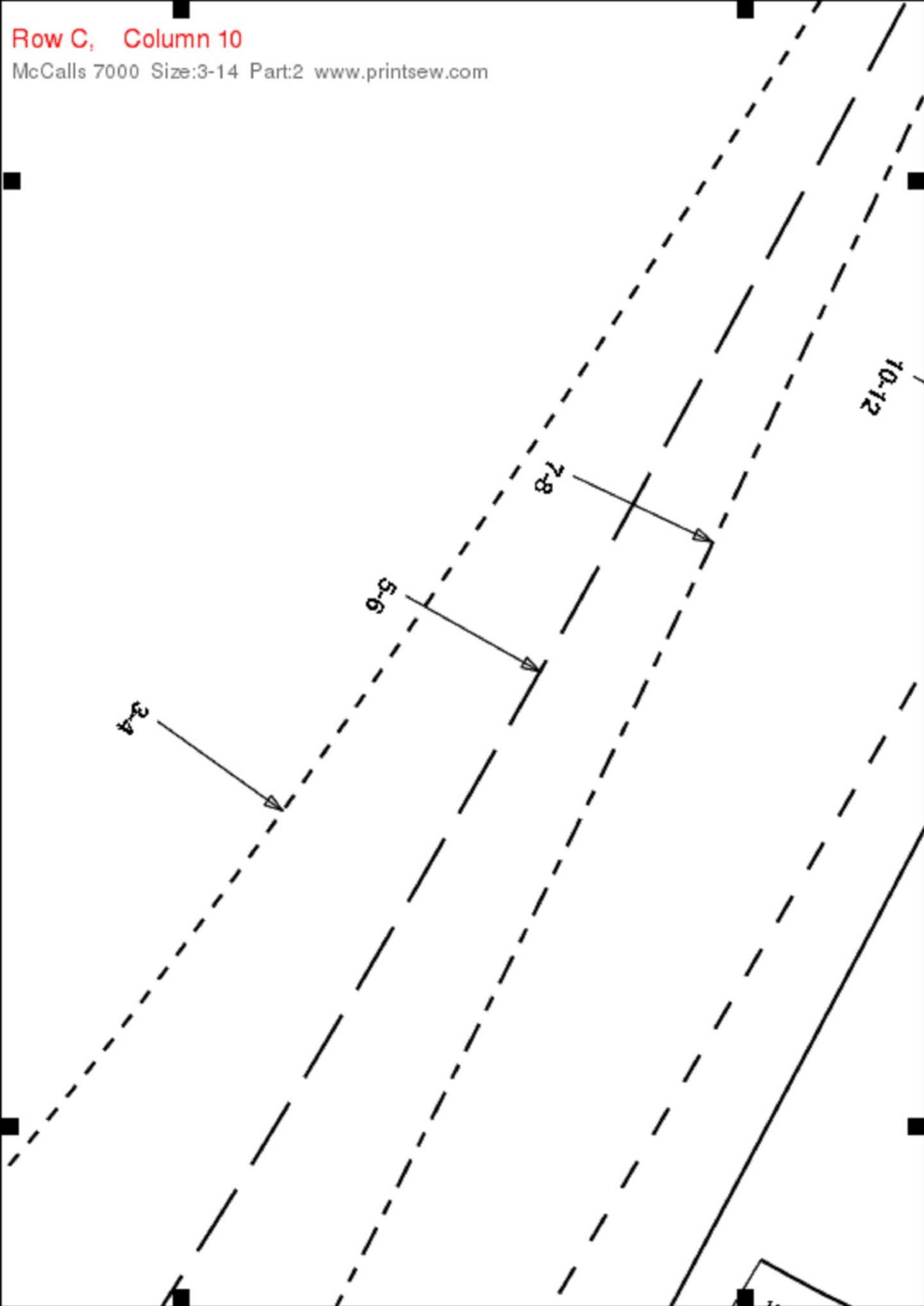

18

CAPELET BACK C

CAPE DOS
ESPALDA DE LA CAPA
RÜCKW. CAPETEIL
DIETRO DELLA CAPPÀ

Fabric: Cut 1 on fold
Lining: Cut 1 on fold

MCCALL'S
M7000

Kids size (3-4) (5-8) (7-8) (10-12) (14)

CENTER BACK ON FOLD

CENTER BACK ON FOLD

10-12

7-8

5-8

3-4

3-4

3-4
5-8
7-8

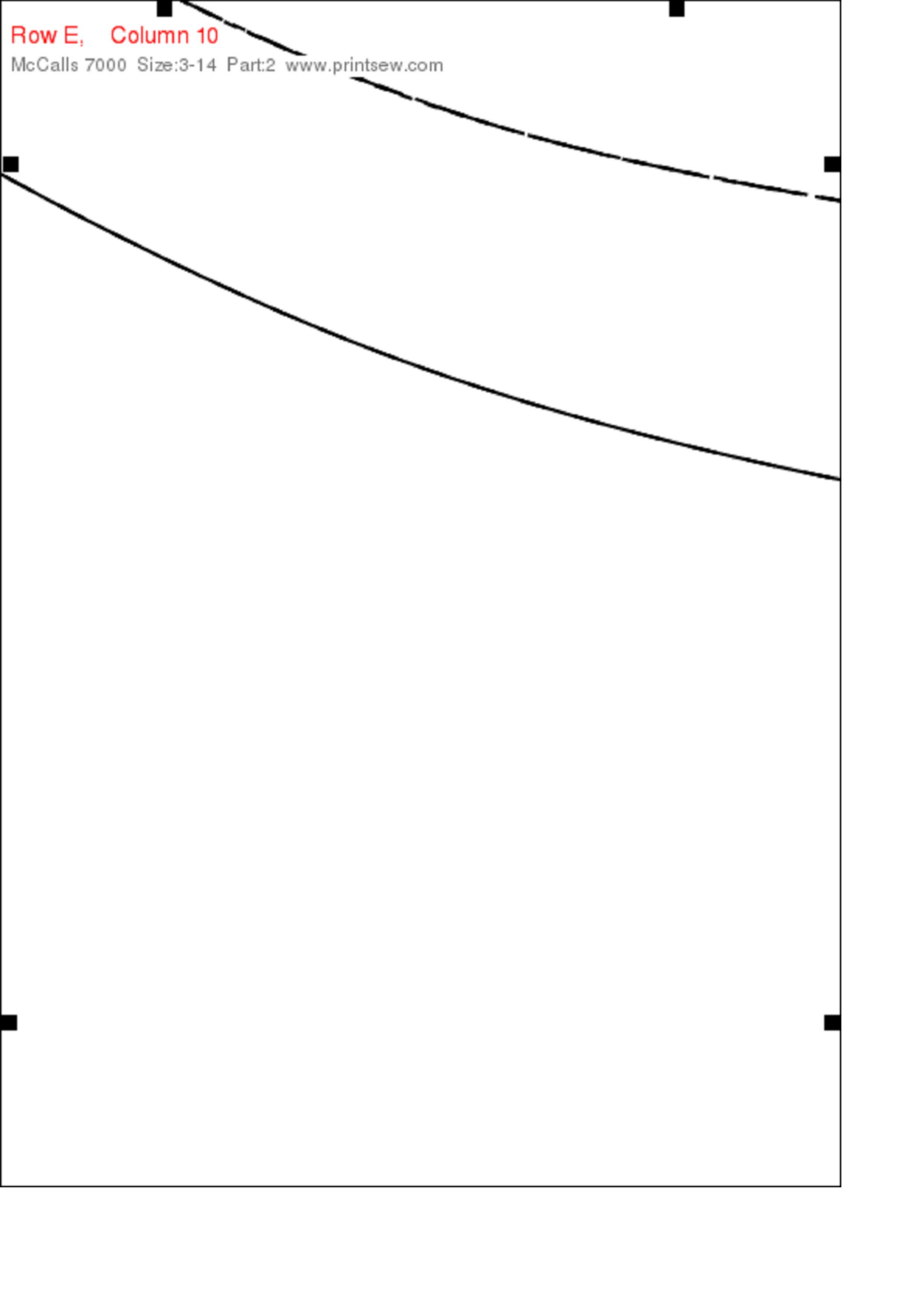

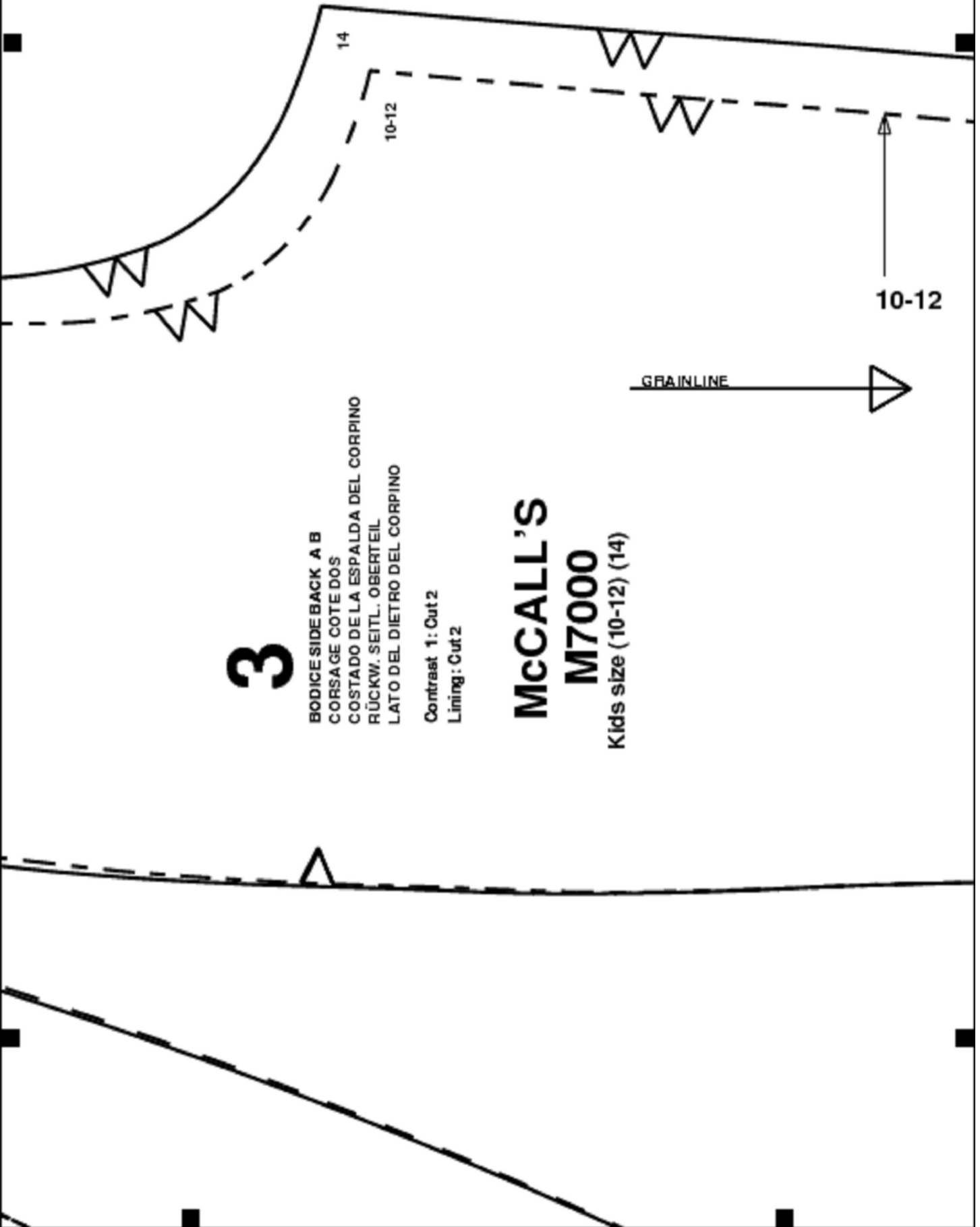

3

BODICE SIDE BACK A B
CORSAGE COTEDOS
COSTADO DE LA ESPALDA DEL CORPINO
RÜCKW. SEITL. OBERTEIL
LATO DEL DIETRO DEL CORPINO

Contrast 1: Cut 2

Lining: Cut 2

MCCALL'S

M7000

Kids size (10-12) (14)

GRAINLINE

10-12

14

10-12

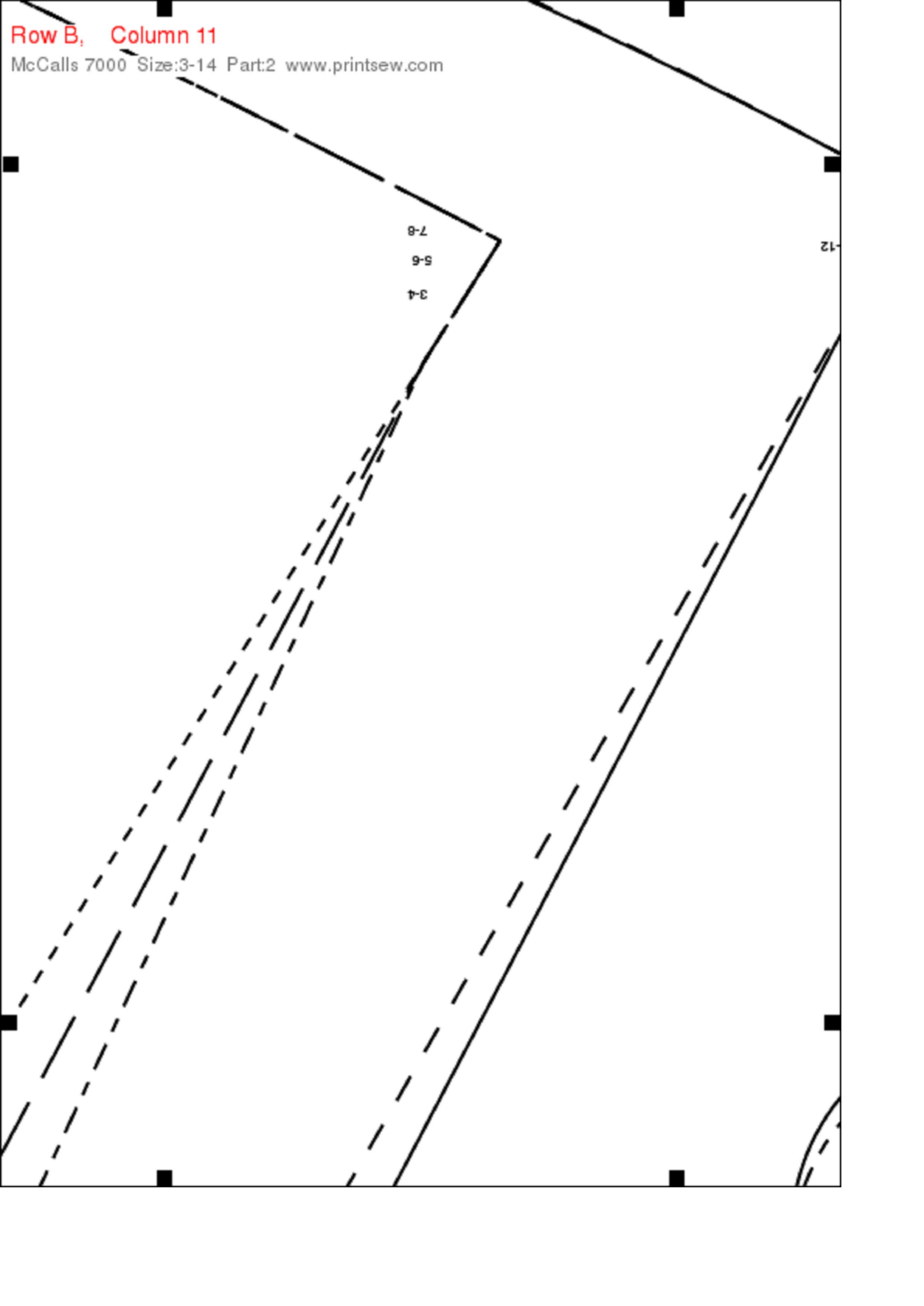

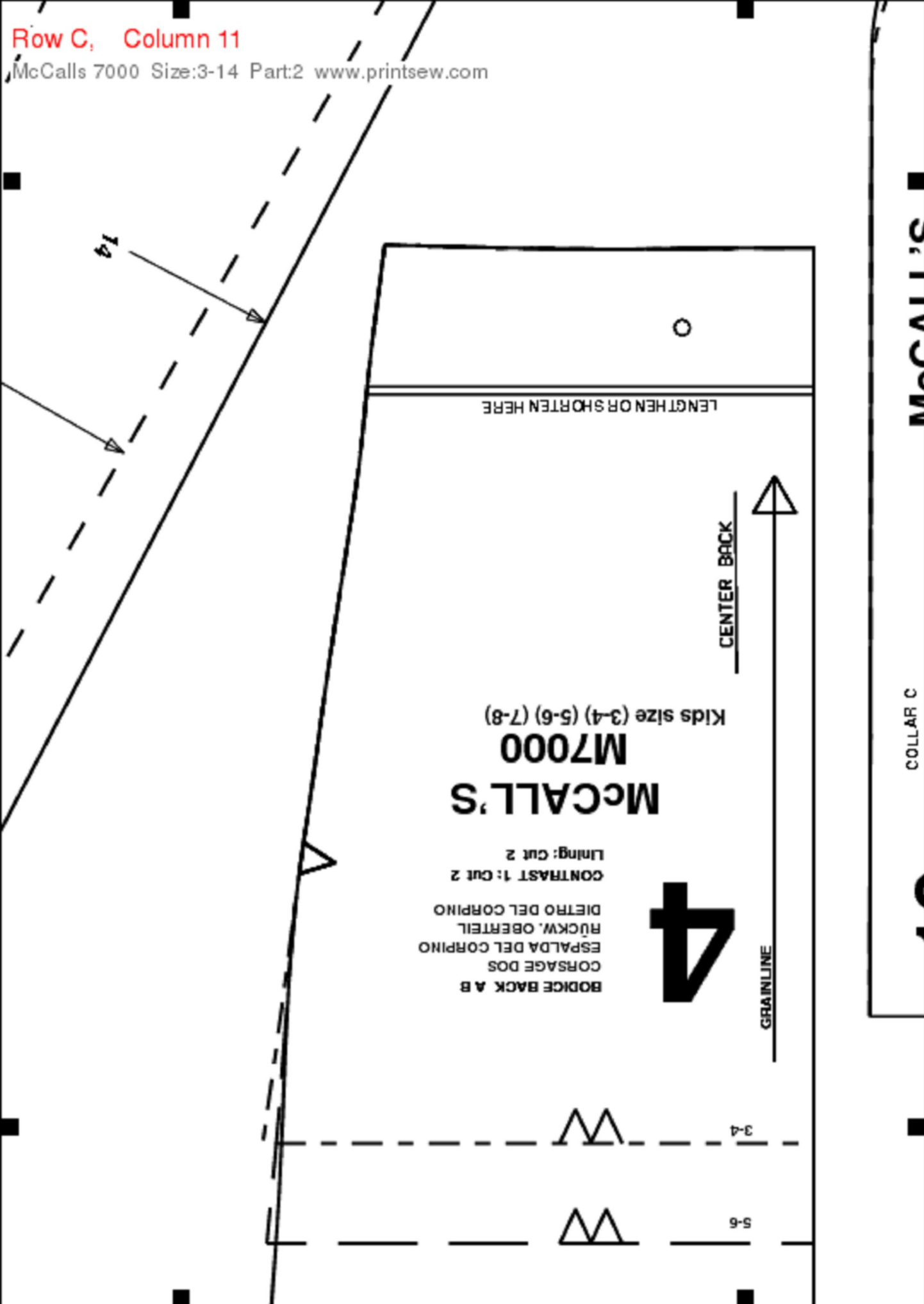

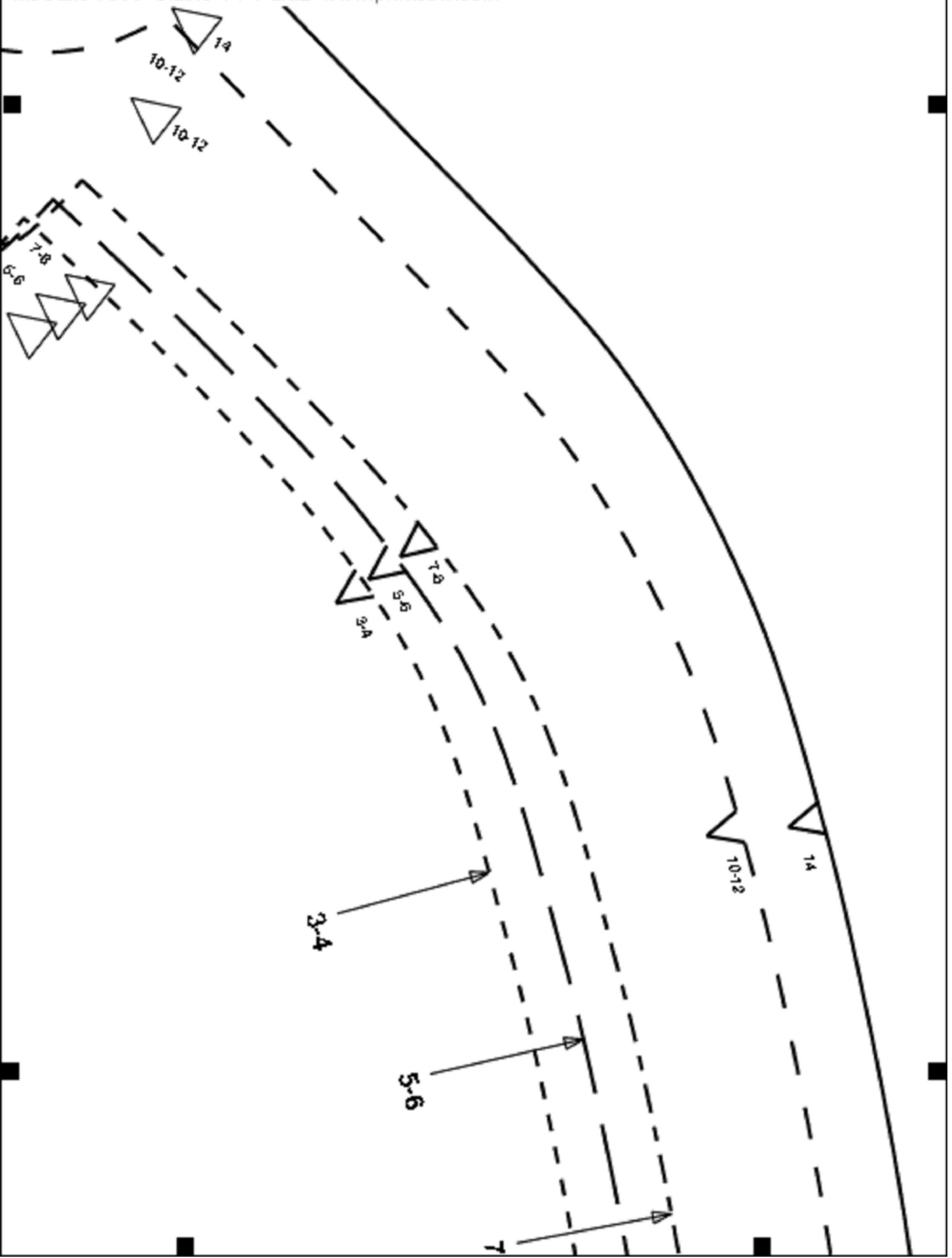

8

10-12

1A

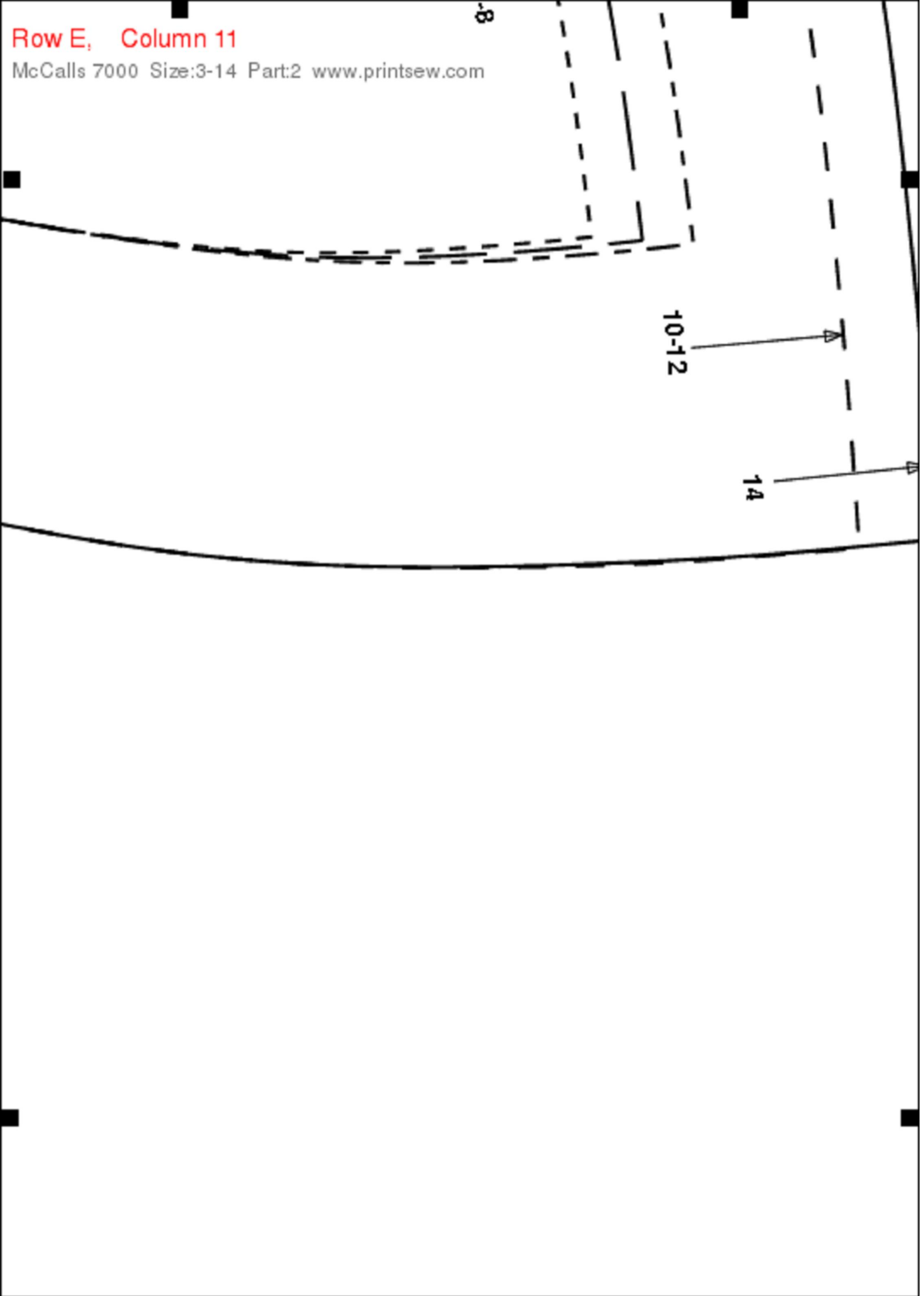

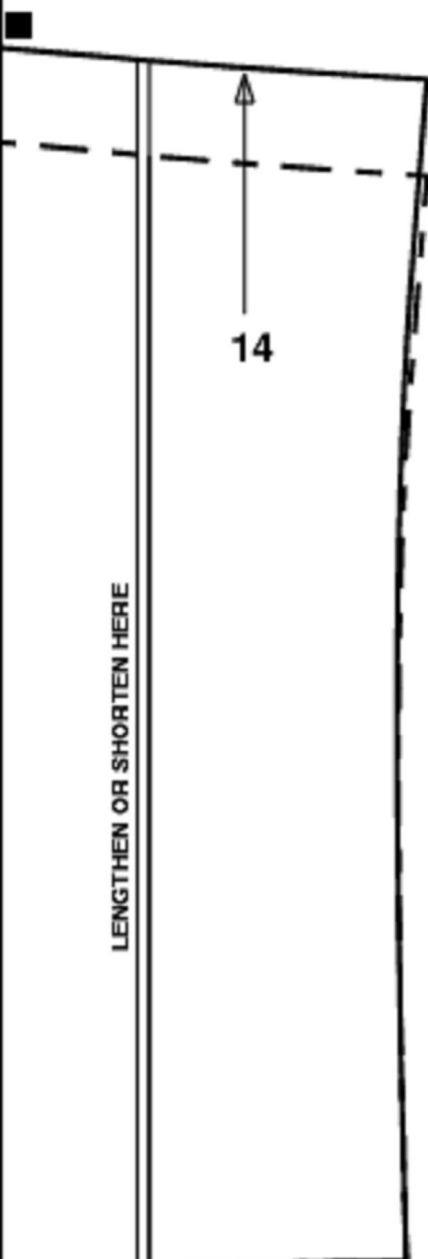

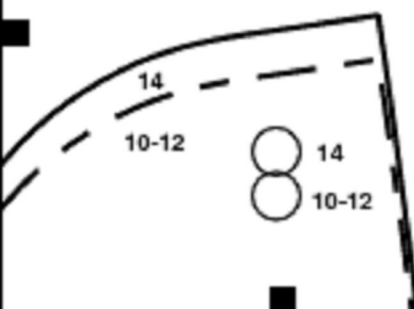
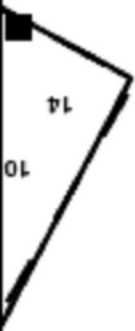

MCCALLS

M7000

Kids size (10-12) (14)

COL
CUELLO
KRAGEN
COLLETO

Fabrics: Cut 2 on fold
INTERFACING Cut 1 on fold

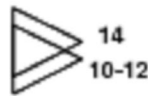
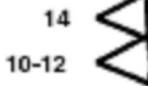

CENTER BACK ON FOLD

CENTER BACK 3-4	3-4	CENTER BACK 7-8	7-8
CENTER BACK 5-6	5-6	CENTER BACK 7-8	7-8

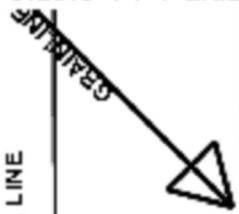

ROLL LINE

7-8
5-6
3-4



7-8
5-6
3-4



McCALL'S M7000

Kidss size (3-4) (5-6) (7-8)

CENTER FRONT

NECK FACING A B
PAREMENTURE D'ENCO LURE
VISTA DEL ESCOTE
HALS- A USSCHNITT BELAG
MOSTRA PER IL COLLO

CONTRAST 2: CUT 1

11

Row E, Column 12

McCall's 7000 Size:3-14 Part:2 www.printsew.com

