

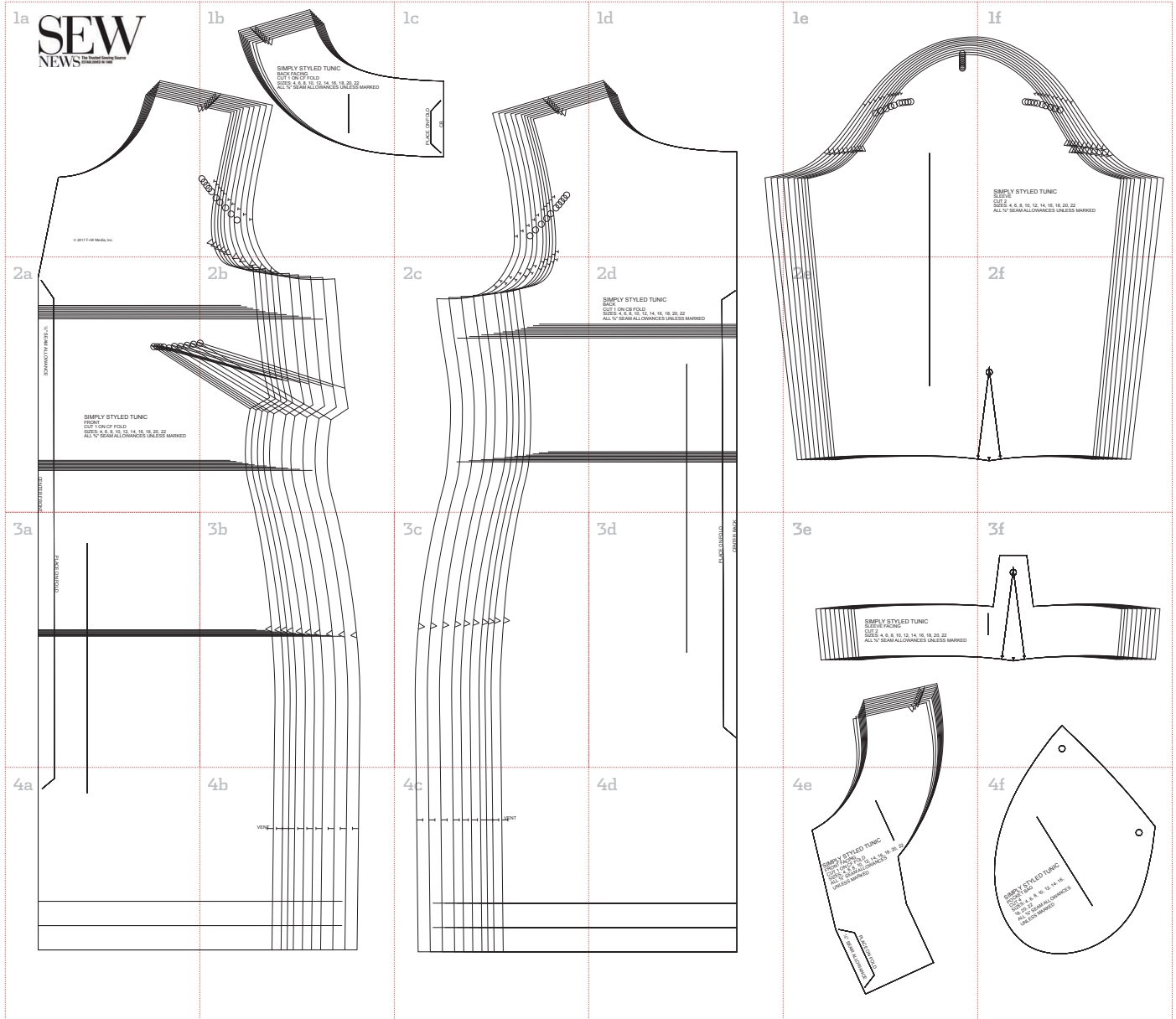

## Simply Styled Tunic ePattern Layout

24 pages: 1a-1f, 2a-2f, 3a-3f, 4a-4f

Print this page first at 100%, then measure the 2" test square before printing full pattern.

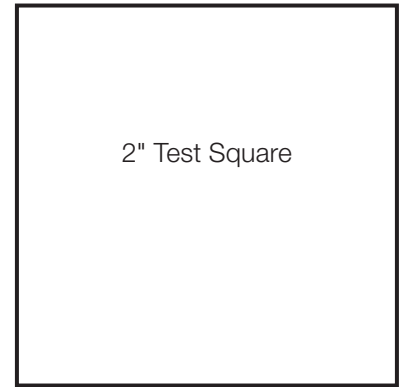

Measurements	4	6	8	10	12	14	16	18	20	22
BUST	33	34	35	36	37	39	40½	42½	44½	46½
WAIST	31½	32½	33½	34½	35½	37½	39	41	43	45
HIP	35⅝	37⅝	38⅝	39⅝	40⅝	42⅝	43⅝	45⅝	47⅝	49⅝

1a

# SEW

NEWS

The Trusted Sewing Source  
ESTABLISHED IN 1980

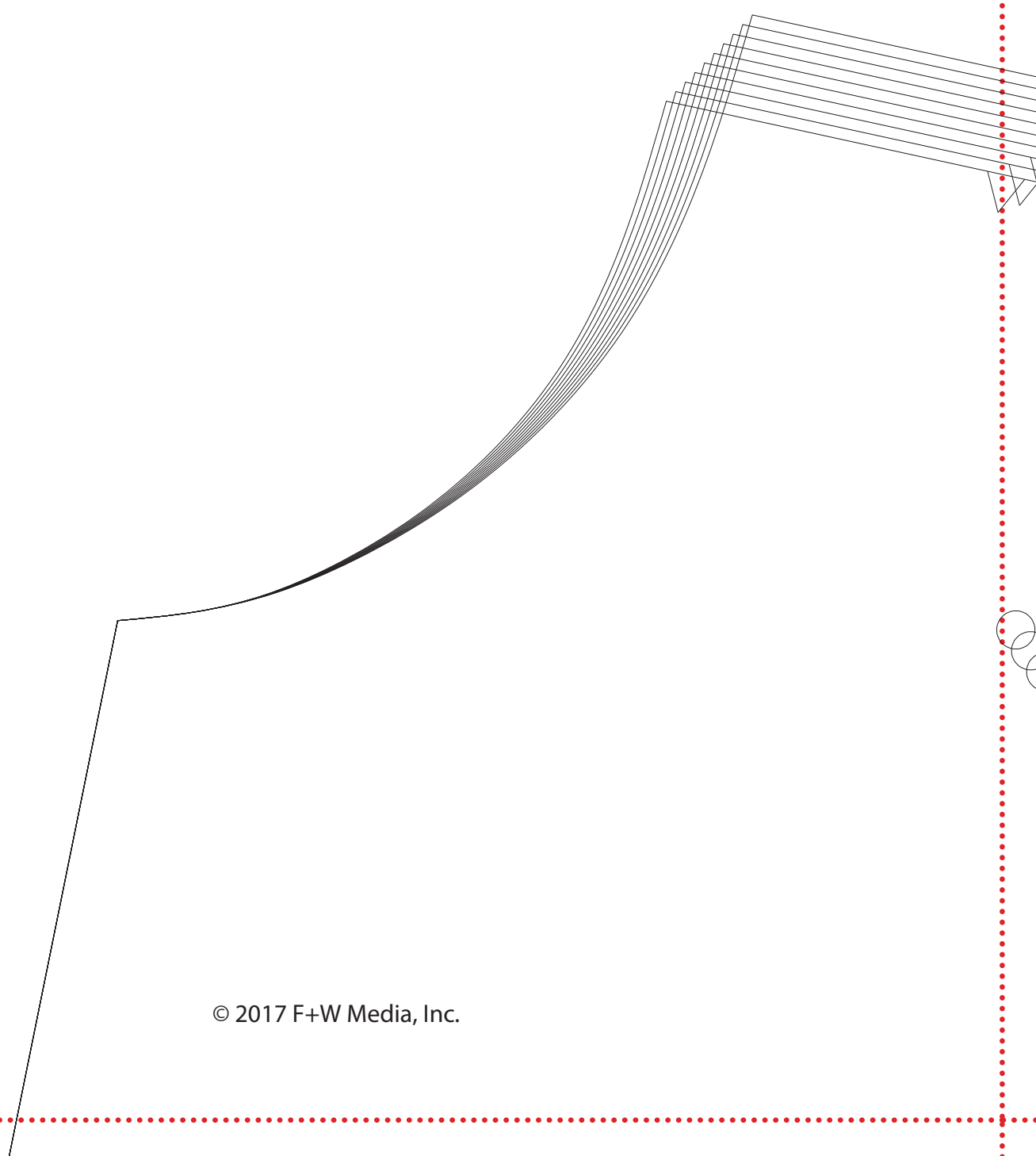

1b

**SIMPLY STYLED TUNIC**

**BACK FACING**

**CUT 1 ON CF FOLD**

**SIZES: 4, 6, 8, 10, 12, 14, 16, 18, 20, 22**

**ALL  $\frac{5}{8}$ " SEAM ALLOWANCES UNLESS MARKED**

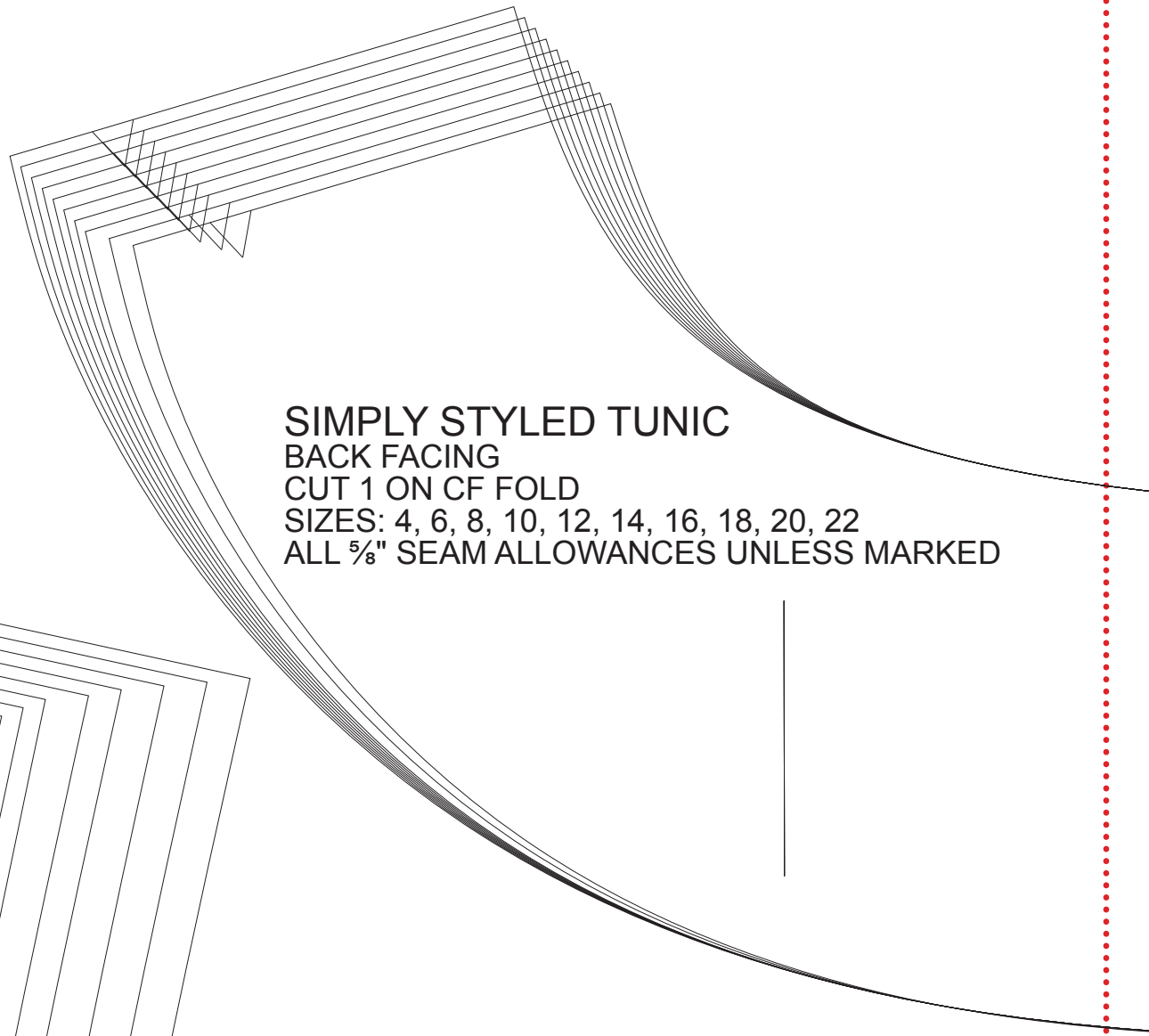
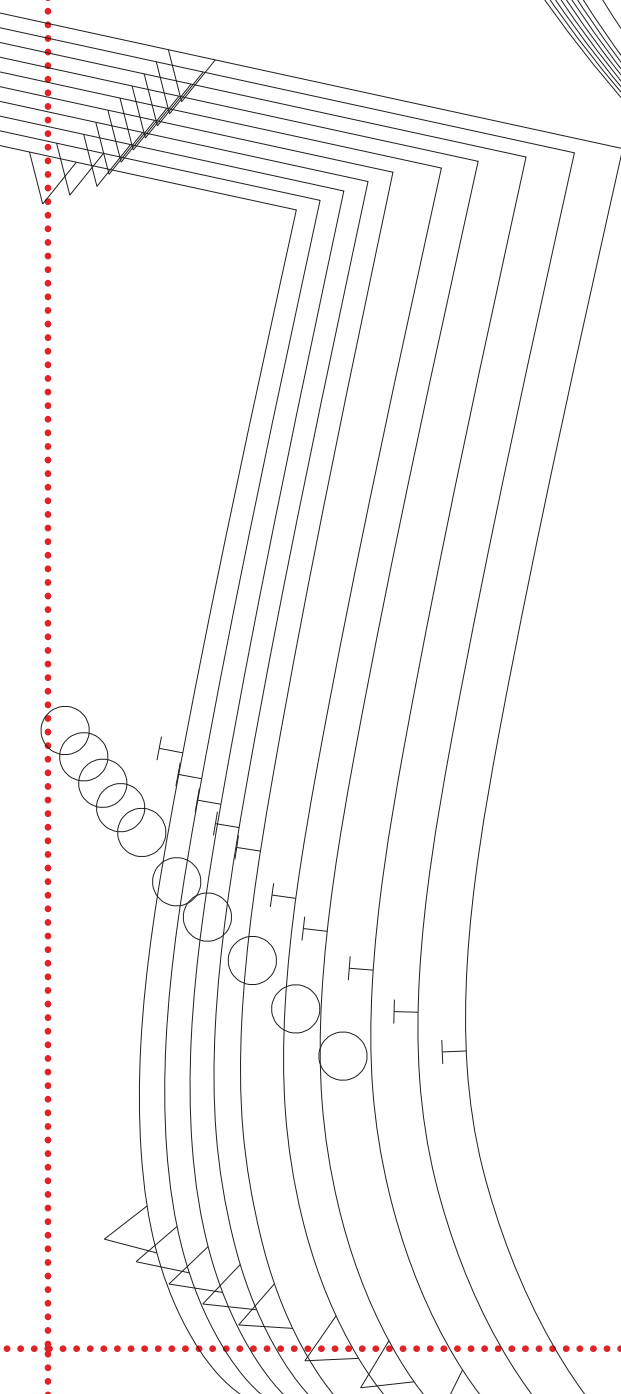

1c

PLACE ON FOLD

CB

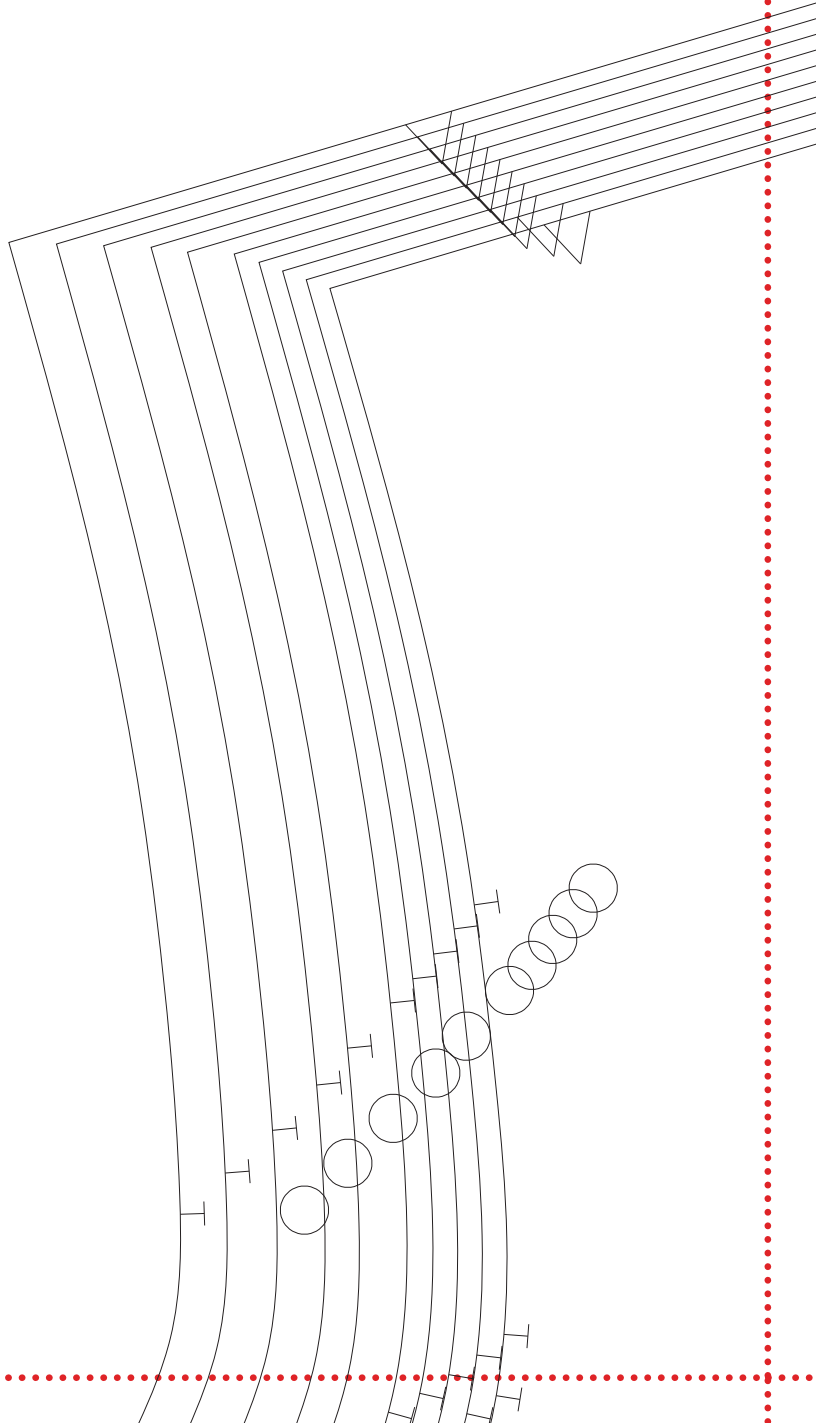

1d

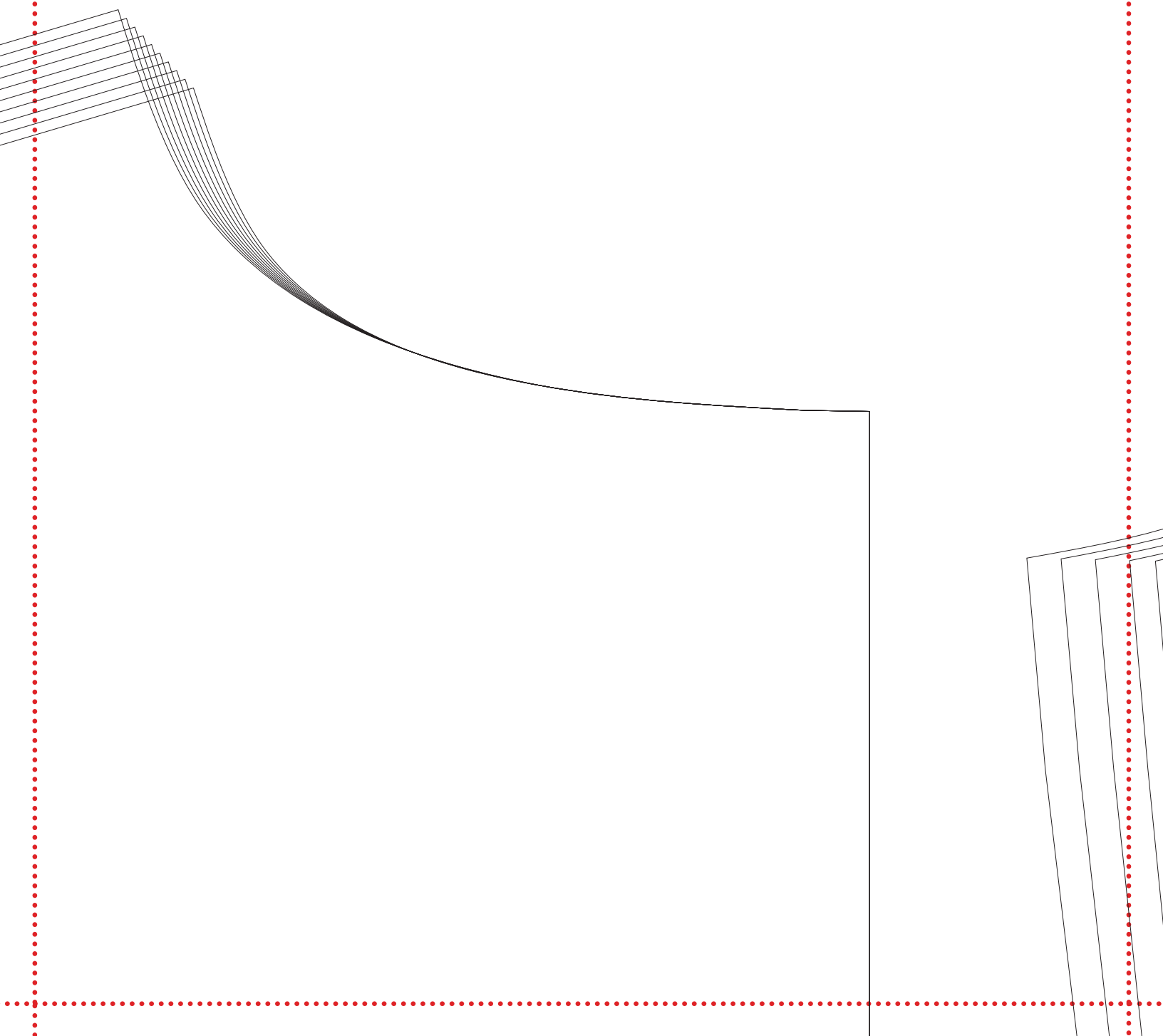

1e

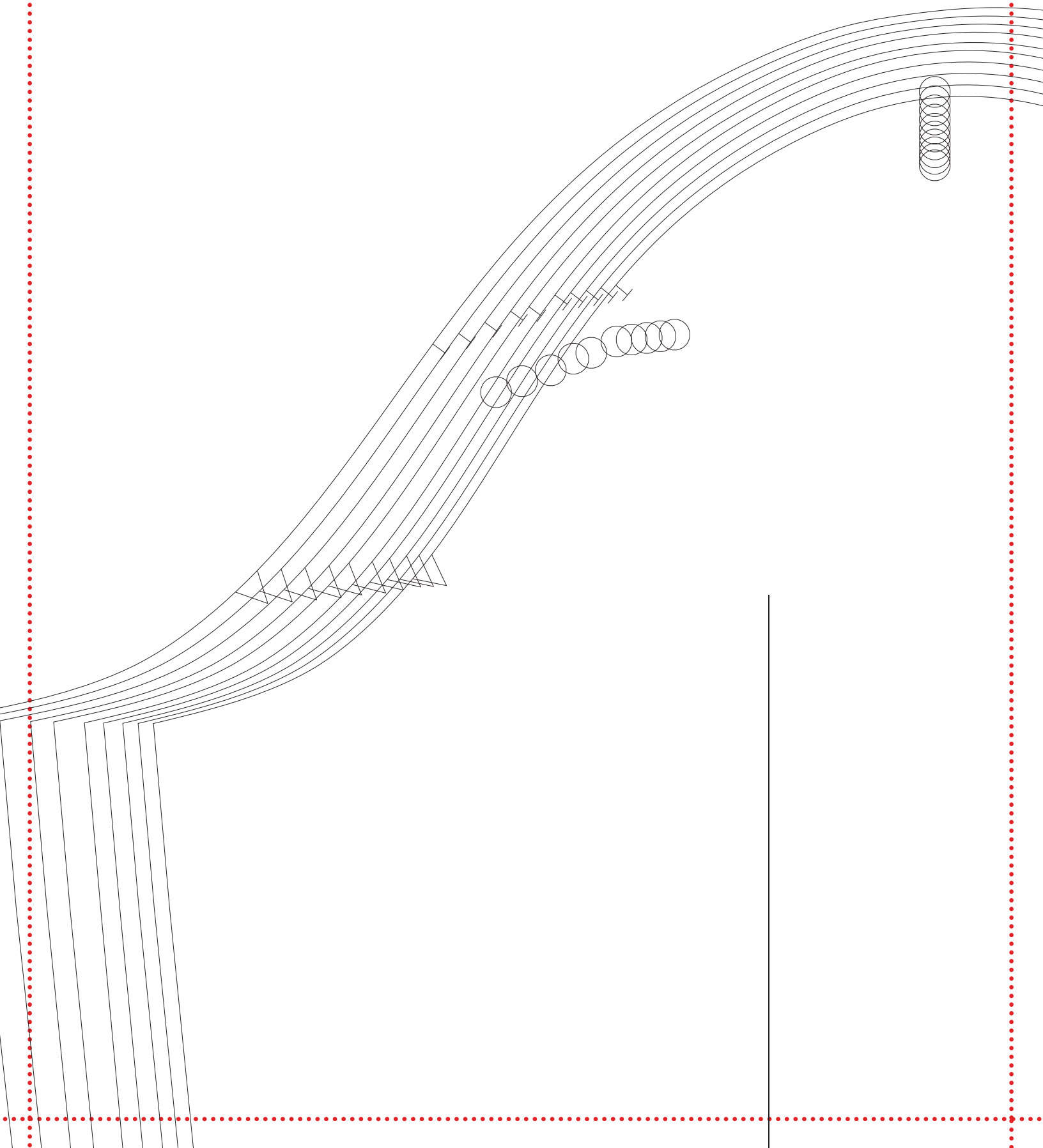

1f

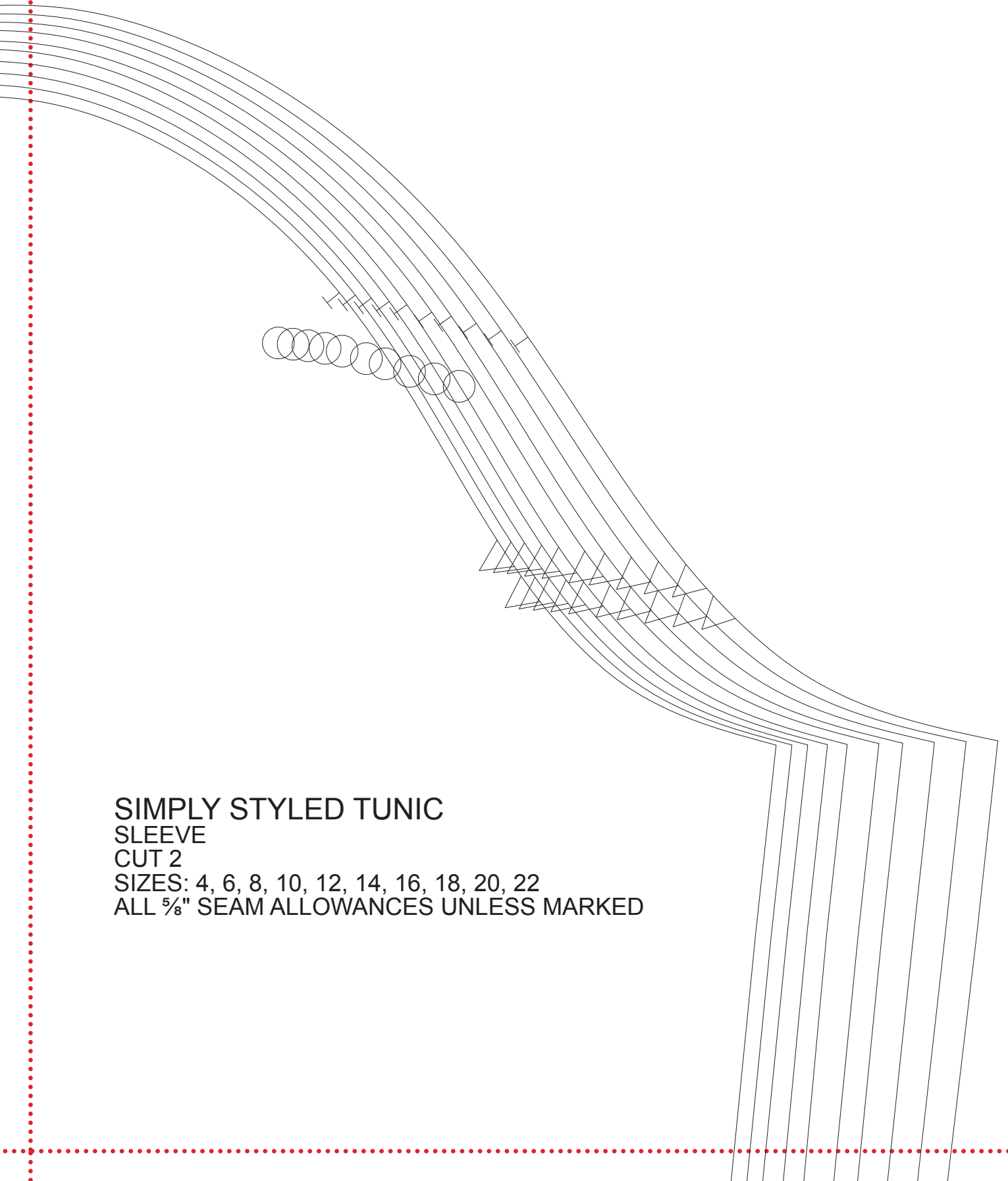

**SIMPLY STYLED TUNIC**

SLEEVE

CUT 2

SIZES: 4, 6, 8, 10, 12, 14, 16, 18, 20, 22

ALL  $\frac{5}{8}$ " SEAM ALLOWANCES UNLESS MARKED



2a

1/2" SEAM ALLOWANCE

CENTER FRONT

SIMPLY STYLED TUNIC  
FRONT  
CUT 1 ON CF FOLD  
SIZES: 4, 6, 8, 10, 12, 14, 16, 18, 20, 22  
ALL 5/8" SEAM ALLOWANCES UNLESS MARKED

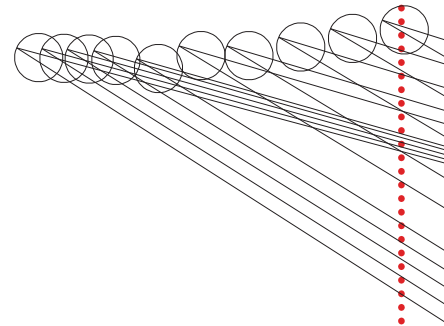

2b

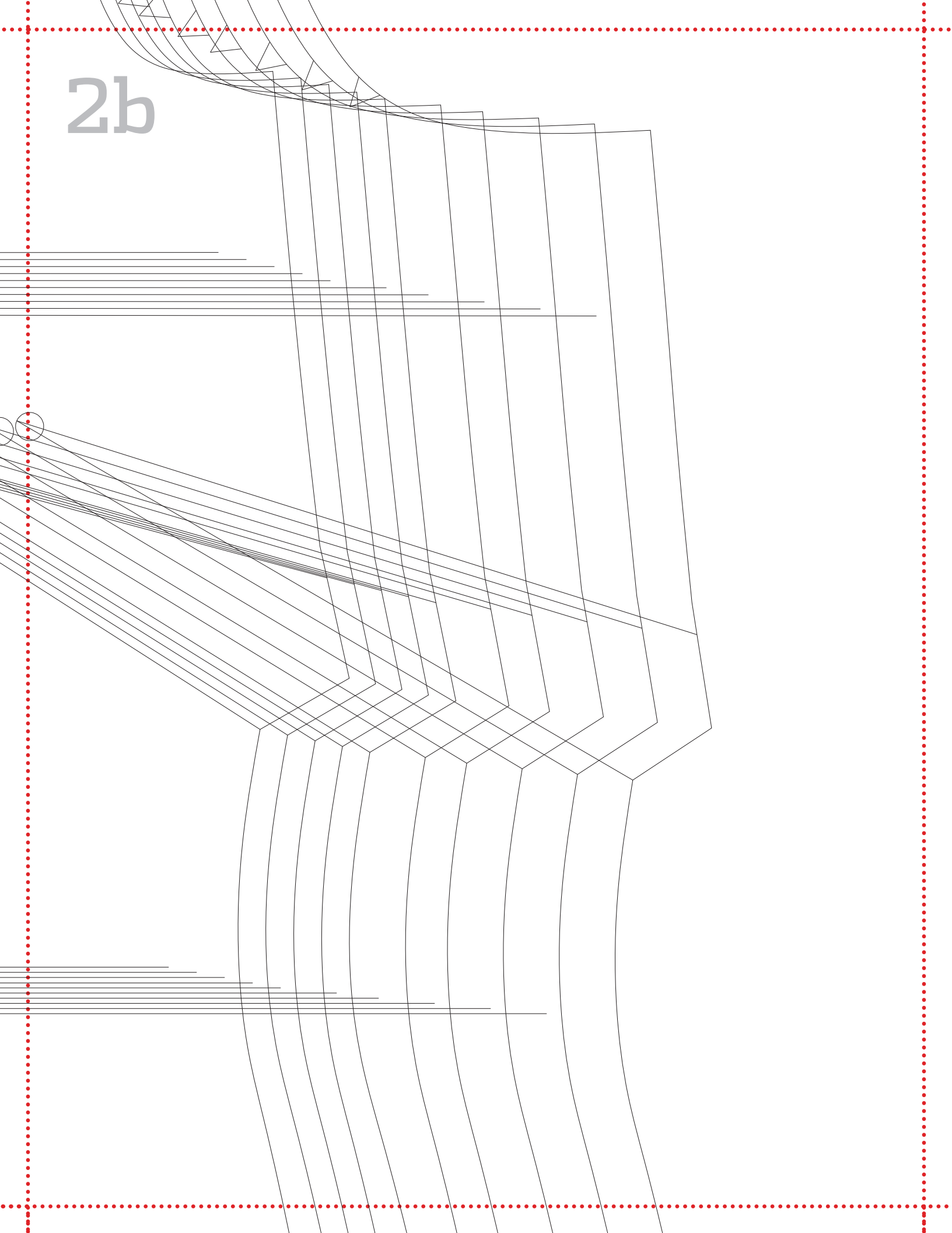

2c

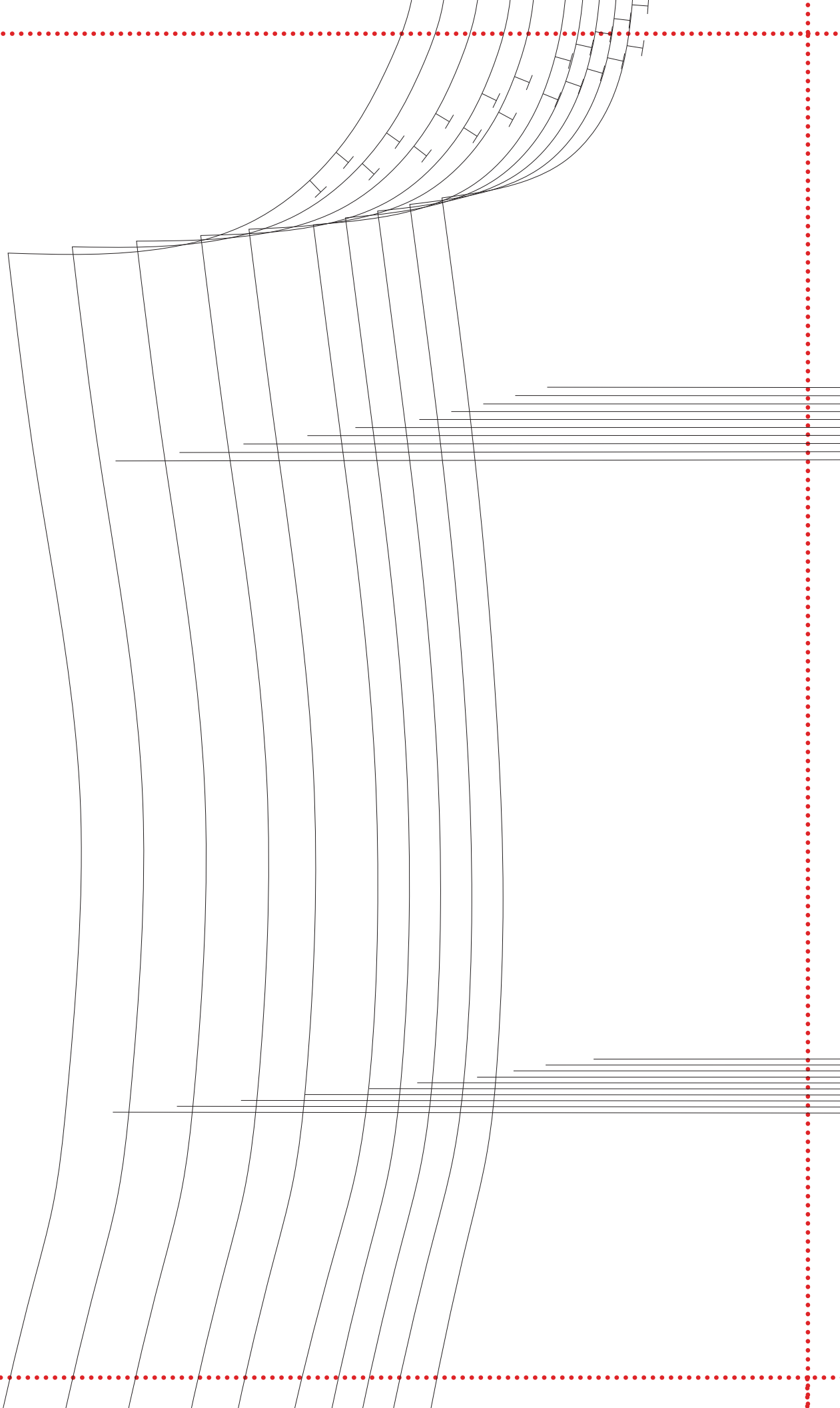

2d

SIMPLY STYLED TUNIC

BACK

CUT 1 ON CB FOLD

SIZES: 4, 6, 8, 10, 12, 14, 16, 18, 20, 22

ALL  $\frac{5}{8}$ " SEAM ALLOWANCES UNLESS MARKED

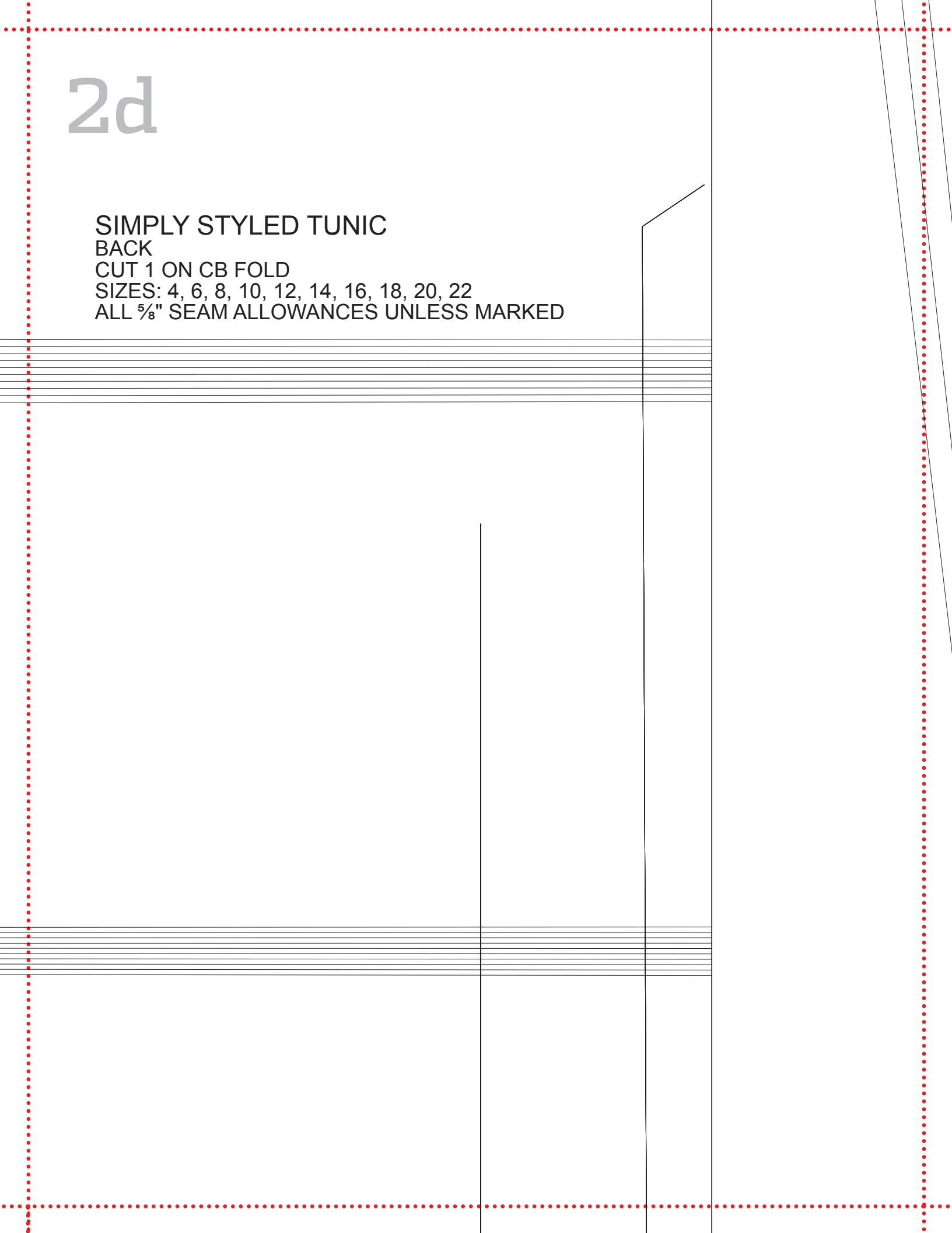
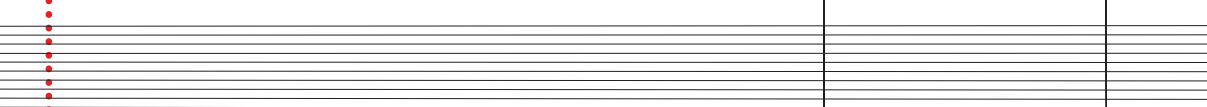

2e

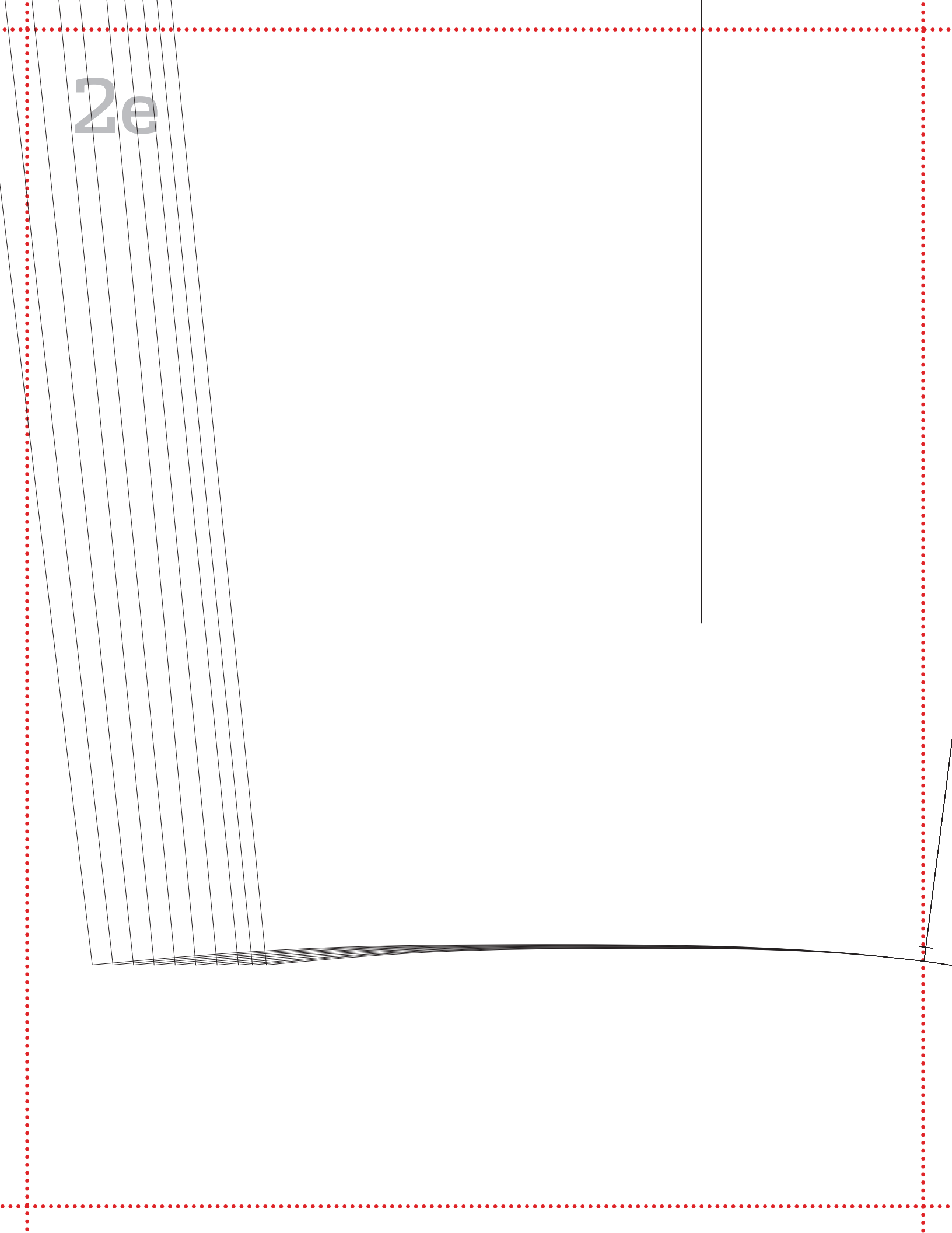

2f

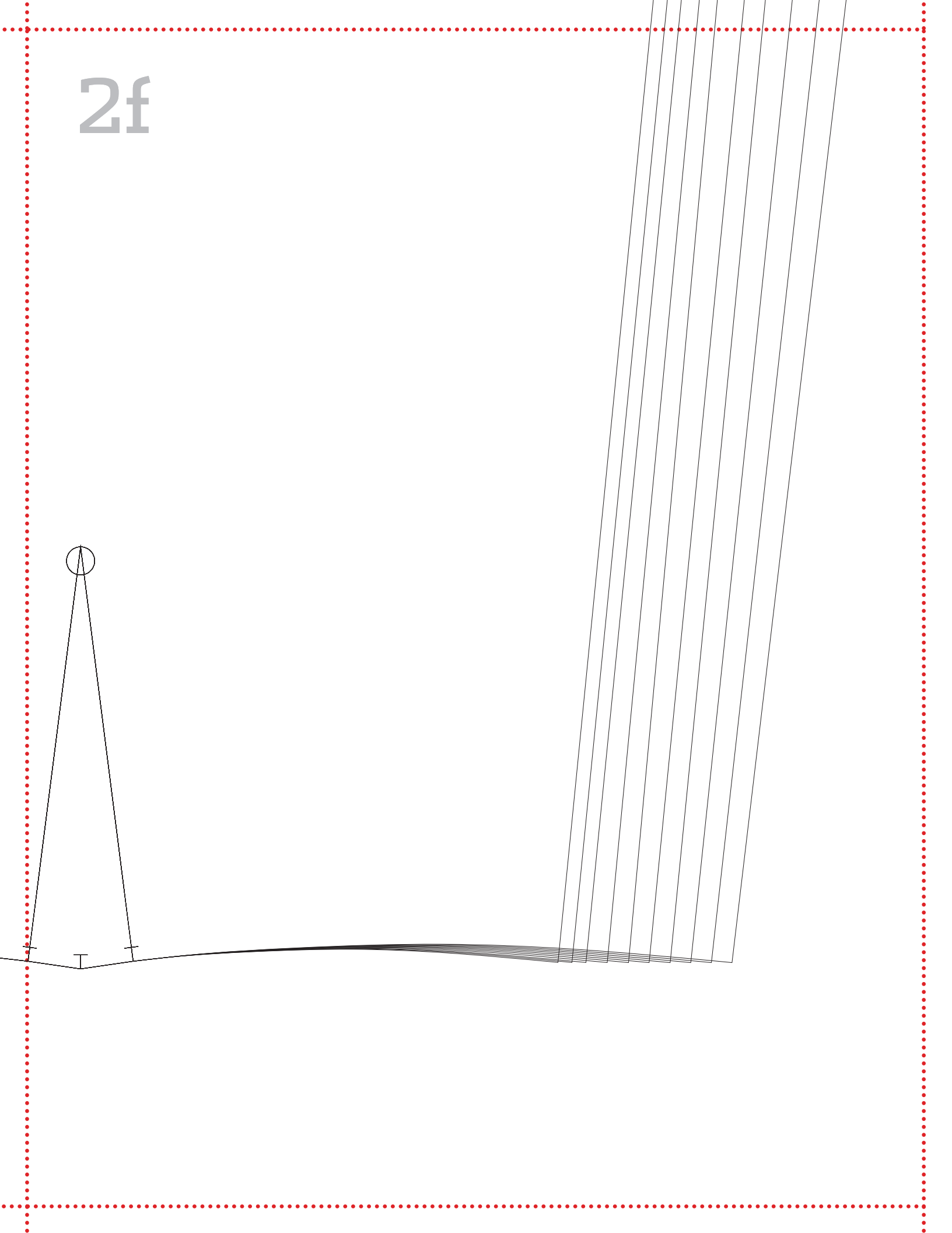

3a

NT

PLACE ON FOLD



3b

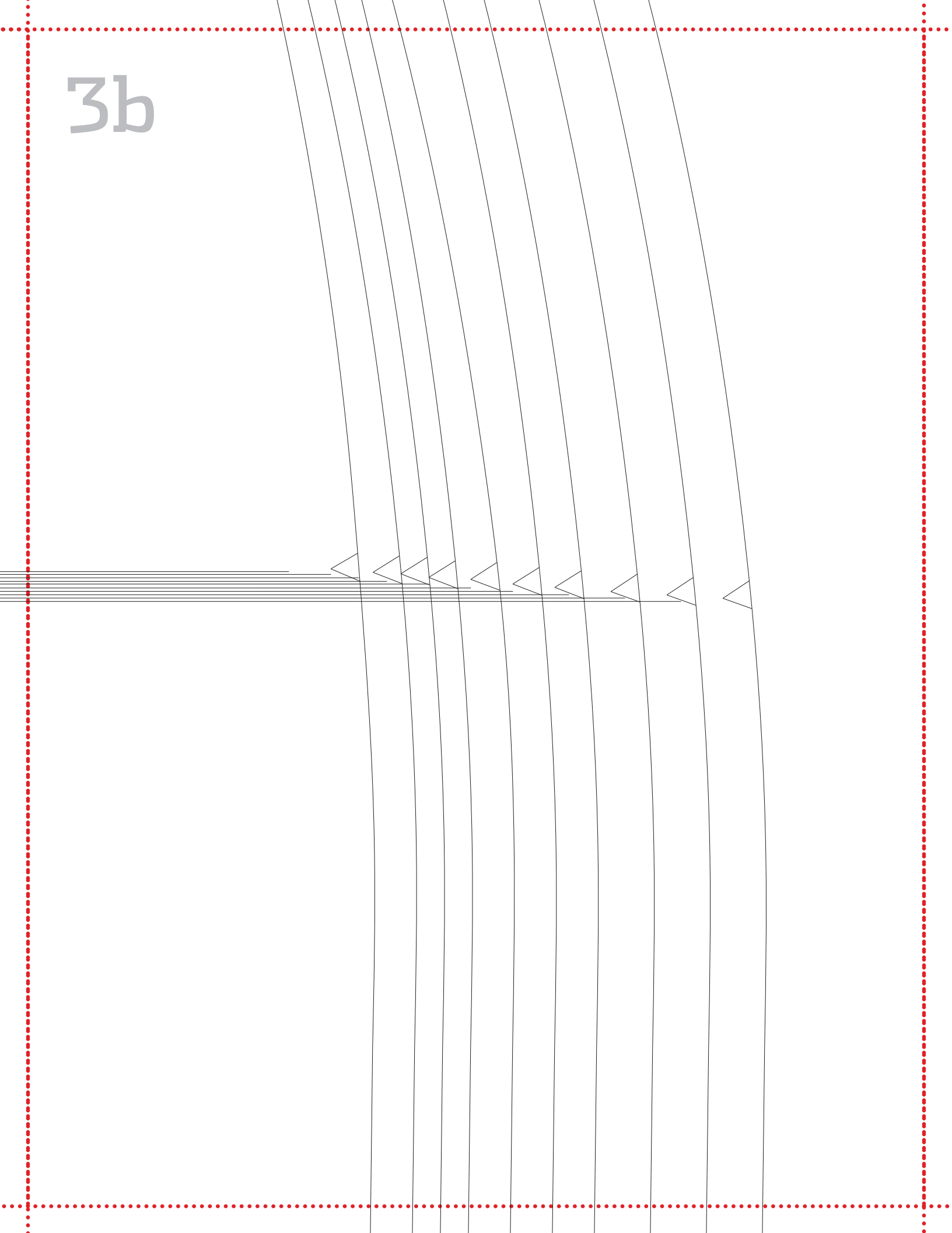



3c

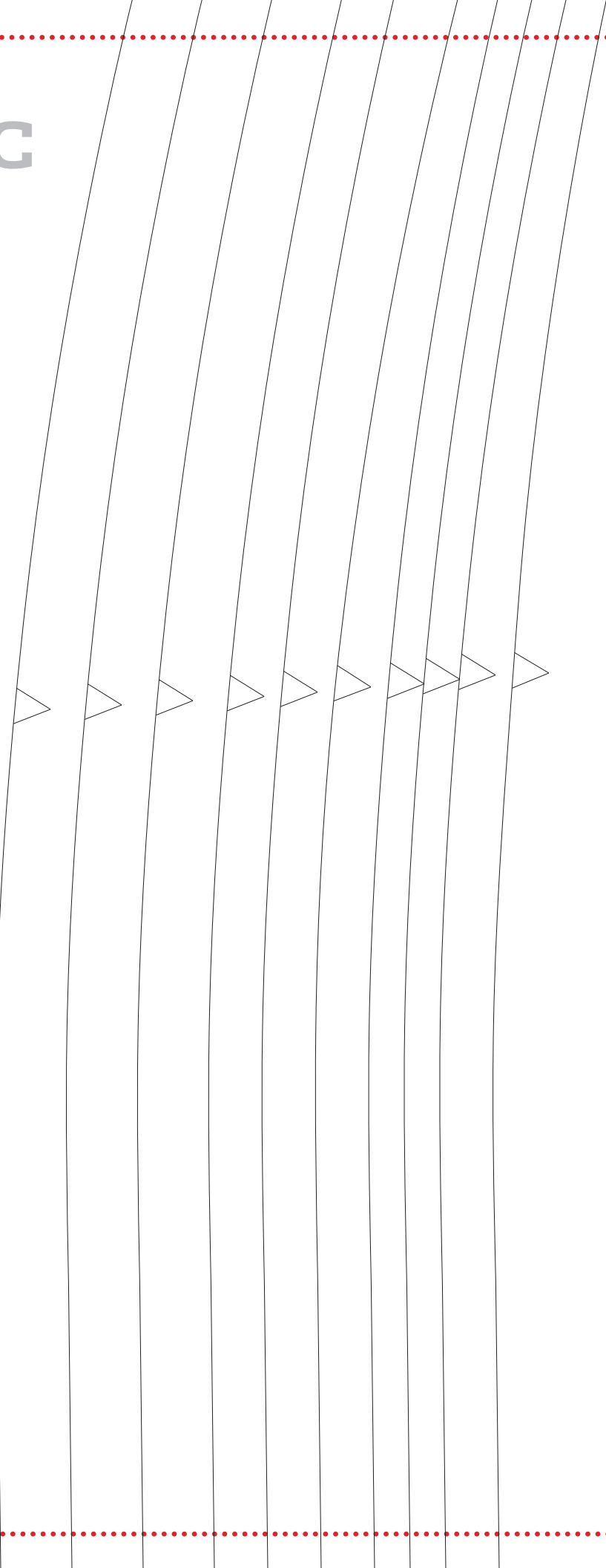

3d

PLACE ON FOLD

CENTER BACK

3e

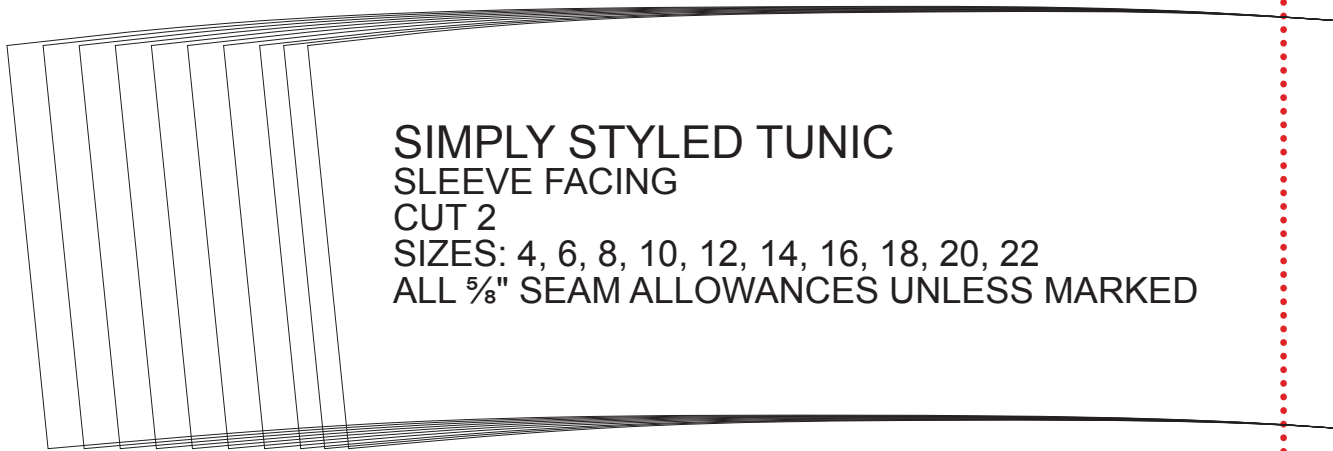

**SIMPLY STYLED TUNIC**

SLEEVE FACING

CUT 2

SIZES: 4, 6, 8, 10, 12, 14, 16, 18, 20, 22

ALL  $\frac{5}{8}$ " SEAM ALLOWANCES UNLESS MARKED

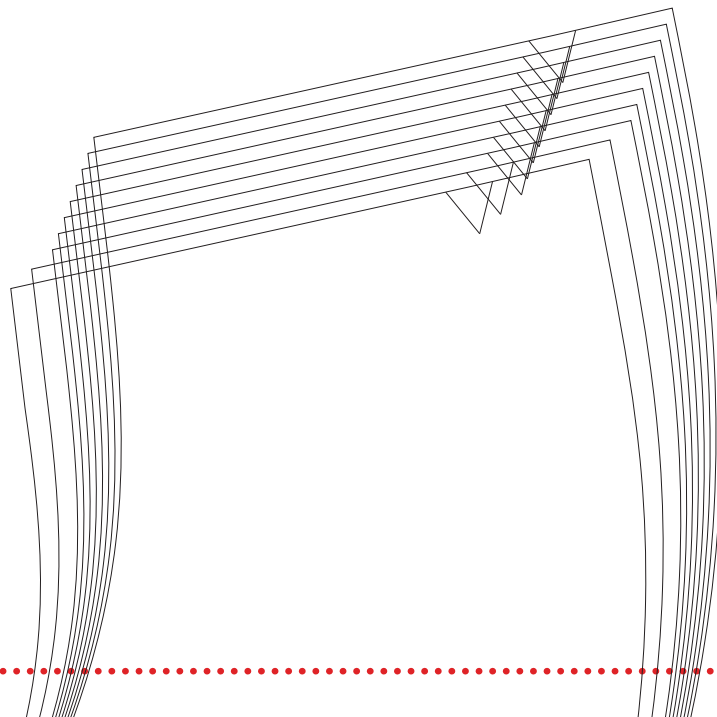

3f

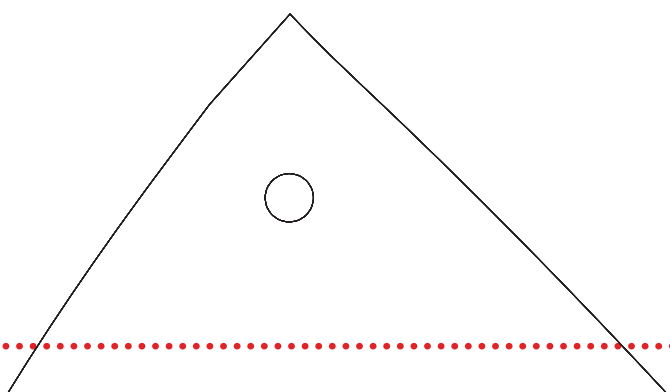
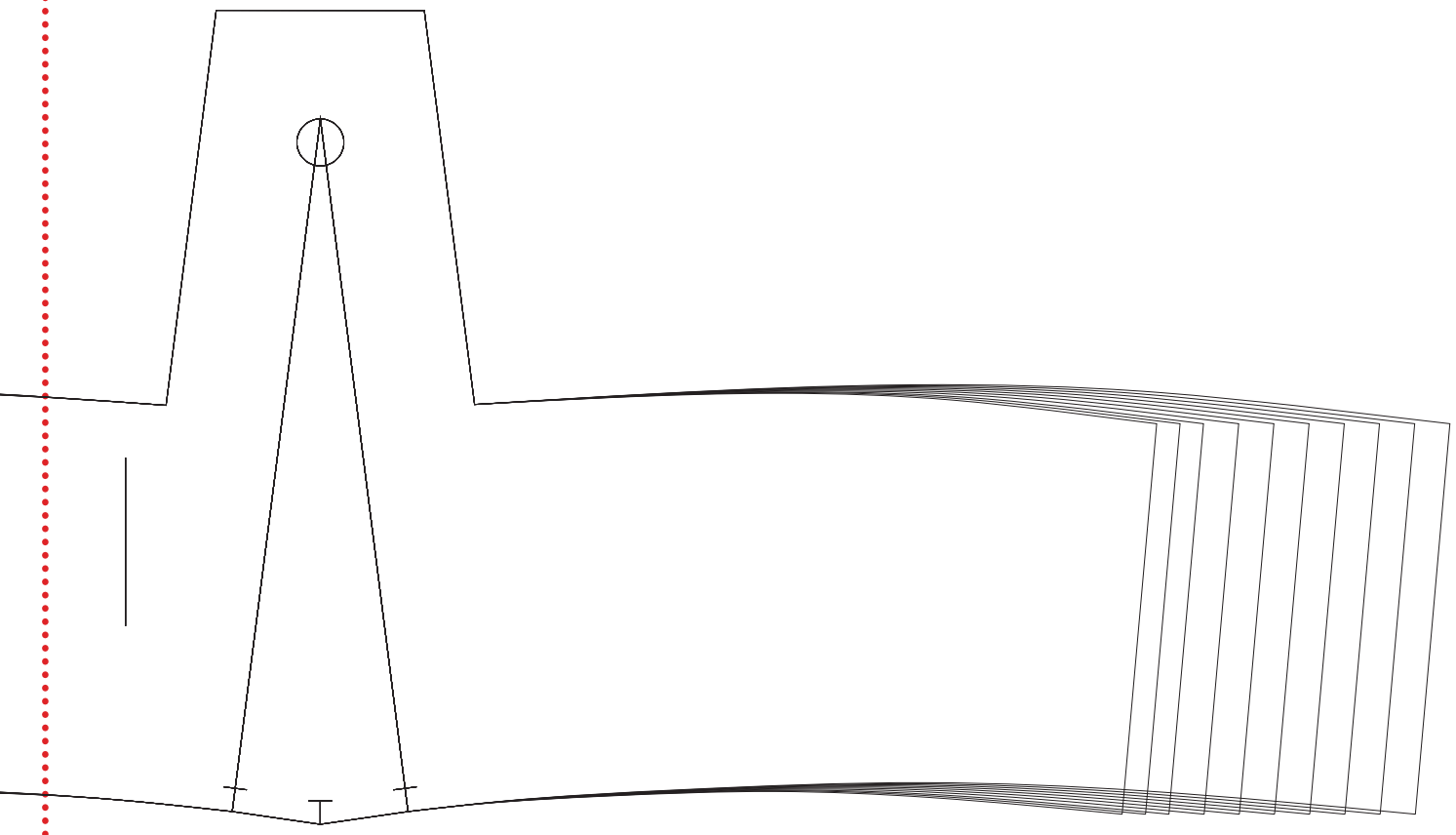

4a

The diagram consists of a large rectangular frame defined by a red dotted border. Inside this frame, there are two horizontal solid lines that divide the space into two rows. In the top-left corner, there is a small trapezoidal shape with a diagonal line extending from its top-left corner towards the center of the page. The rest of the page is blank.

4b

VENT



4c

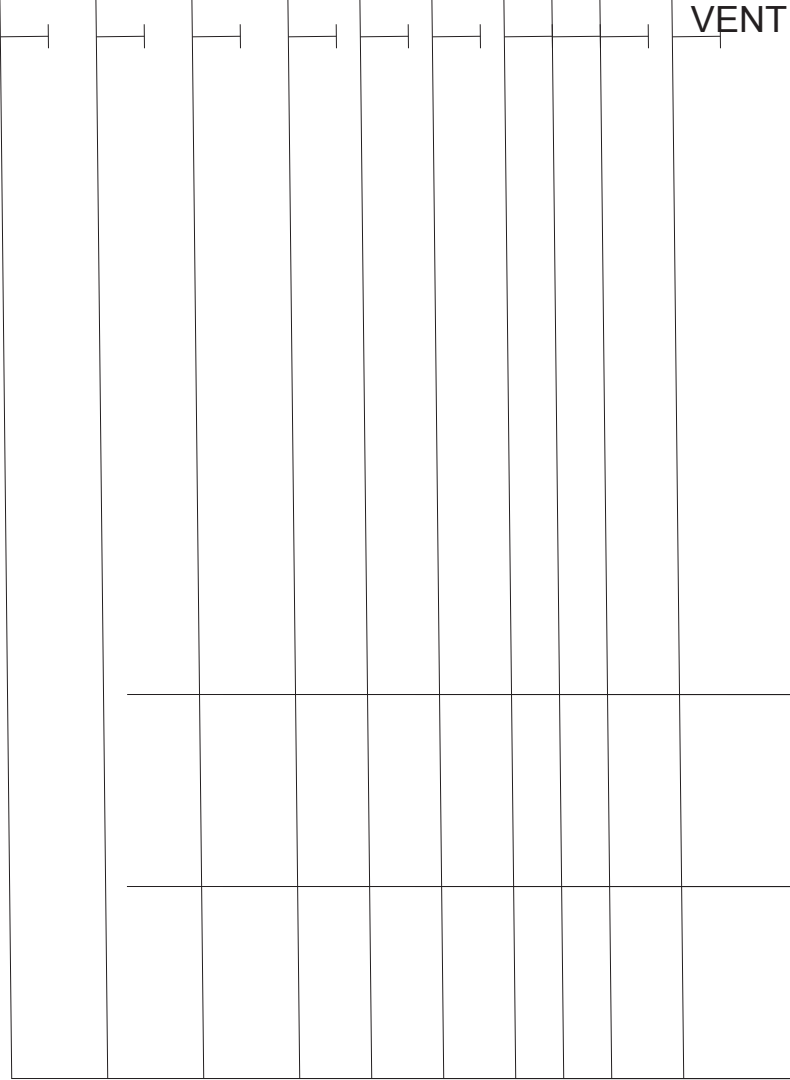

4d



4e

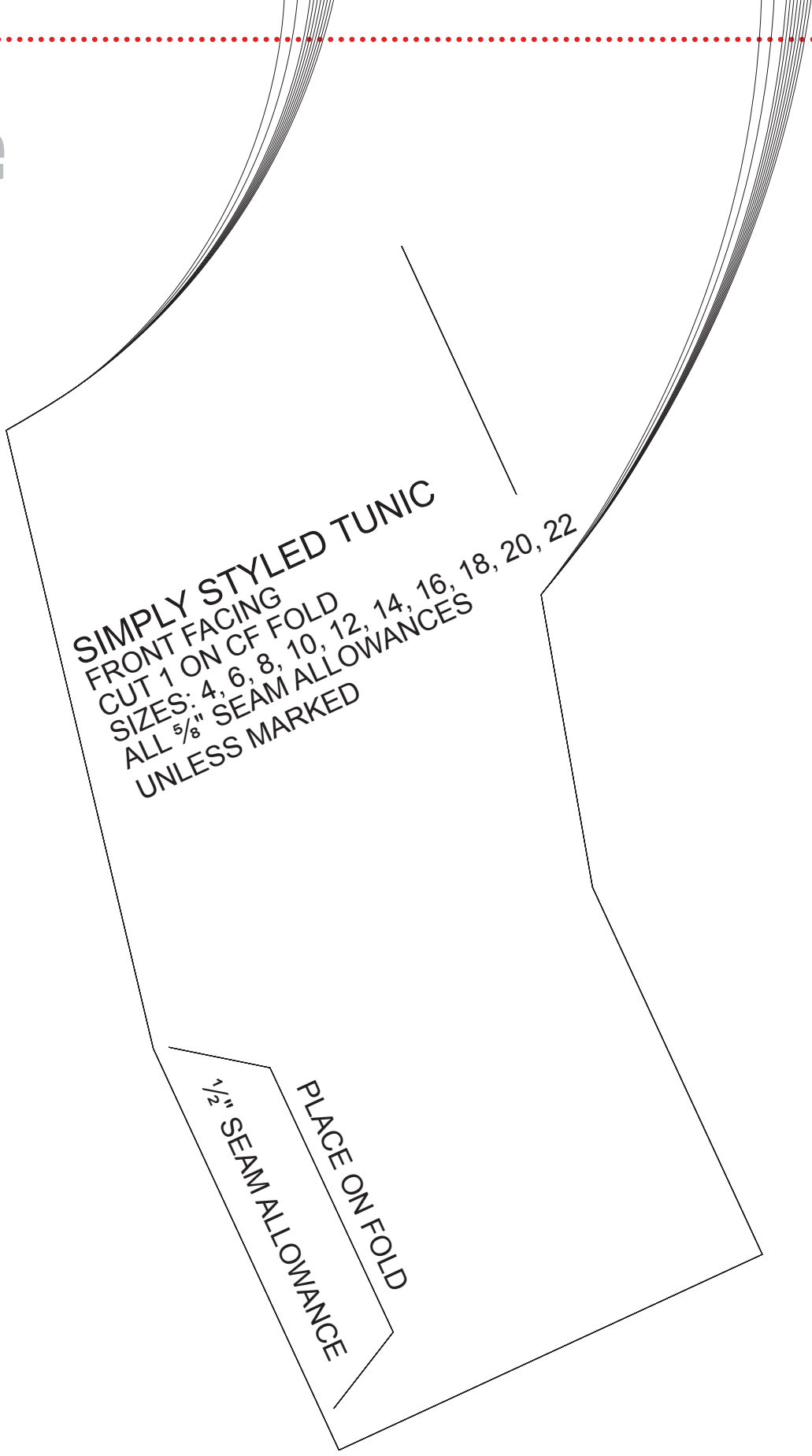

**SIMPLY STYLED TUNIC**  
FRONT FACING  
CUT 1 ON CF FOLD  
SIZES: 4, 6, 8, 10, 12, 14, 16, 18, 20, 22  
ALL  $\frac{5}{8}$ " SEAM ALLOWANCES  
UNLESS MARKED

$\frac{1}{2}$ " SEAM ALLOWANCE  
PLACE ON FOLD

4f

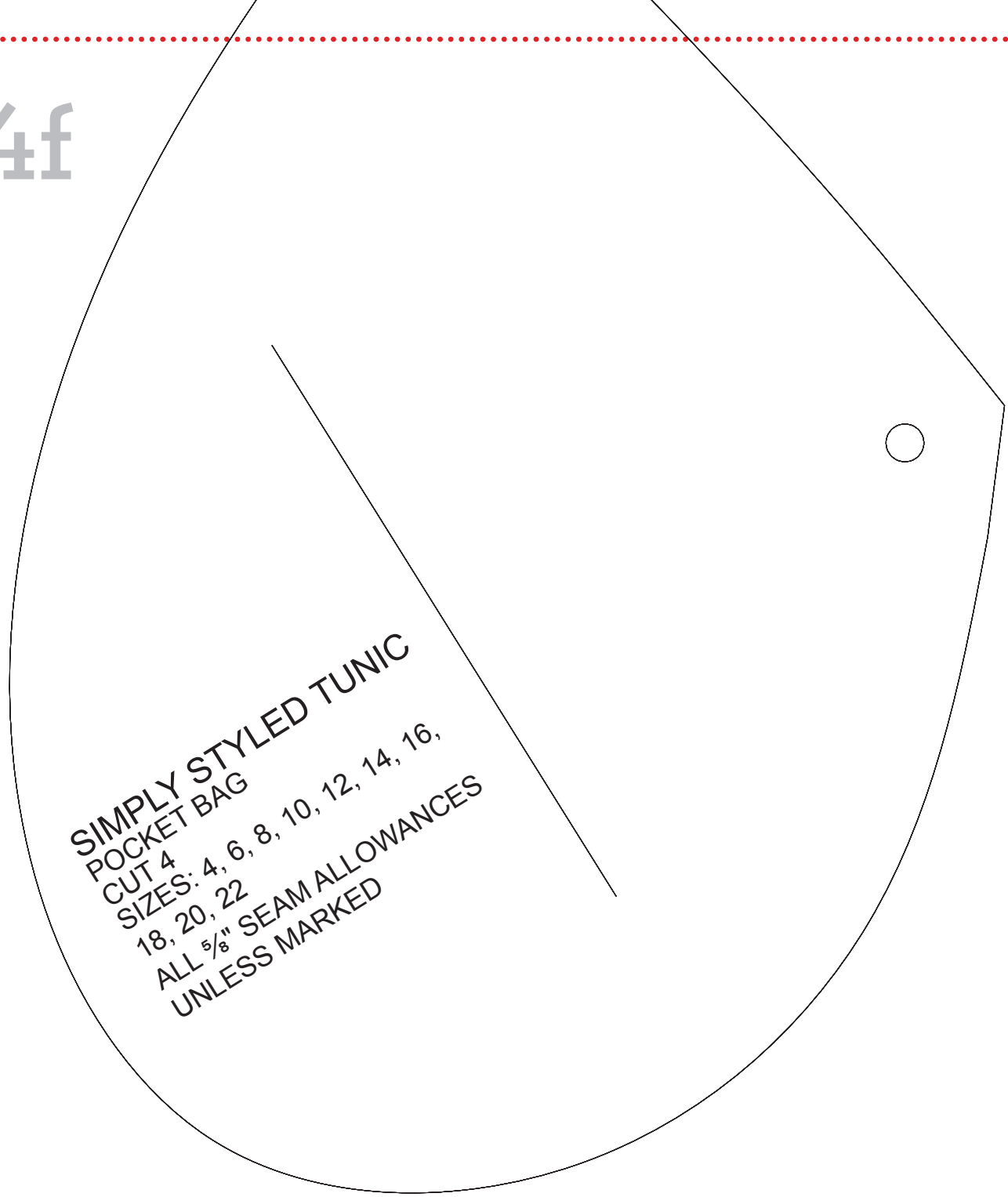

**SIMPLY STYLED TUNIC**  
**POCKET BAG**  
CUT 4  
SIZES: 4, 6, 8, 10, 12, 14, 16,  
18, 20, 22  
ALL  $\frac{5}{8}$ " SEAM ALLOWANCES  
UNLESS MARKED