

The Twirly Dress Size Chart

Size	12M	18M	2T	3T	4T	5T	6T
Chest/waist in/cm	18/45.7	19/48.3	20/50.8	21/53.3	22/55.9	23/58.4	24/61

full photo tutorial for putting this all together: <http://nap-timecreations.com/2016/11/the-twirly-dress-free-pdf-pattern.html>



The Twirly Dress for Girls
from *Nap-Time Creations*
size 12m-6T
Hood - cut 2 in mirror
3/8 {1cm} seam allowance included

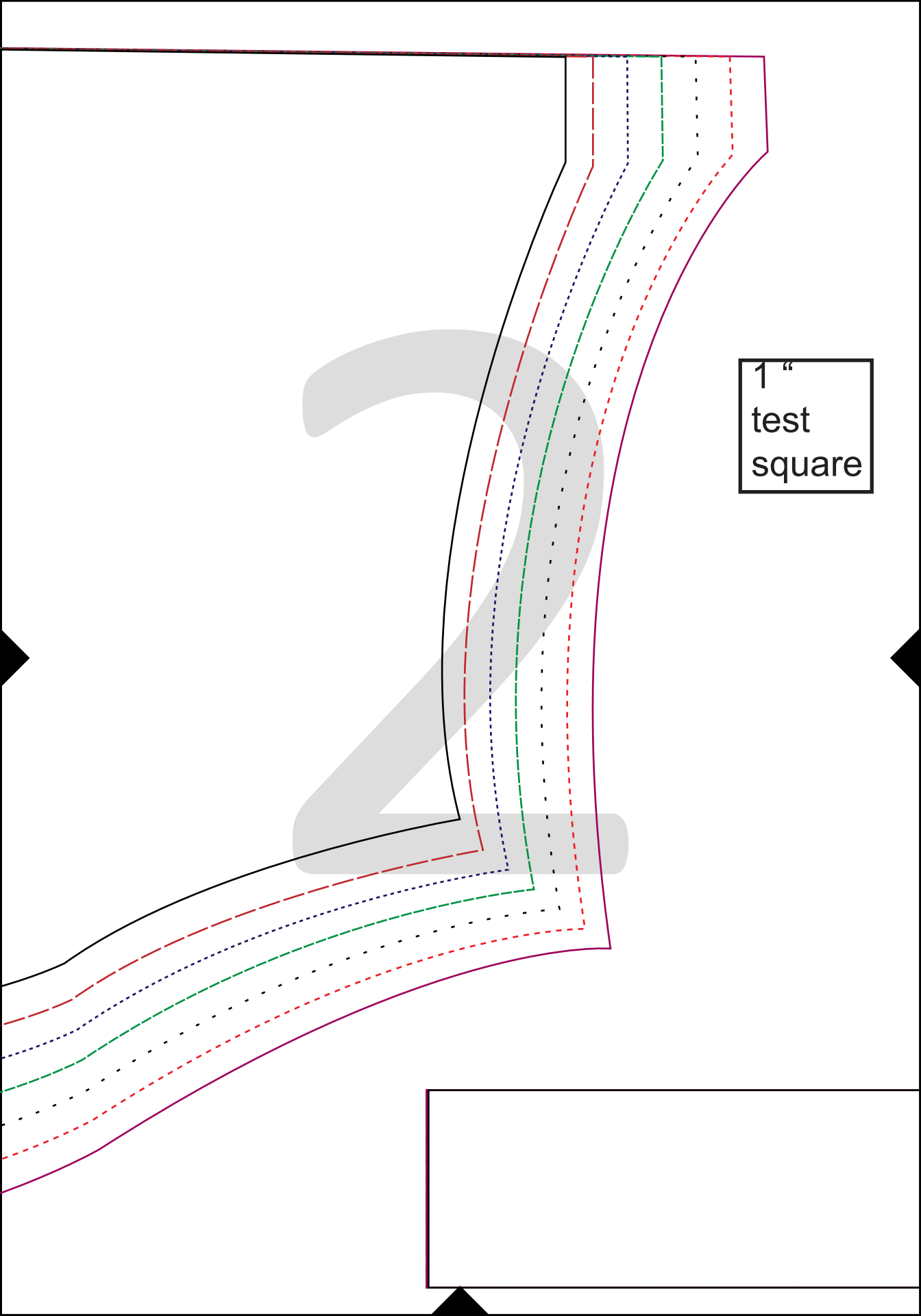

1"
test
square



Key:

12M —————

18M - - - - -

2T ······

3T - - - - -

4T ······

5T - - - - -

6T —————

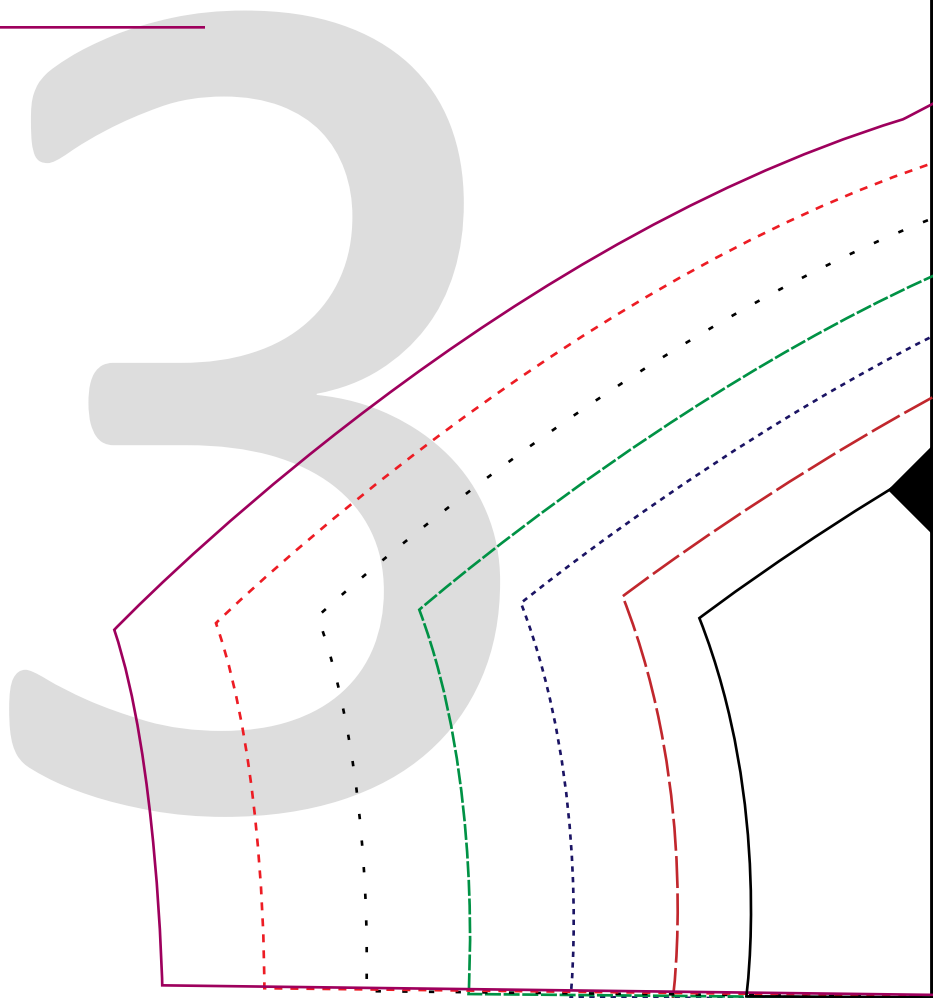

The Twirly Dress for Girls
from Nap-Time Creations
size 12m-6T

Neck Binding - cut 1
3/8 {1cm} seam allowance included

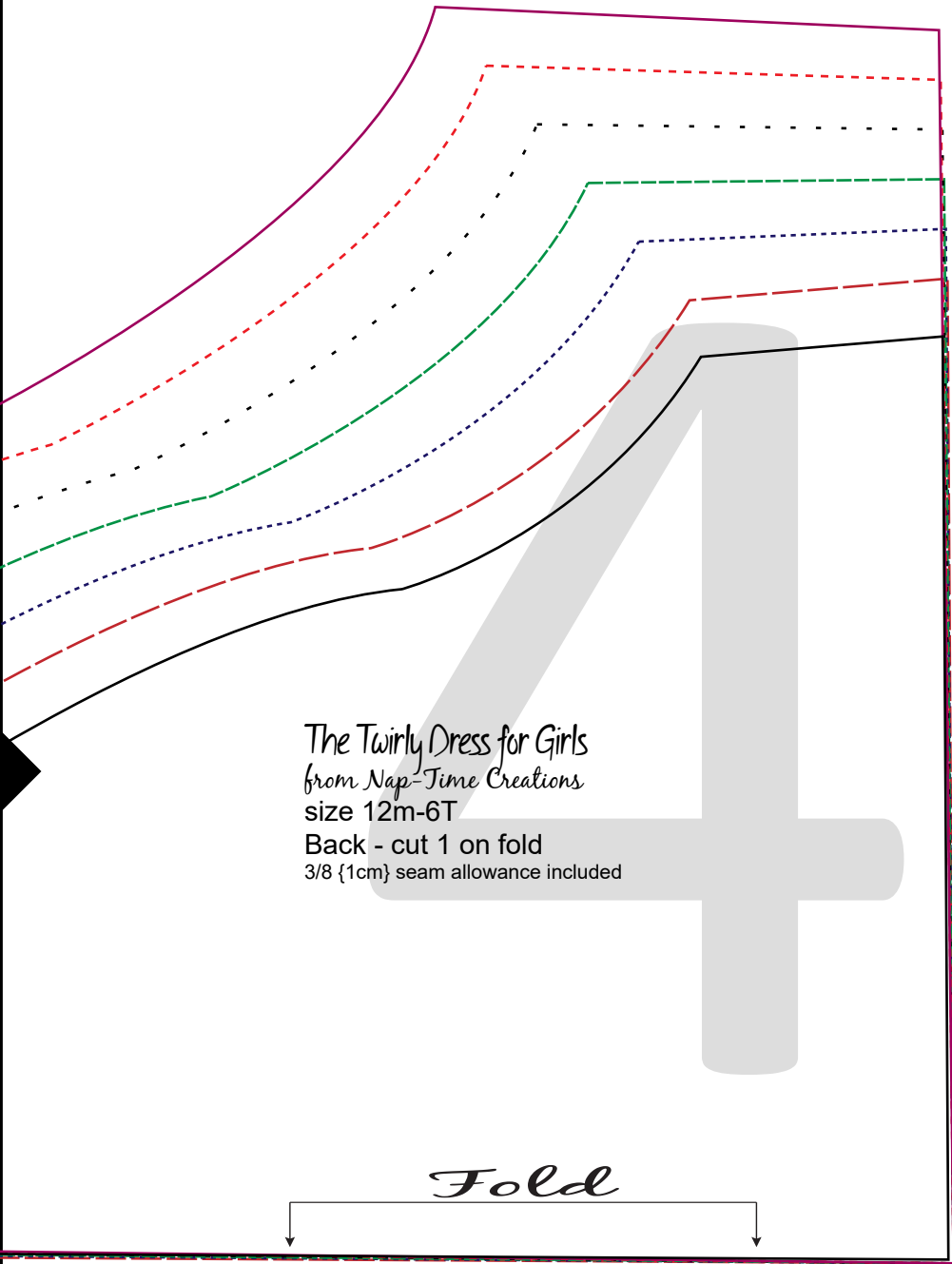

The Twirly Dress for Girls
from Nap-Time Creations
size 12m-6T
Back - cut 1 on fold
3/8 {1cm} seam allowance included

Fold

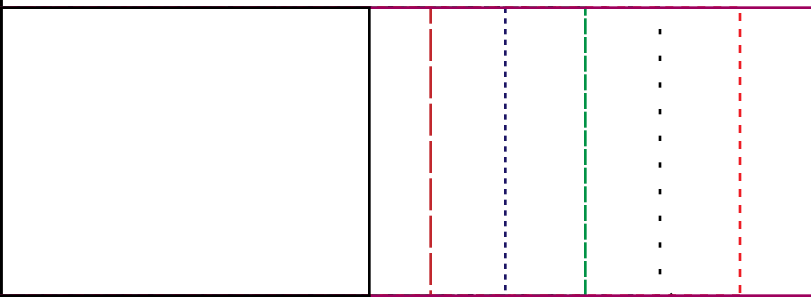

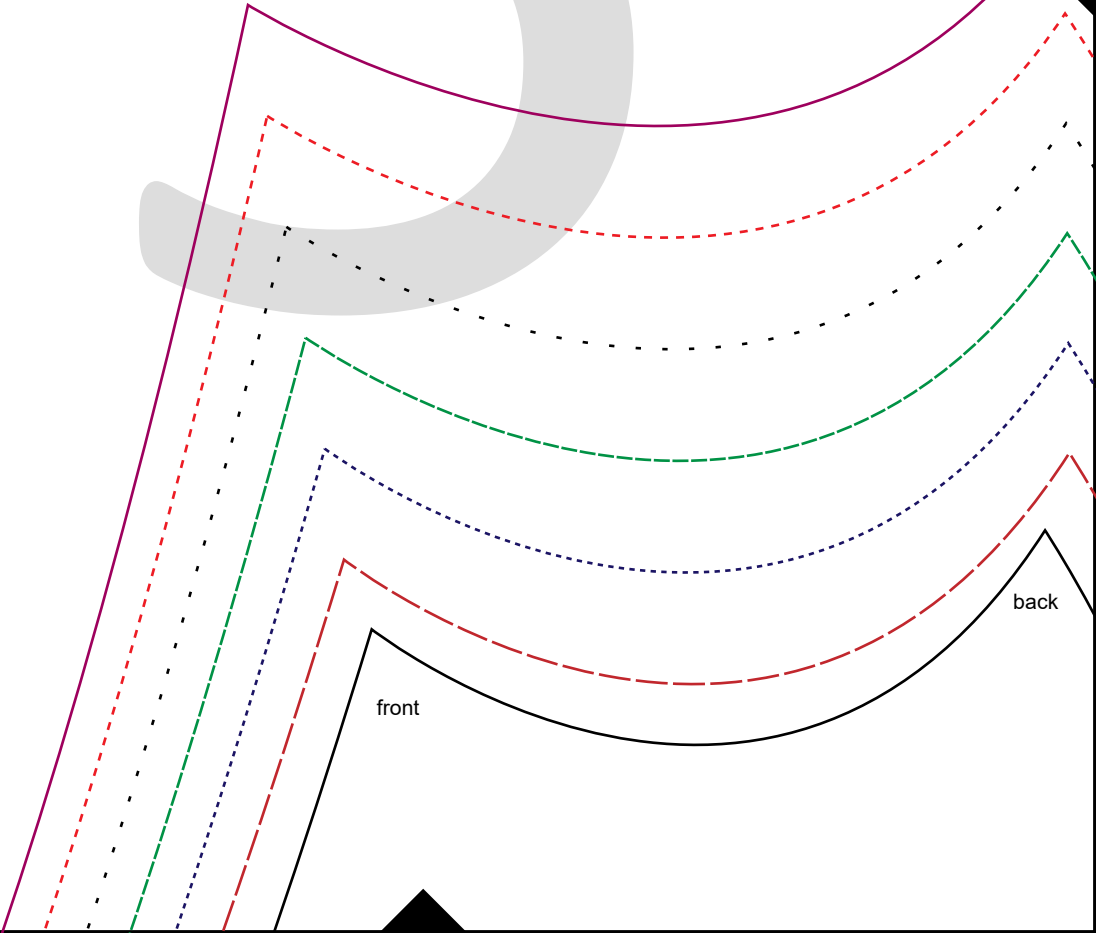
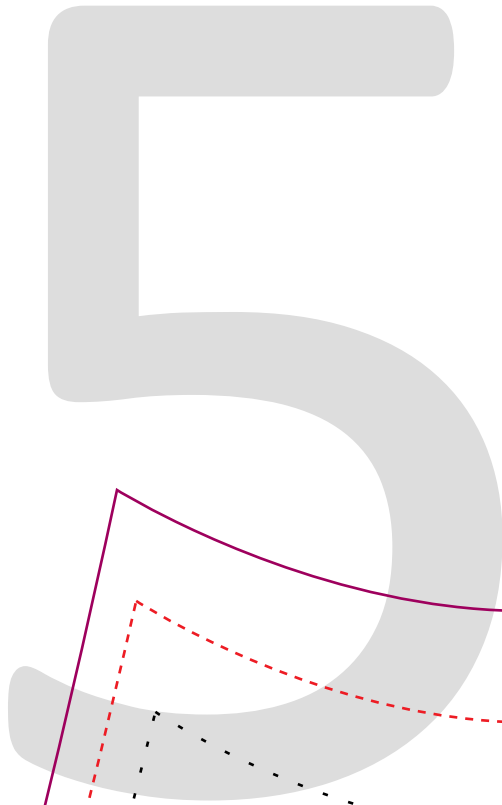

front

back

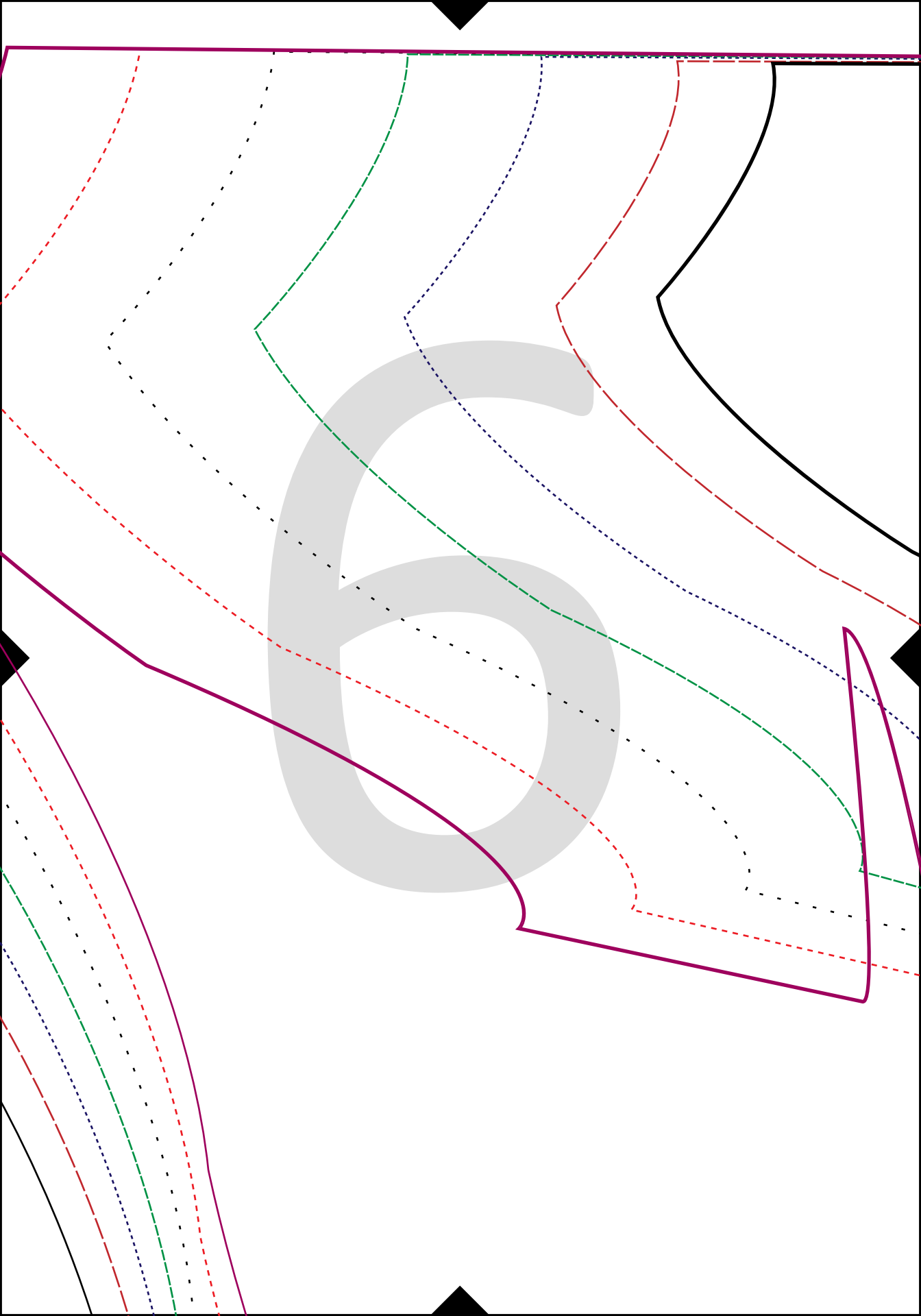

The Twirly Dress for Girls
from Nap-Time Creations
size 12m-6T

Dress Front - cut 1 on fold
3/8 {1cm} seam allowance included

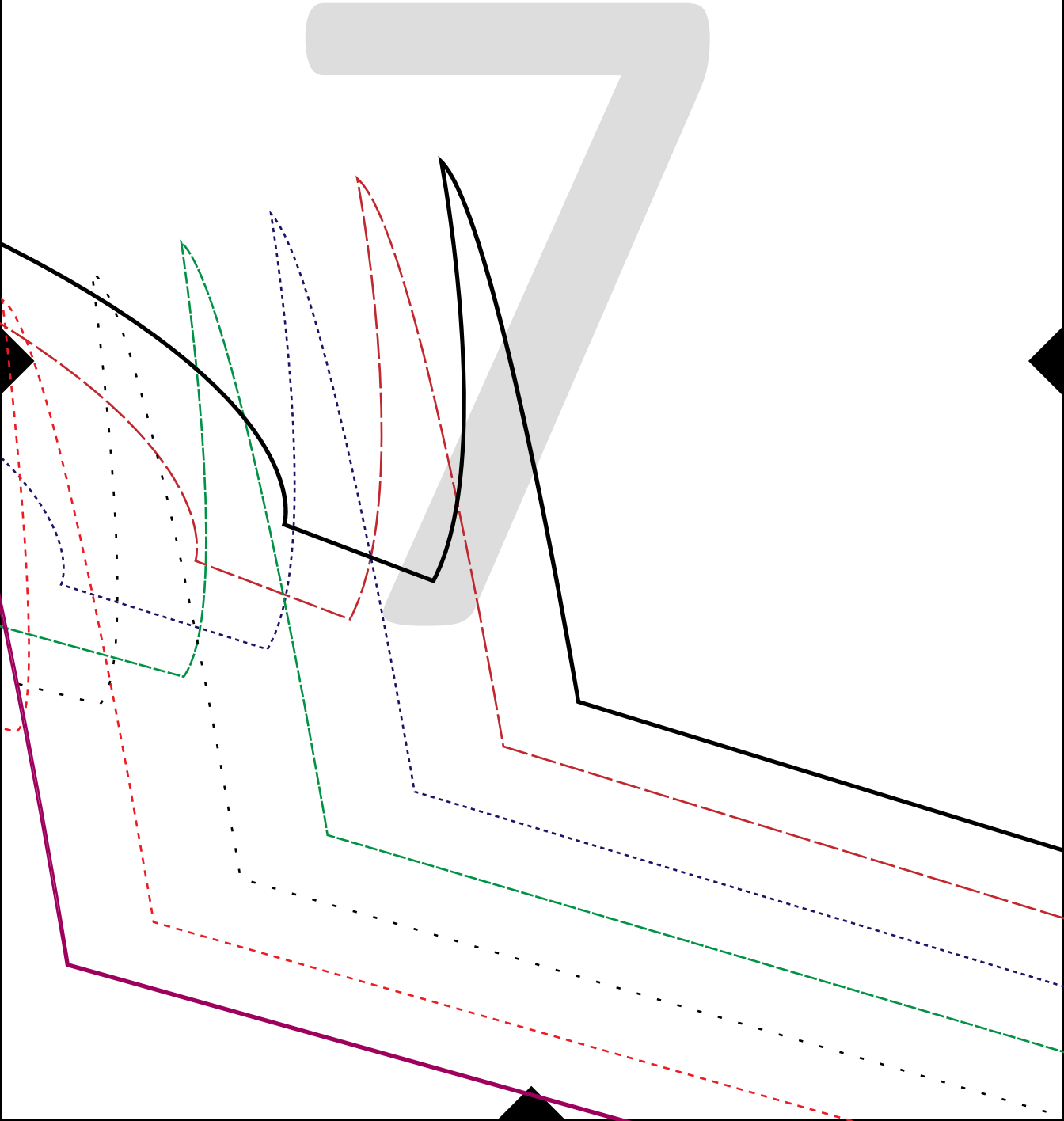

Fold

8

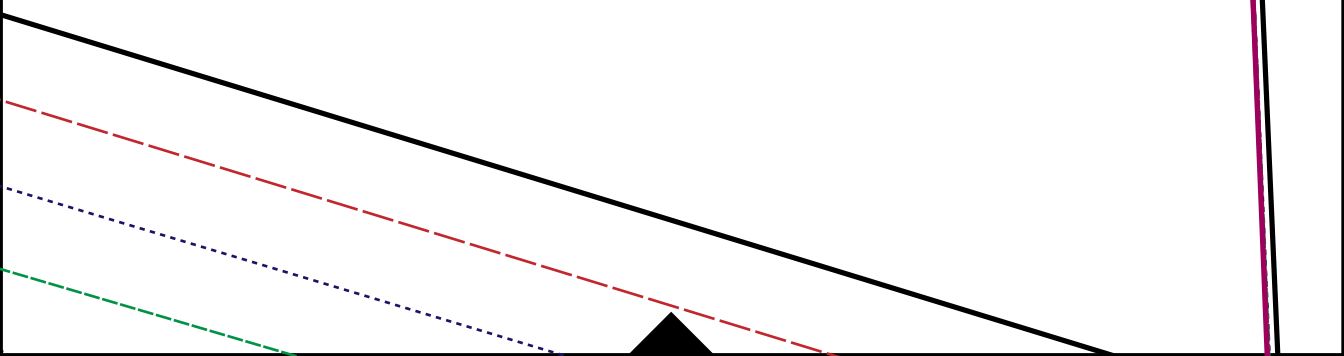



The Twirly Dress for Girls
from Nap-Time Creations
size 12m-6T

Sleeve - cut 2 in mirror
3/8 {1cm} seam allowance included

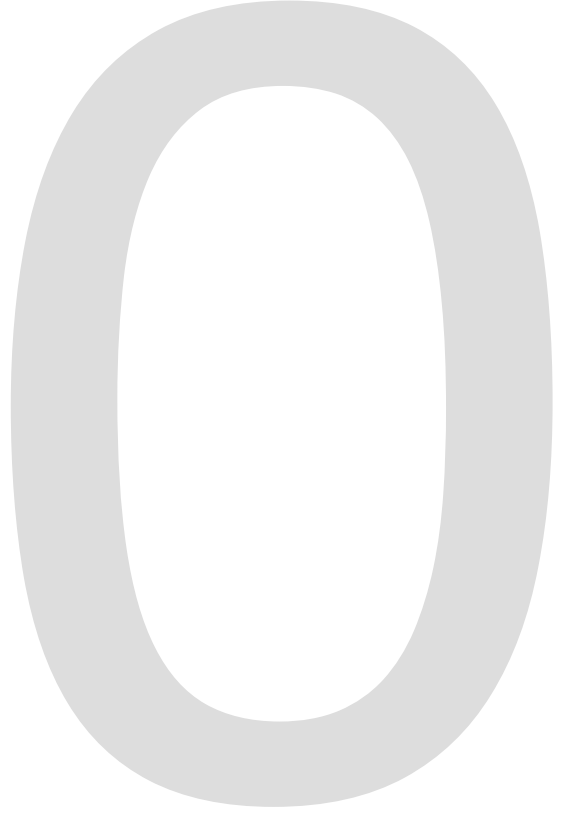
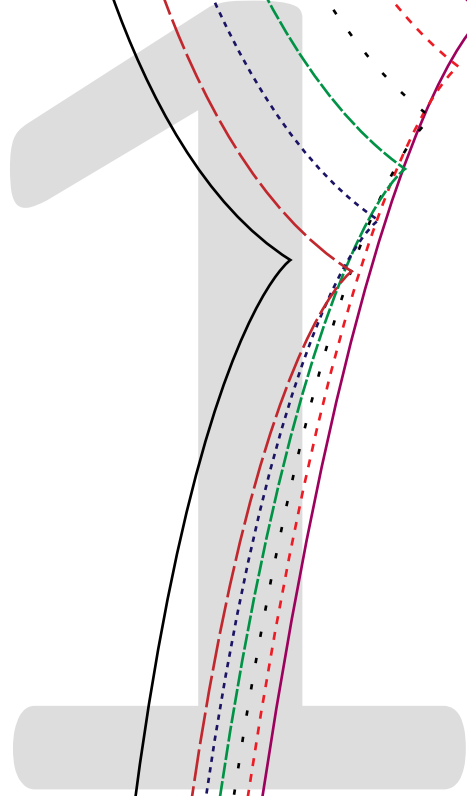



The Twirly Dress for Girls
from Nap-Time Creations

size 12m-6T

Skirt Back - cut 1

3/8 {1cm} seam allowance included

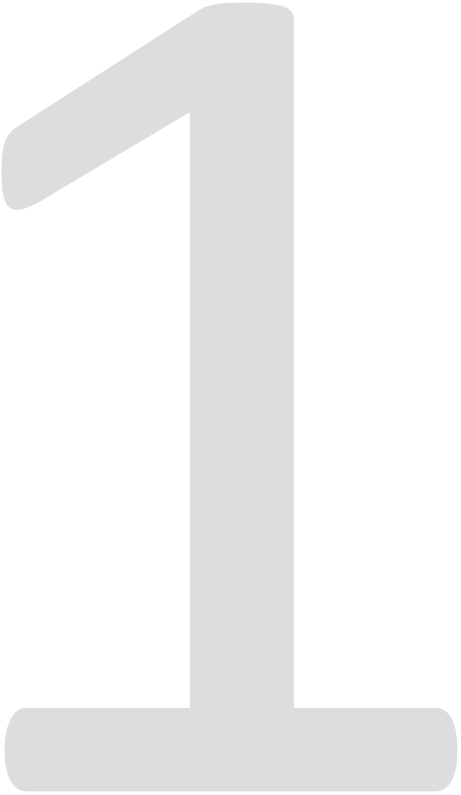

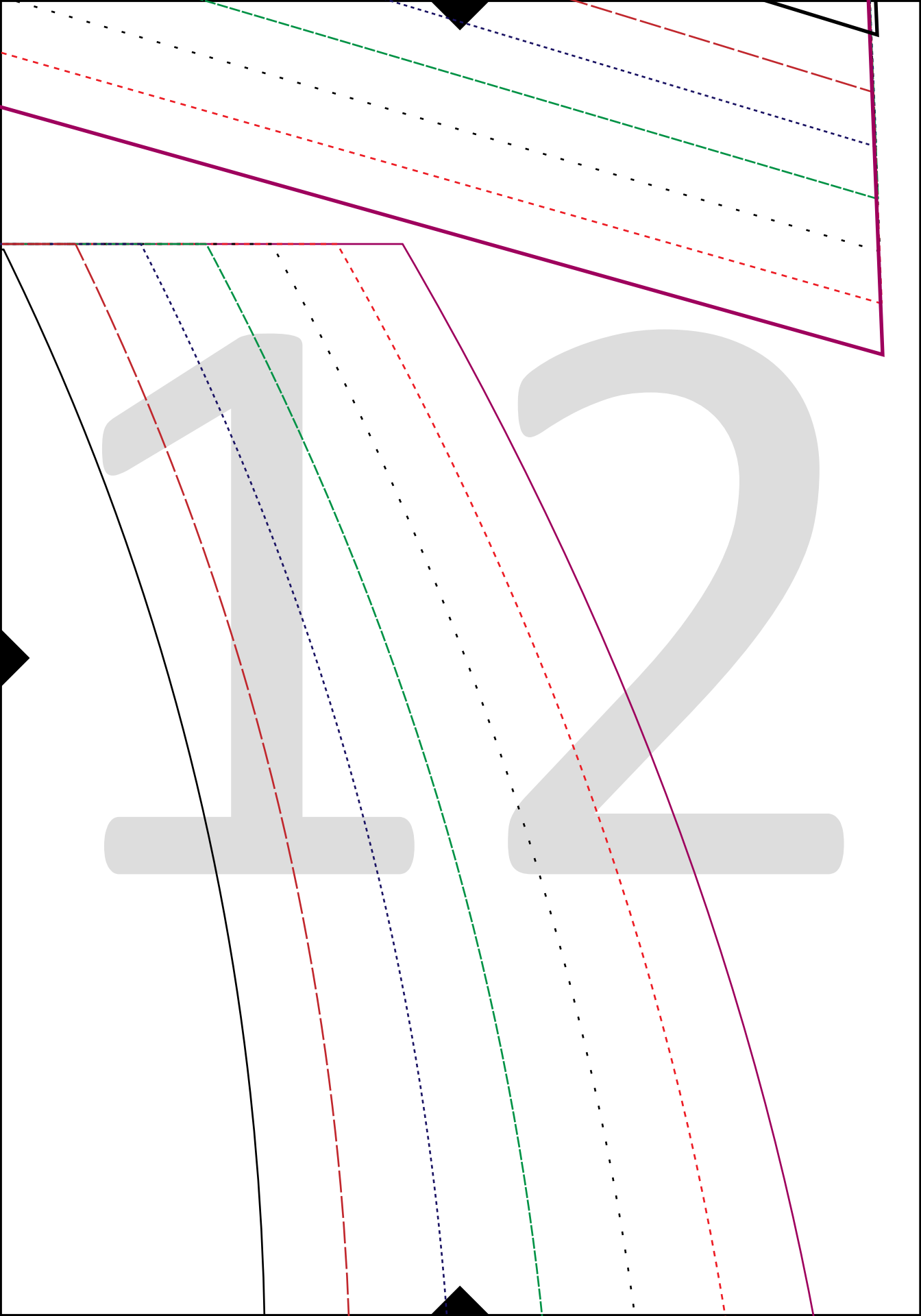

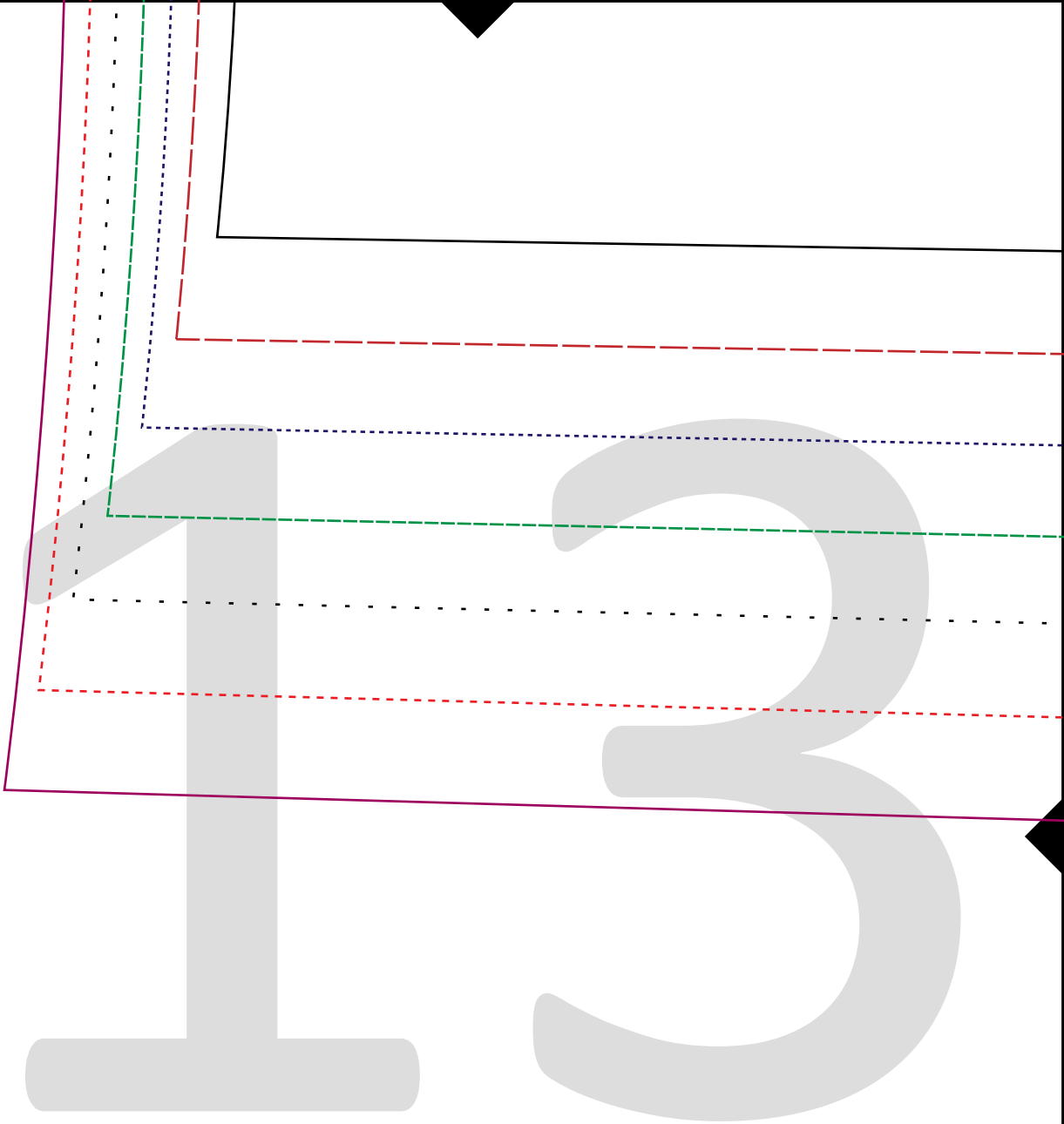

1

4

15

1

6

1

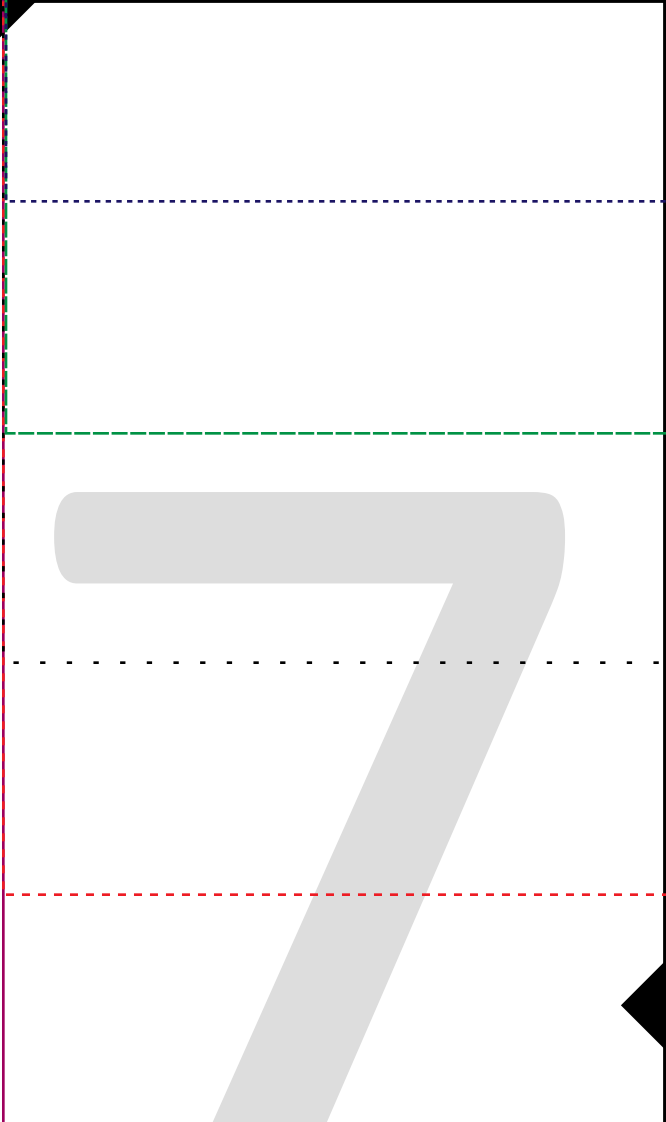

A handwriting practice box for the number 7. The box is defined by a solid purple border. Inside, there are four horizontal dashed lines: a blue line at the top, a green line below it, a black line below that, and a red line at the bottom. A large, light gray number 7 is positioned within the box, spanning from the blue line to the red line. The number 7 consists of a horizontal top bar and a diagonal stem that descends from the right side of the bar to the red line.

1

8

1

9

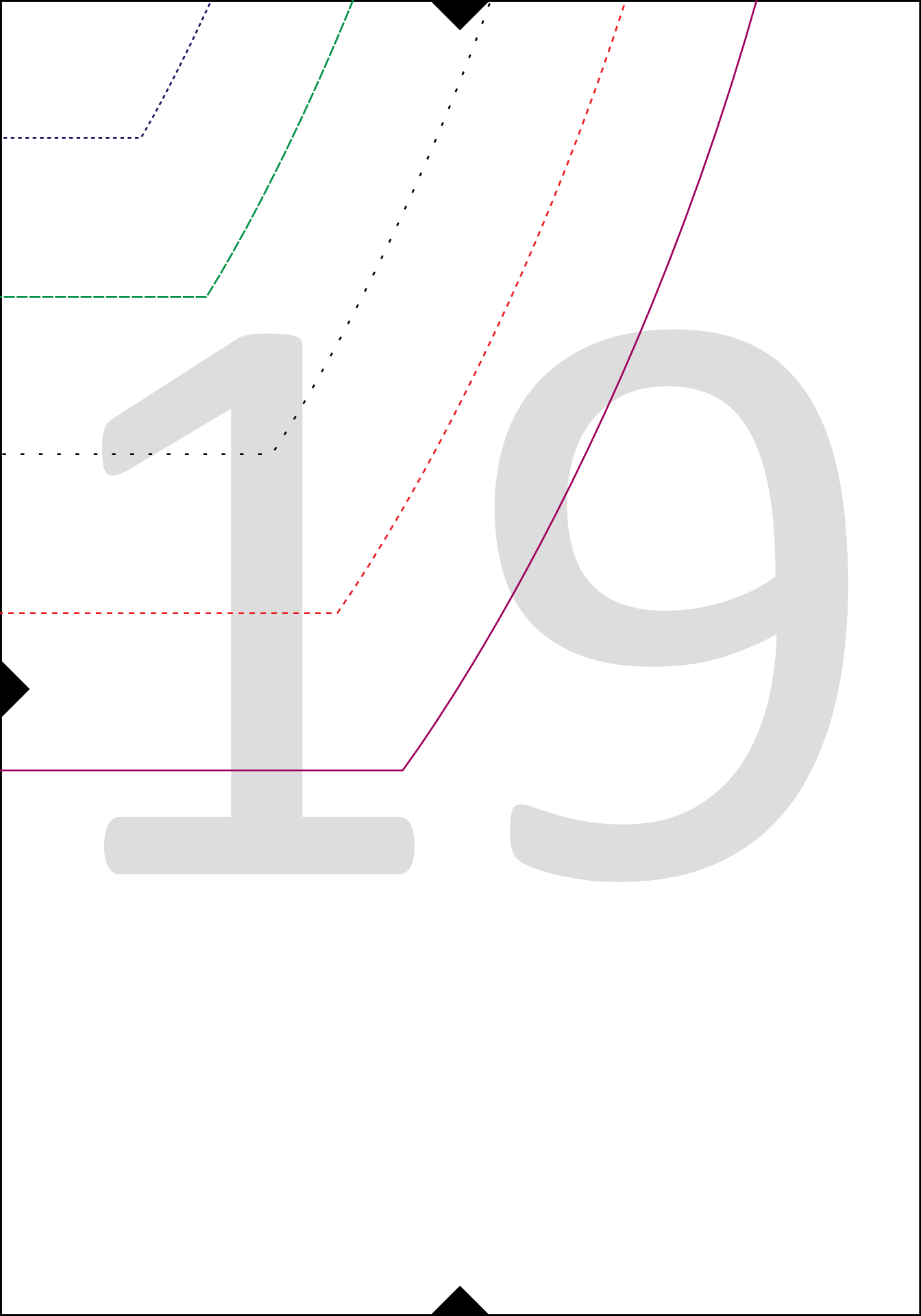

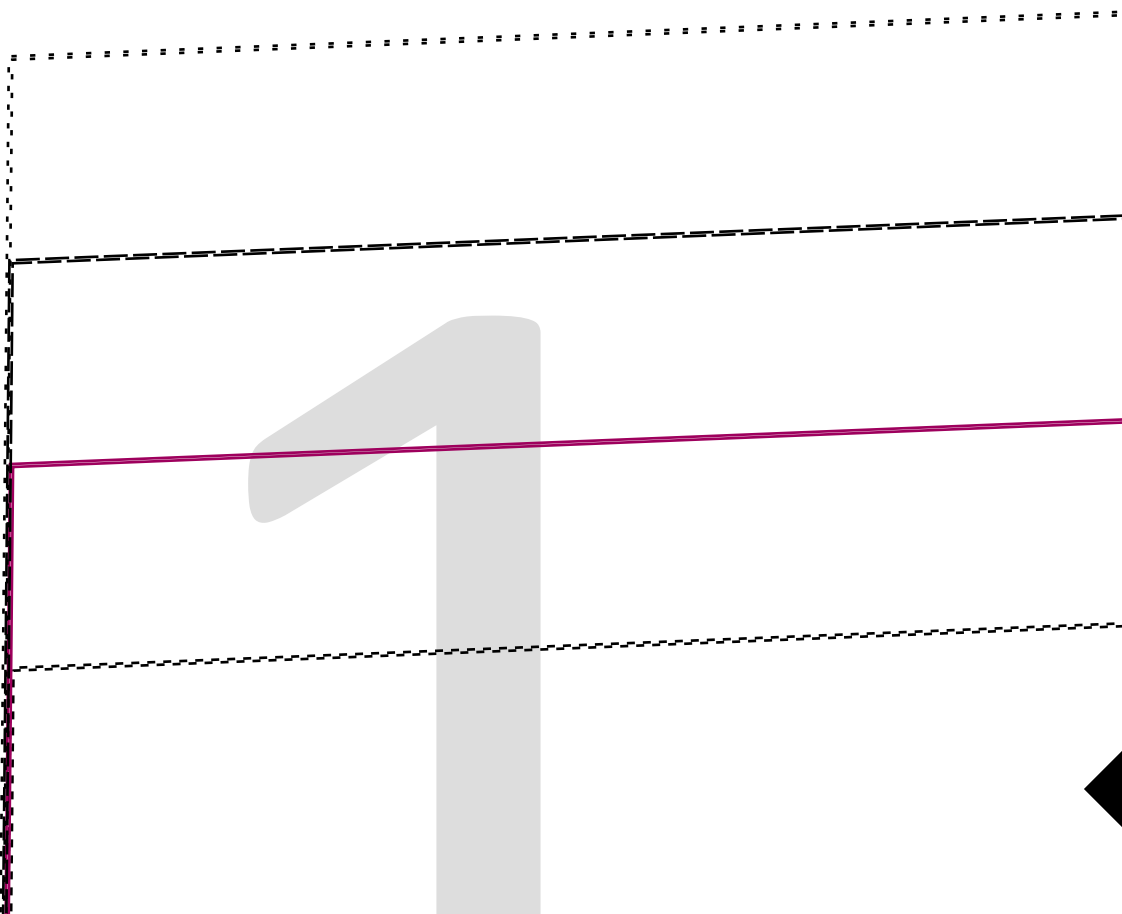

Size	8	10	12	14
Chest	27	28.5	30	31.5

full photo tutorial for putting this all together: <http://nap-timecreations.com/2016/11/the-twirly-dress-free-pdf-pattern.html>

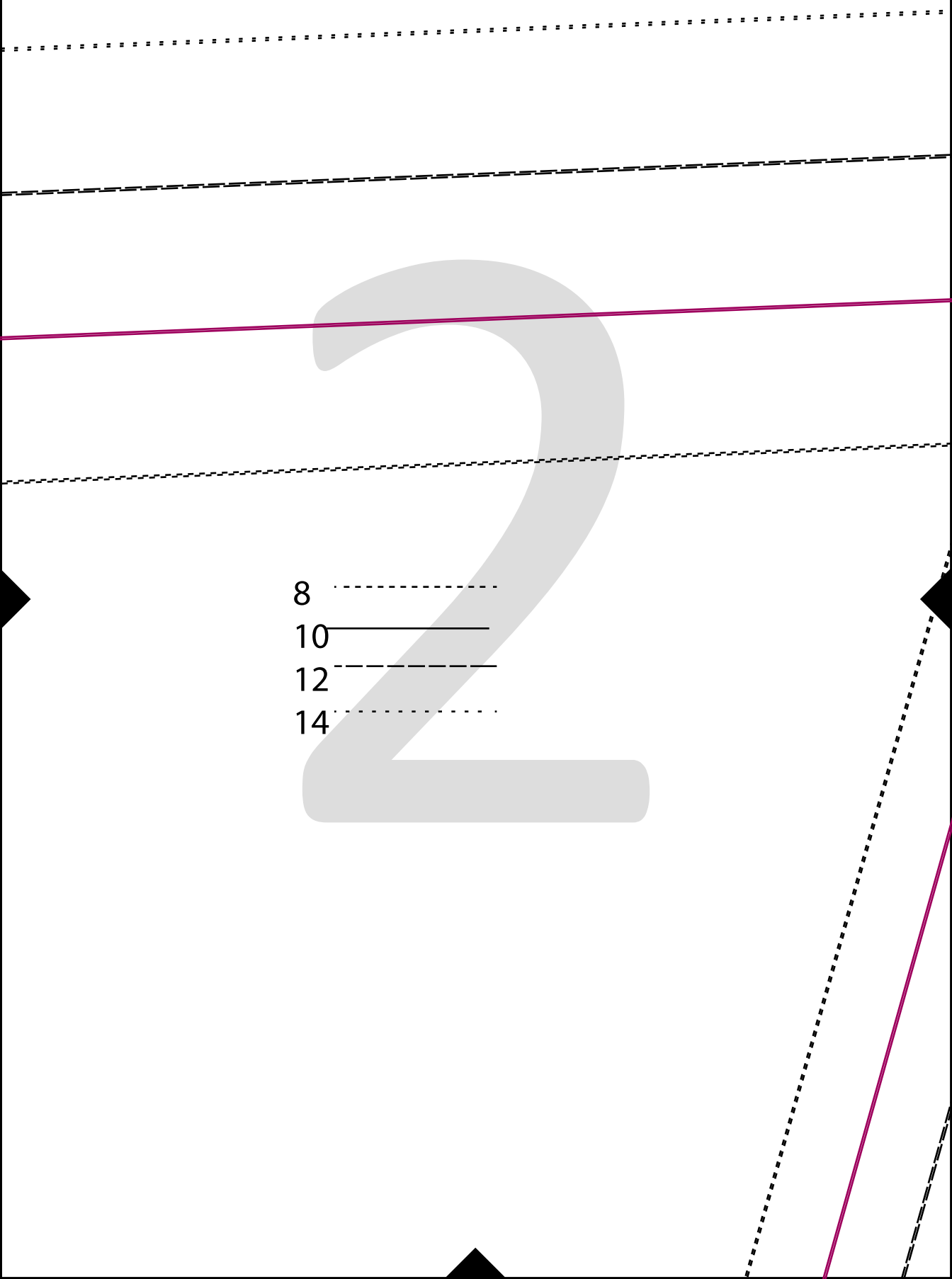

8
10
12
14

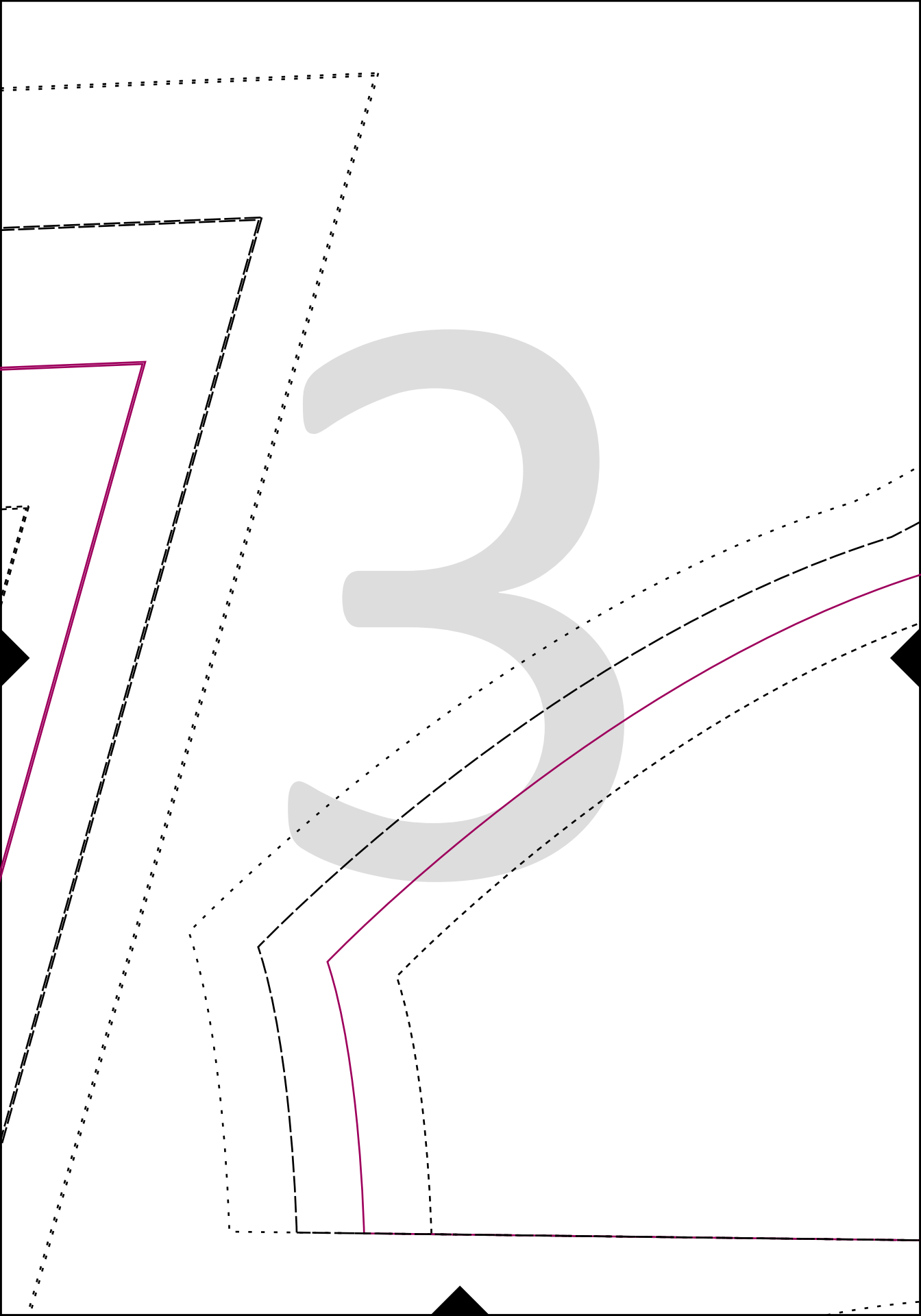

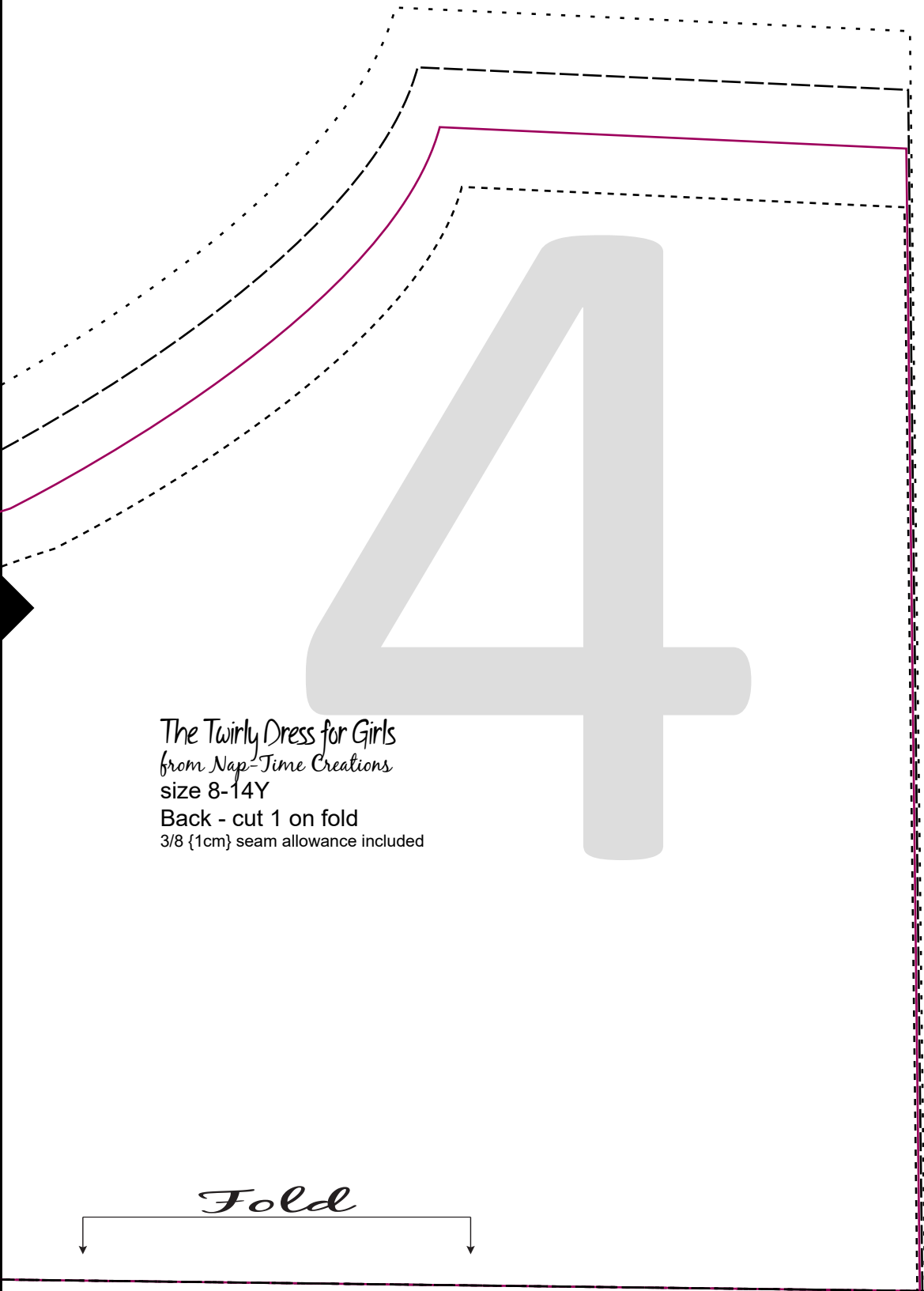

The Twirly Dress for Girls
from Nap-Time Creations
size 8-14Y
Back - cut 1 on fold
3/8 {1cm} seam allowance included

Fold





Fold

The Twirly Dress for Girls
from Nap-Time Creations
size 8-14Y

Dress Front - cut 1 on fold
3/8 {1cm} seam allowance included



6

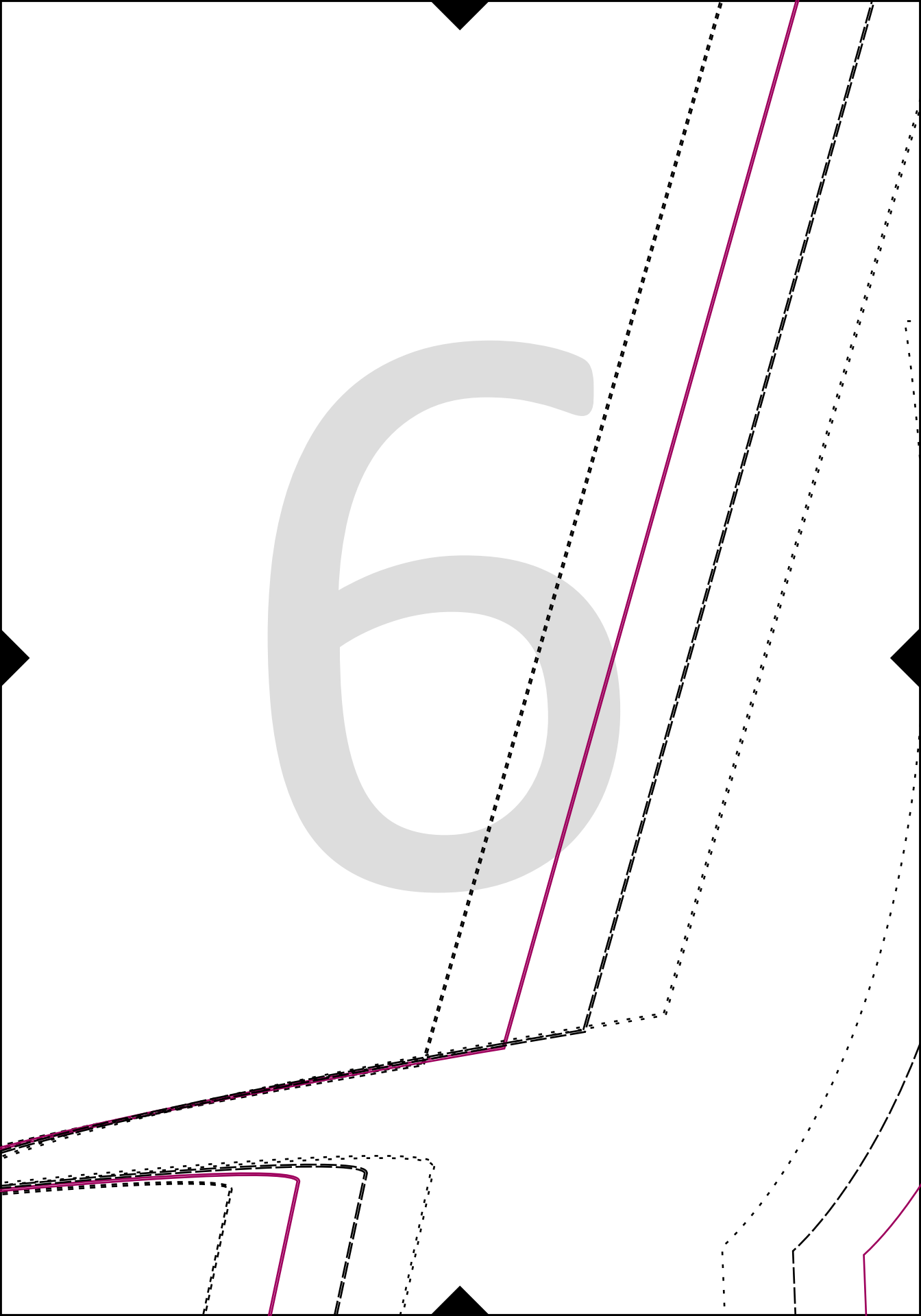

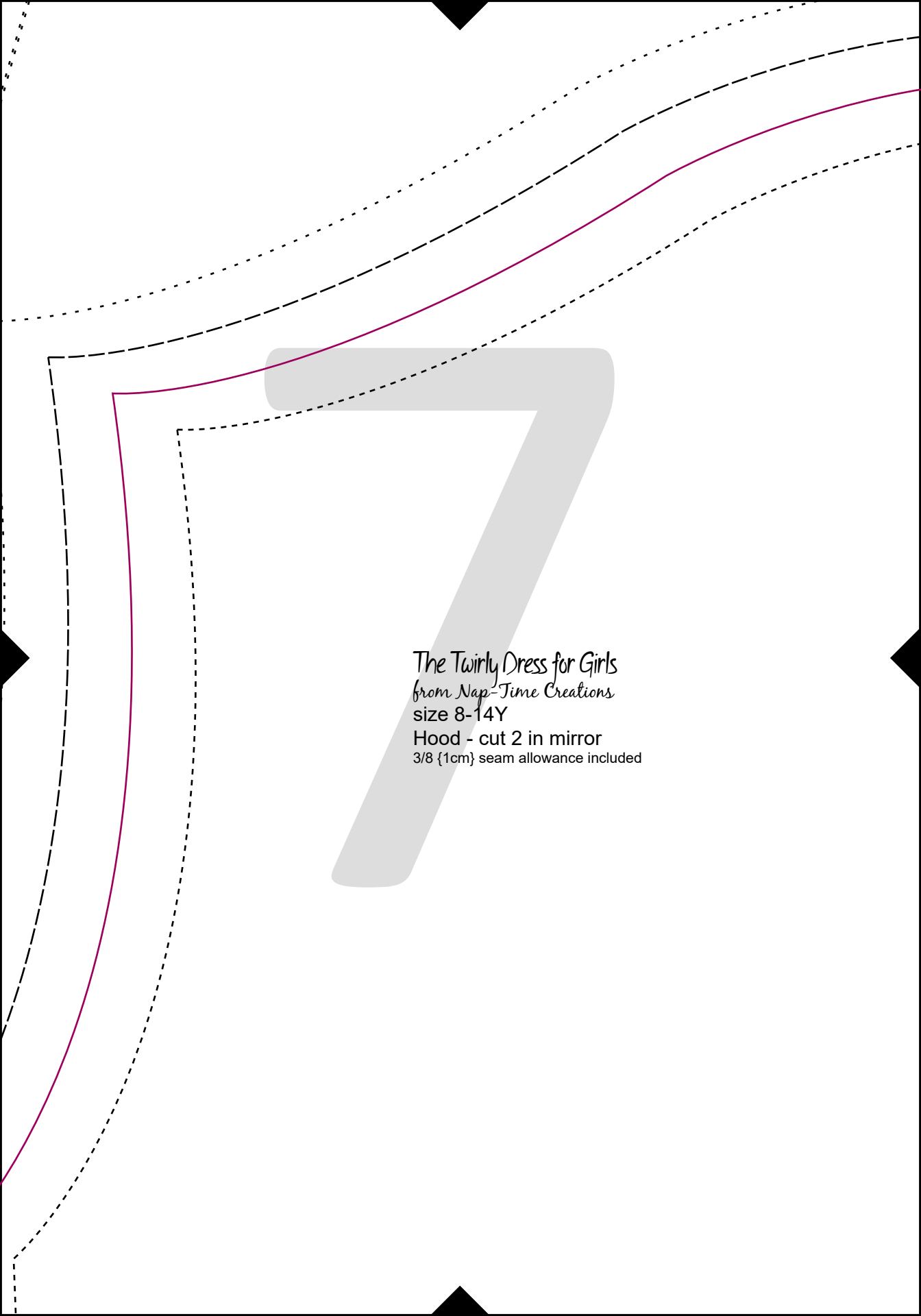

The Twirly Dress for Girls
from Nap-Time Creations
size 8-14Y

Hood - cut 2 in mirror
3/8 {1cm} seam allowance included

8

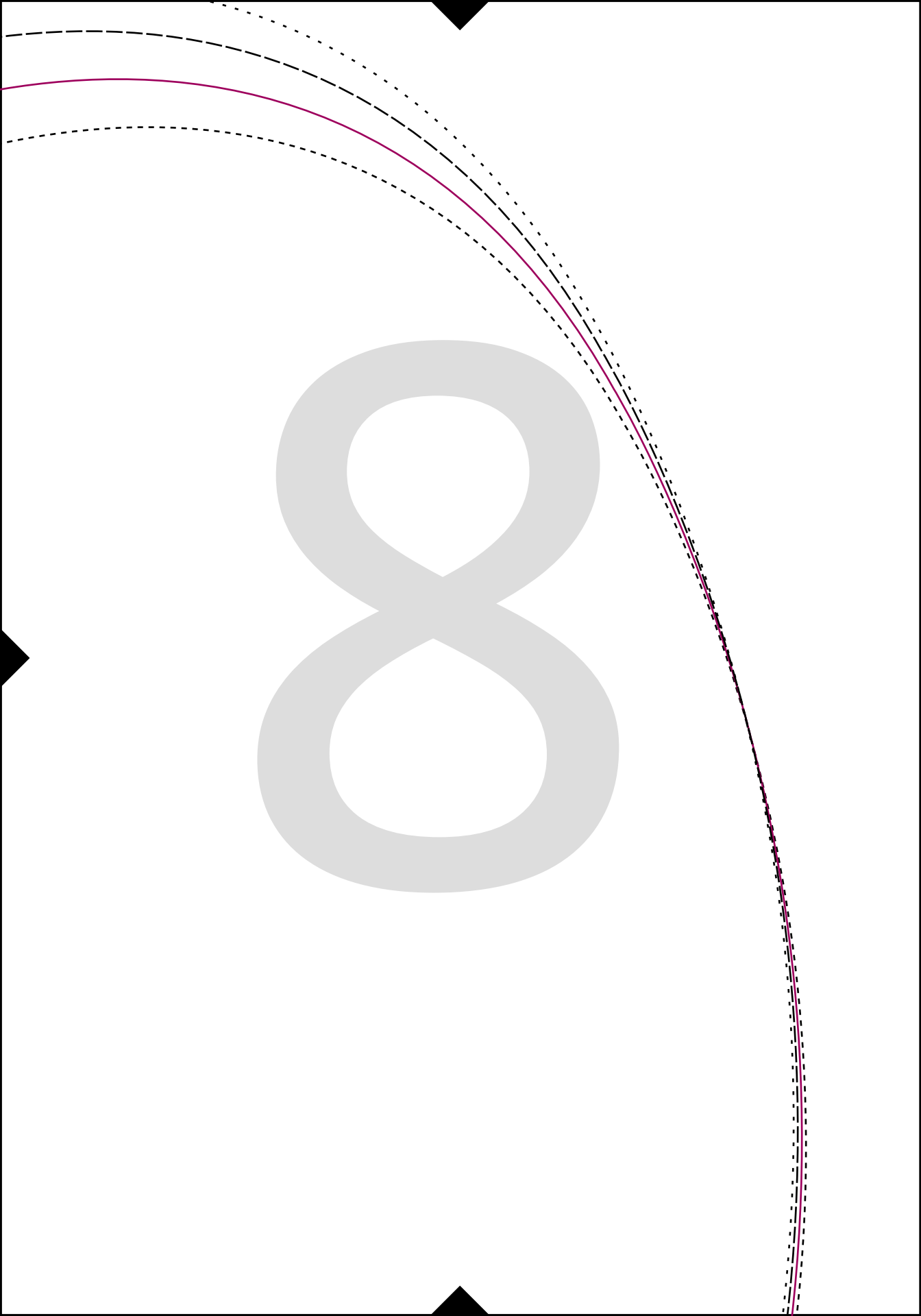

9

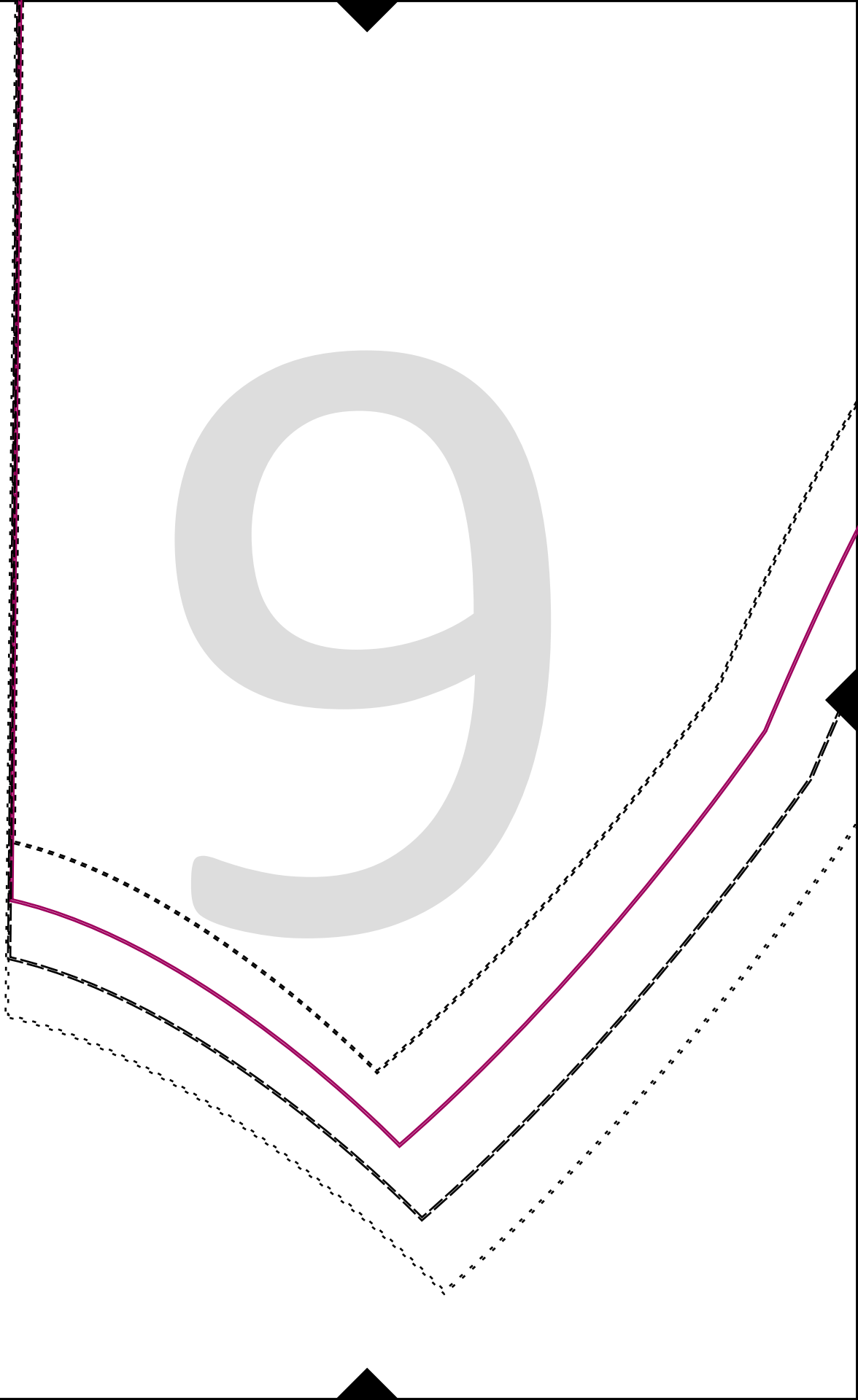

1

0

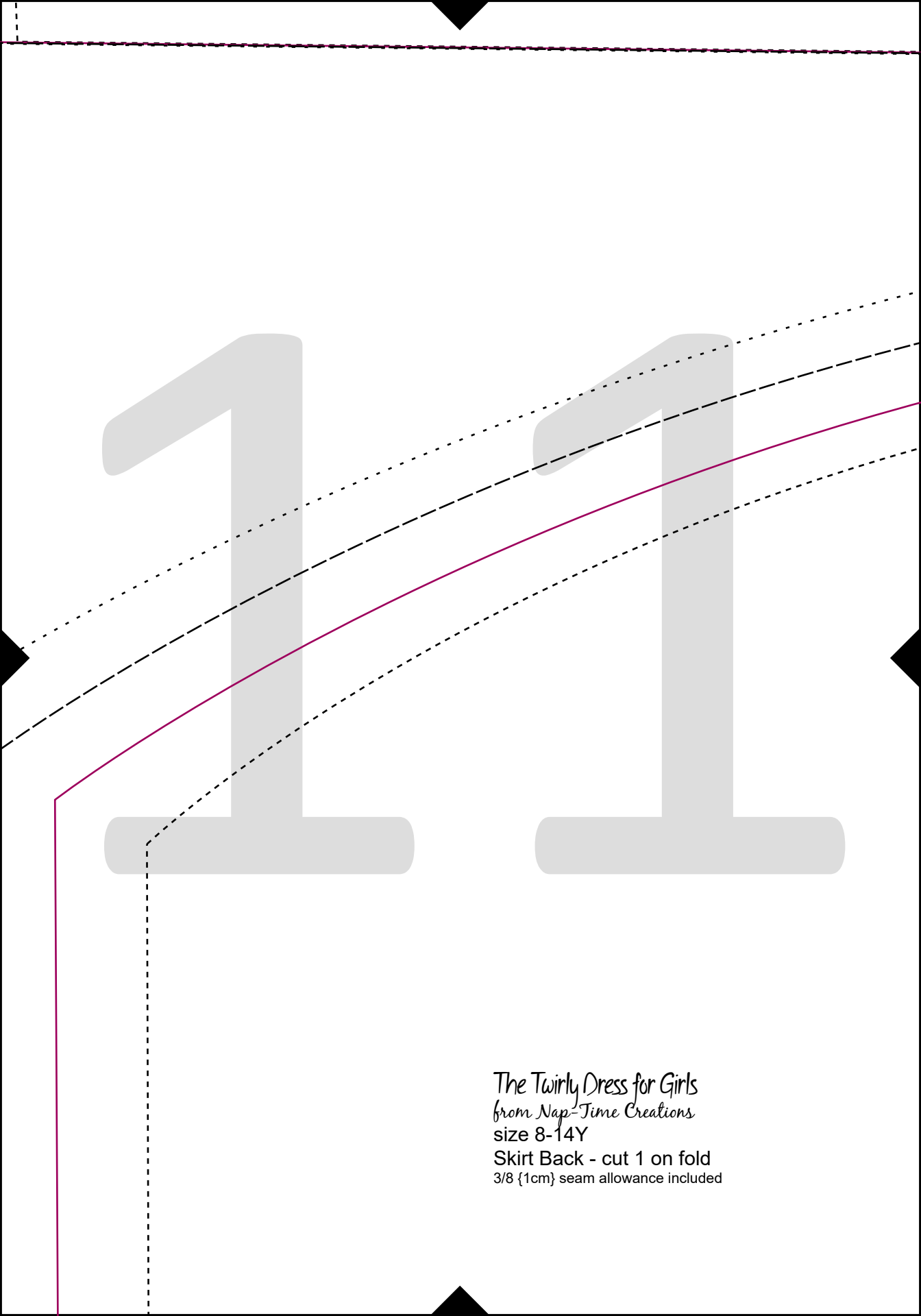

The Twirly Dress for Girls
from Nap-Time Creations
size 8-14Y
Skirt Back - cut 1 on fold
3/8 {1cm} seam allowance included

1

2

1

3

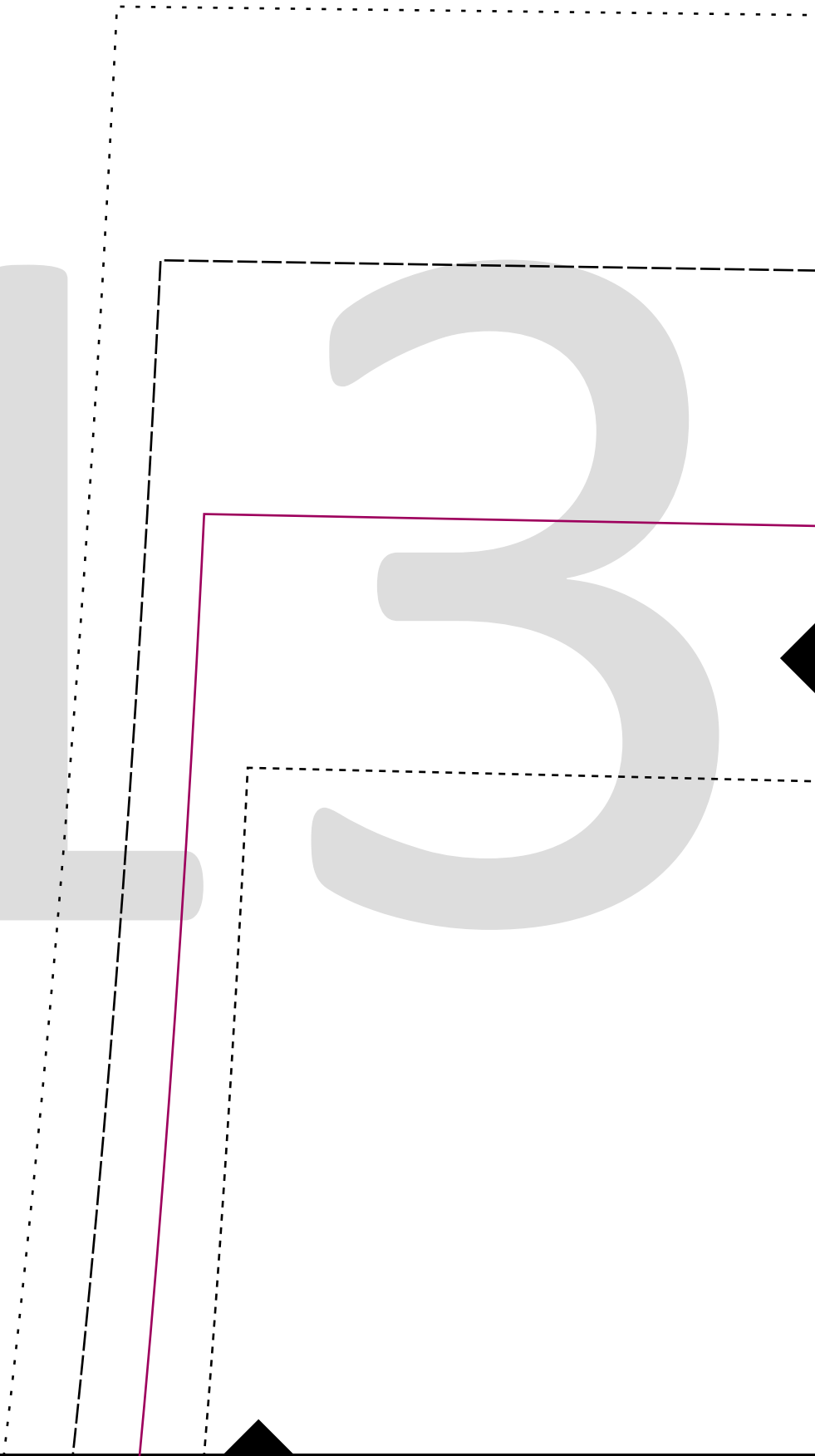

1

4

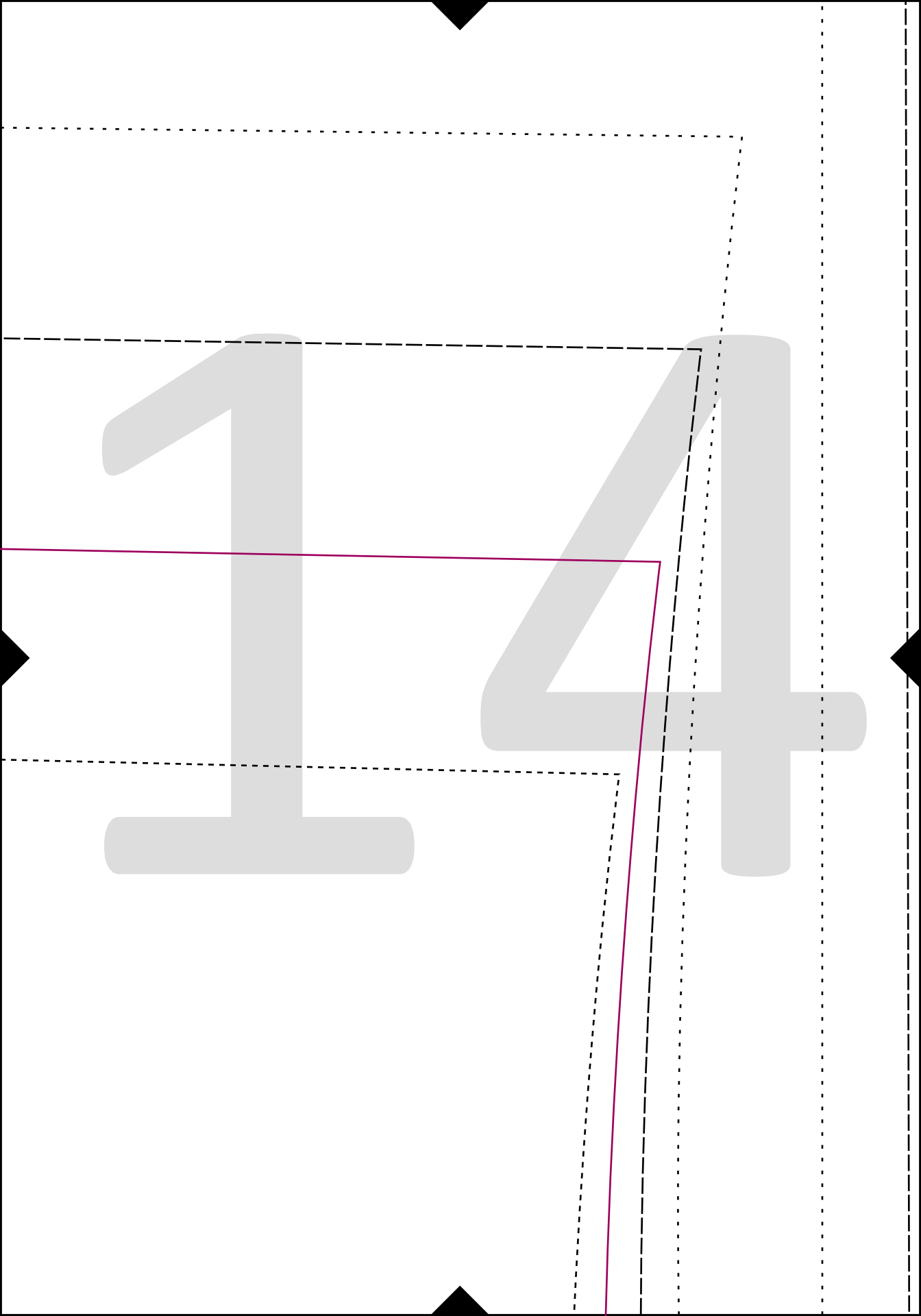

15

1

6

Fold

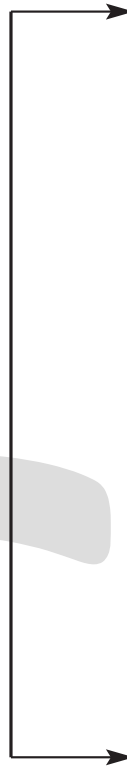

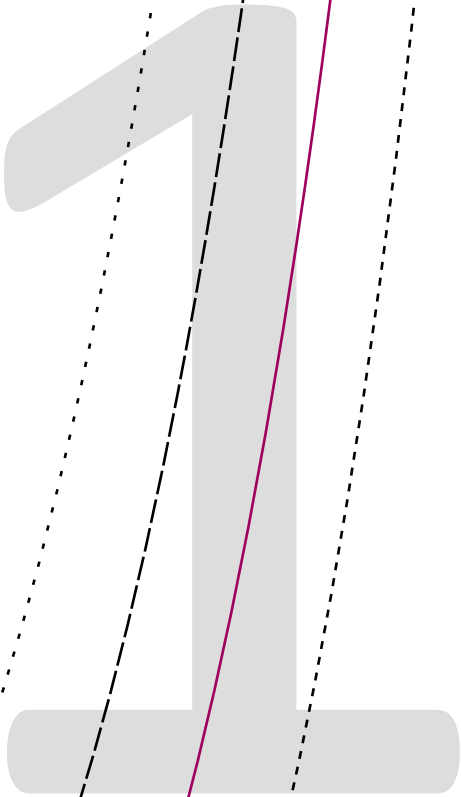

The Twirly Dress for Girls

from Nap-Time Creations

size 8-14Y

Sleeve - cut 2 in mirror

3/8 {1cm} seam allowance included

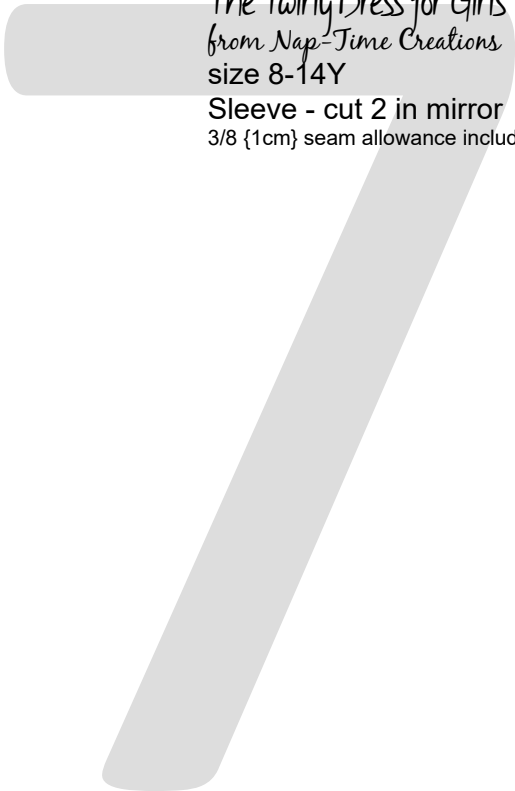

1

8

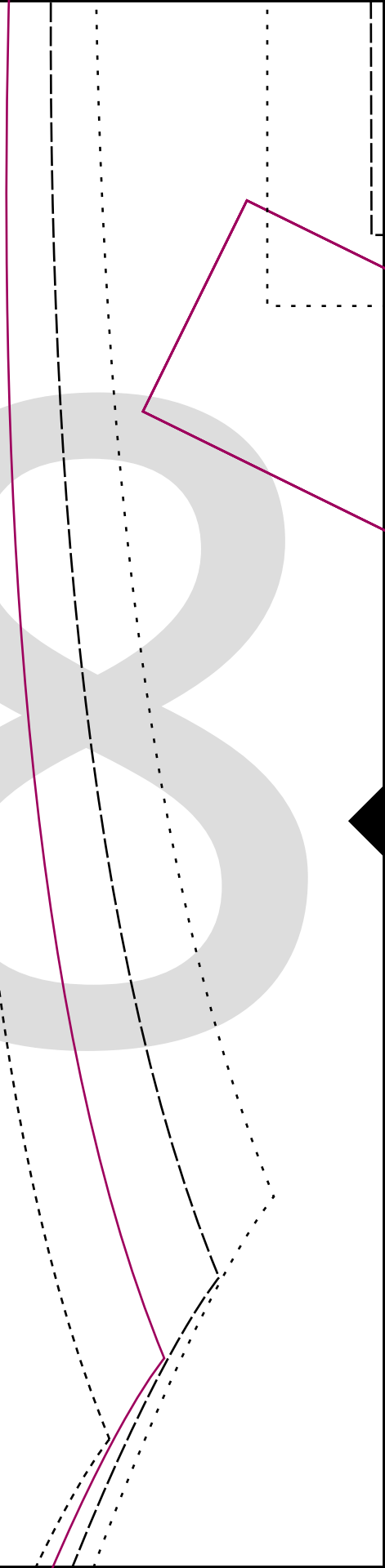

The Twirly Dress for Girls
from Nap-Time Creations
size 8-14Y
Neck Binding - cut 1
3/8 (1cm) seam allowance included

20

--	--	--	--

21

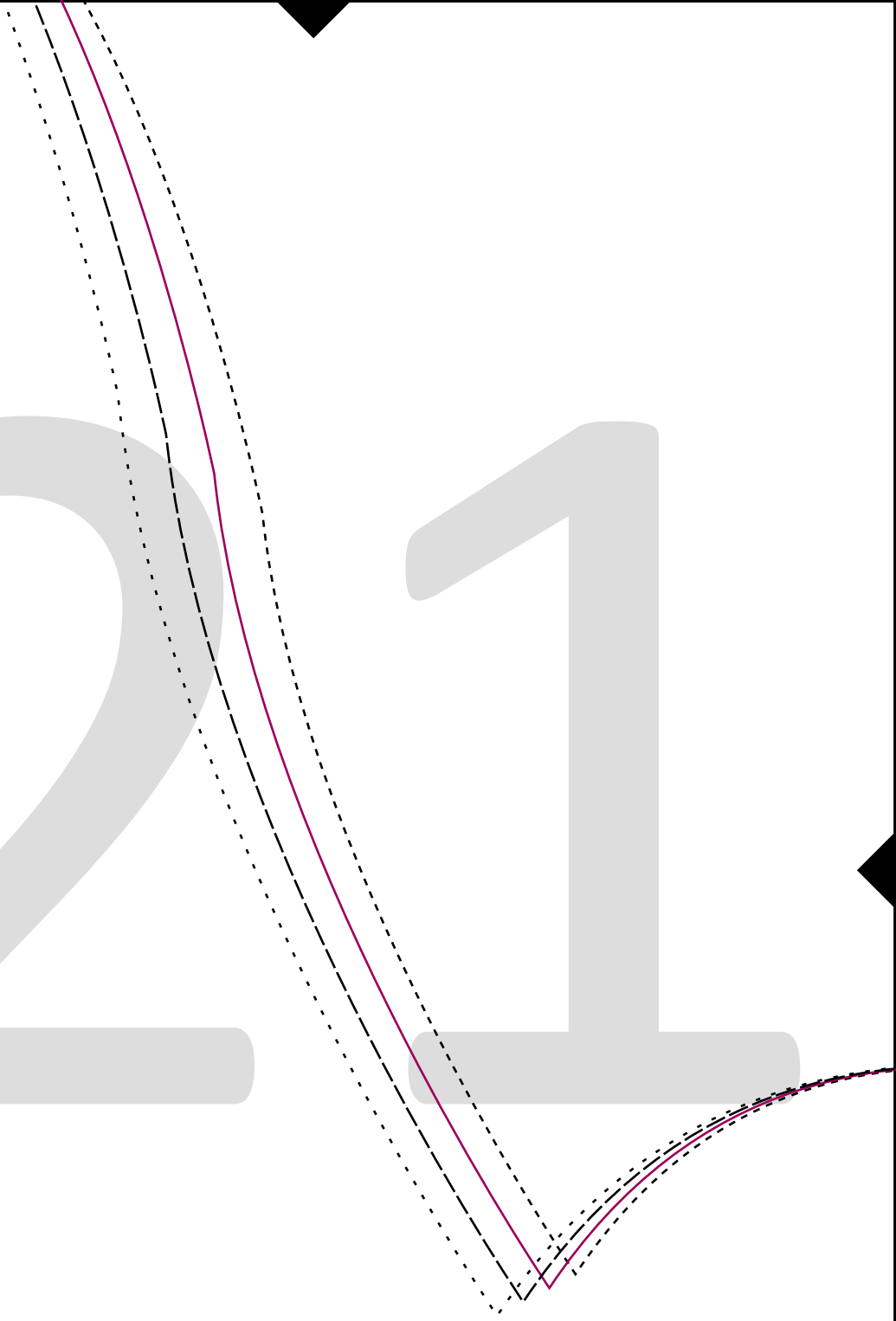

22

22

22