

ID: TEST 5X5CM  
RÓZM: 180-40

WIERSZ 1 KOLUMNA 1  
ROW 1 COLUMN 1

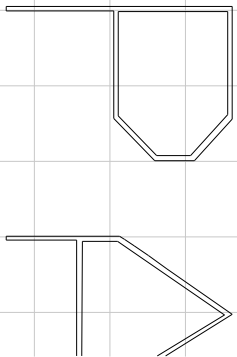
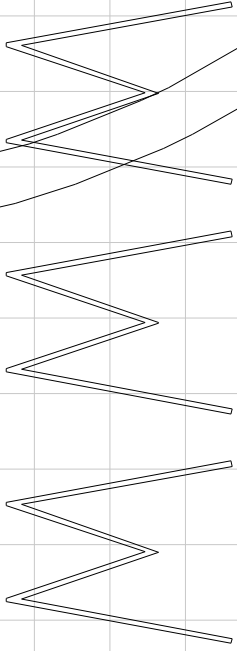

ID: 1 PR

ZOD/FRONT W-BKA-14-02  
ROZM. 180-40

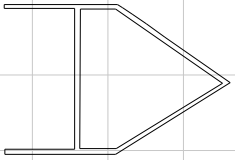
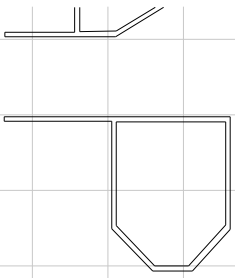

WIERSZ 2 KOLUMNA 1  
ROW 2 COLUMN 1

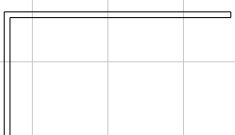
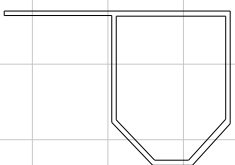
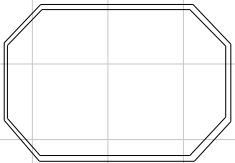
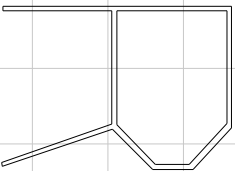
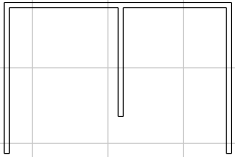

WI ERSZ 3 KOLUMNA 1  
ROW 3 COLUMN 1





WIERSZ 1 KOLUMNA 2  
ROW 1 COLUMN 2

WI ERSZ 2 KOLUMNA 2  
ROW 2 COLUMN 2



WIERSZ 3 KOLUMNA 2  
ROW 3 COLUMN 2

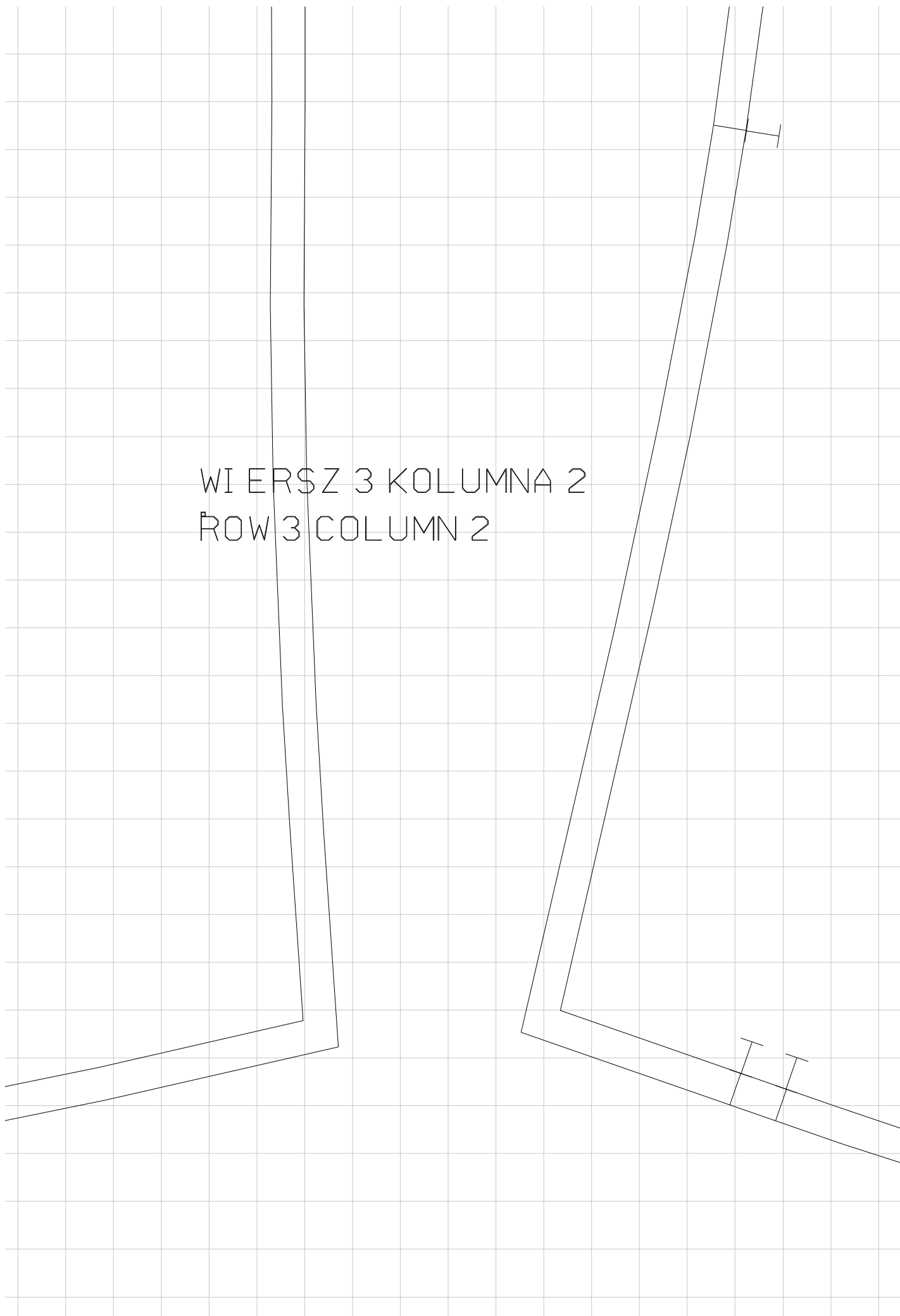

WI ERSZ 2 KOLUMNA 3  
ROW 2 COLUMN 3

---

---

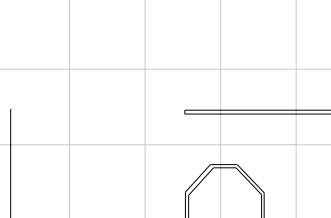

WIERSZ 3 KOLUMN 3  
ROW 3 COLUMN 3

ROZM. 40-40

WWW. PAPA WER. F



WIERSZ 1 KOLUMNA 4  
ROW 1 COLUMN 4

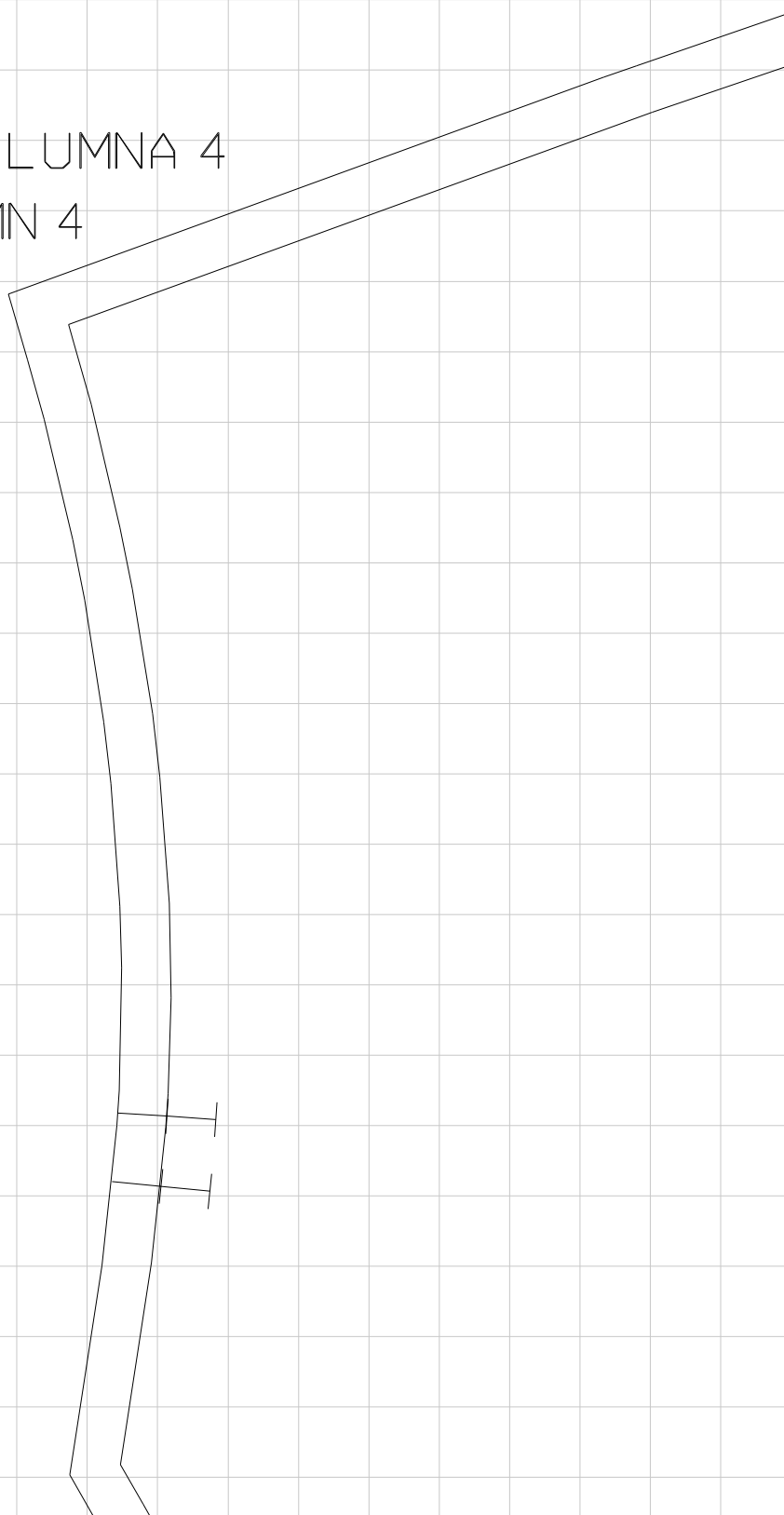

WI ERSZ 2 KOLUMNA 4  
ROW 2 COLUMN 4

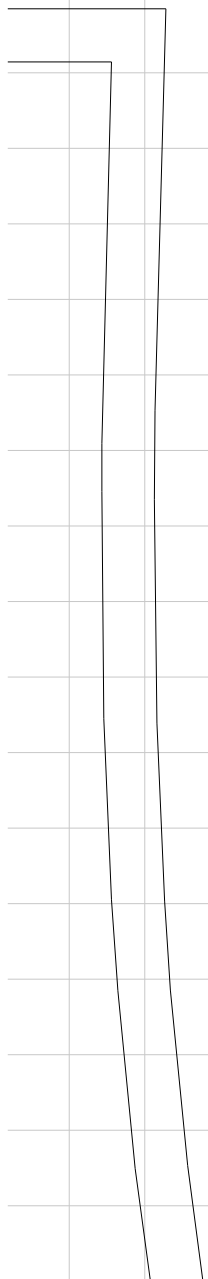



WIERSZ 3 KOLUMNA 4  
ROW 3 COLUMN 4

WIERSZ 1 KOLUMNA 5  
ROW 1 COLUMN 5

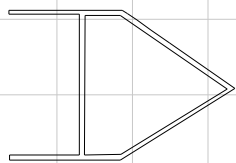
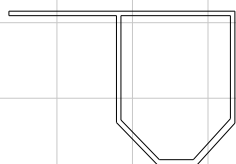
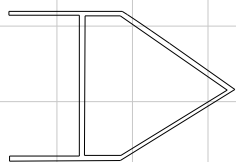
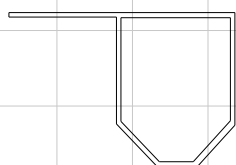

10:2



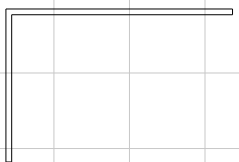
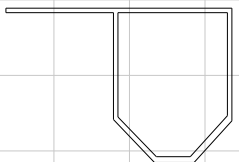
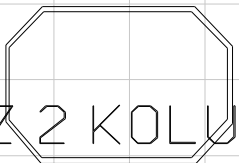
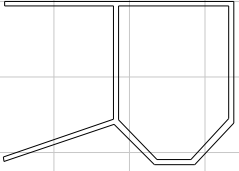
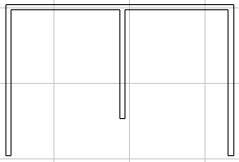

TYL/BACK W-BK  
 ROZM: 180-40  
 WERSZ 2 KOLUMNA 5  
 ROW 2 COLUMN 5  
 14-02

WI ERSZ 3 KOLUMNA 5  
ROW 3 COLUMN 5