

ID: TEST 5X5CM
RÓZM: 180-44

WIERSZ 1 KOLUMNA 1
ROW 1 COLUMN 1

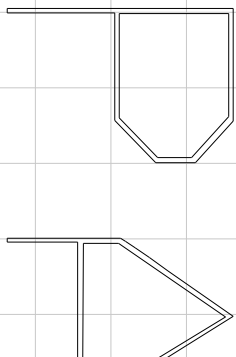

ID: 1 PR

ZODD/FRONT W-BKA-14-02
PROZM: 180-44

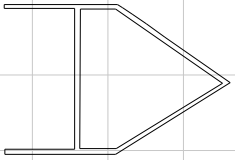
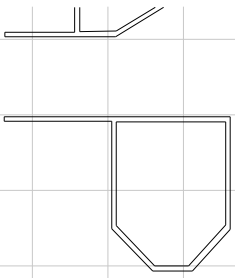

WIERSZ 2 KOLUMNA 1
ROW 2 COLUMN 1

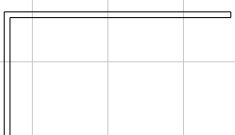
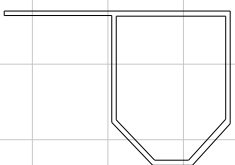
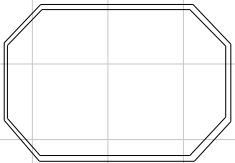
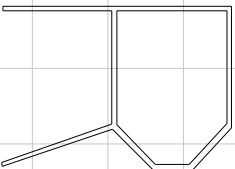
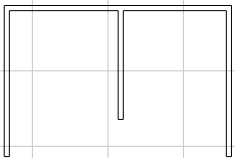

WI ERSZ 3 KOLUMNA 1
ROW 3 COLUMN 1

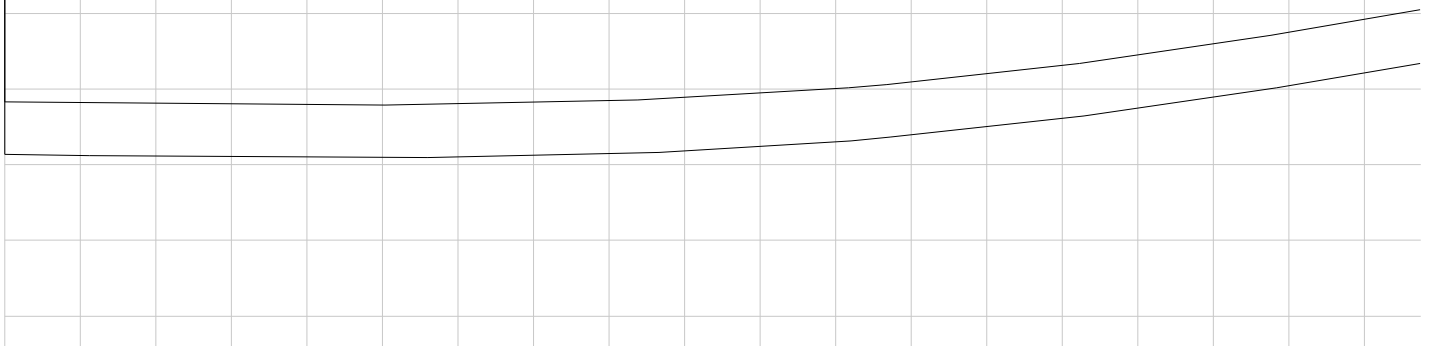

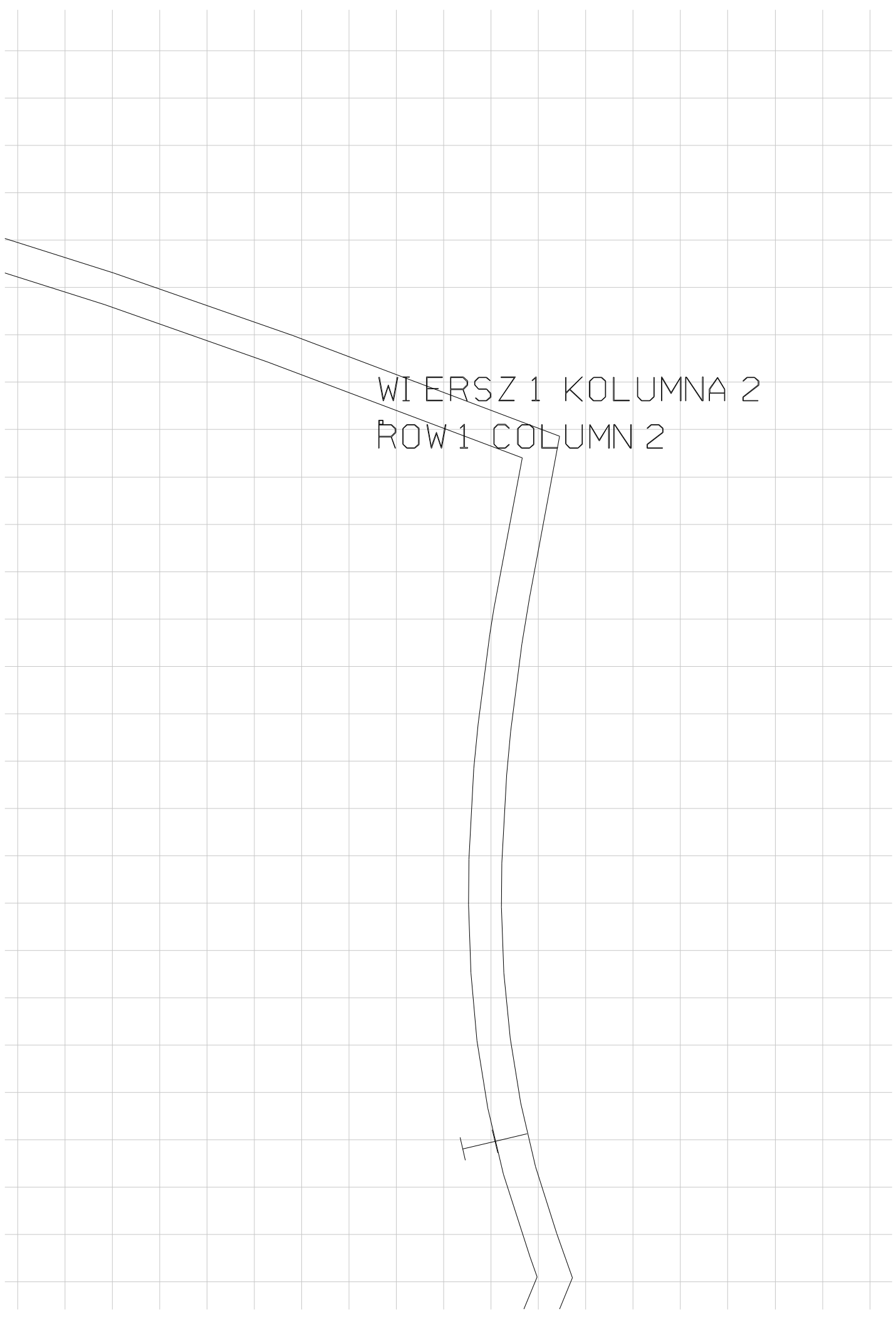

WIERSZ 1 KOLUMNA 2
ROW 1 COLUMN 2

The image shows a technical drawing on a grid. A curved profile is drawn, starting from the left edge and curving downwards and to the right. A dimension line is drawn vertically, indicating a specific measurement. The text 'WIERSZ 1 KOLUMNA 2' and 'ROW 1 COLUMN 2' is written in a monospaced font, with the first line above the second. The drawing is positioned in the upper right quadrant of the grid.

WI ERSZ 2 KOLUMNA 2
ROW 2 COLUMN 2



WI ERSZ 3 KOLUMNA 2
ROW 3 COLUMN 2

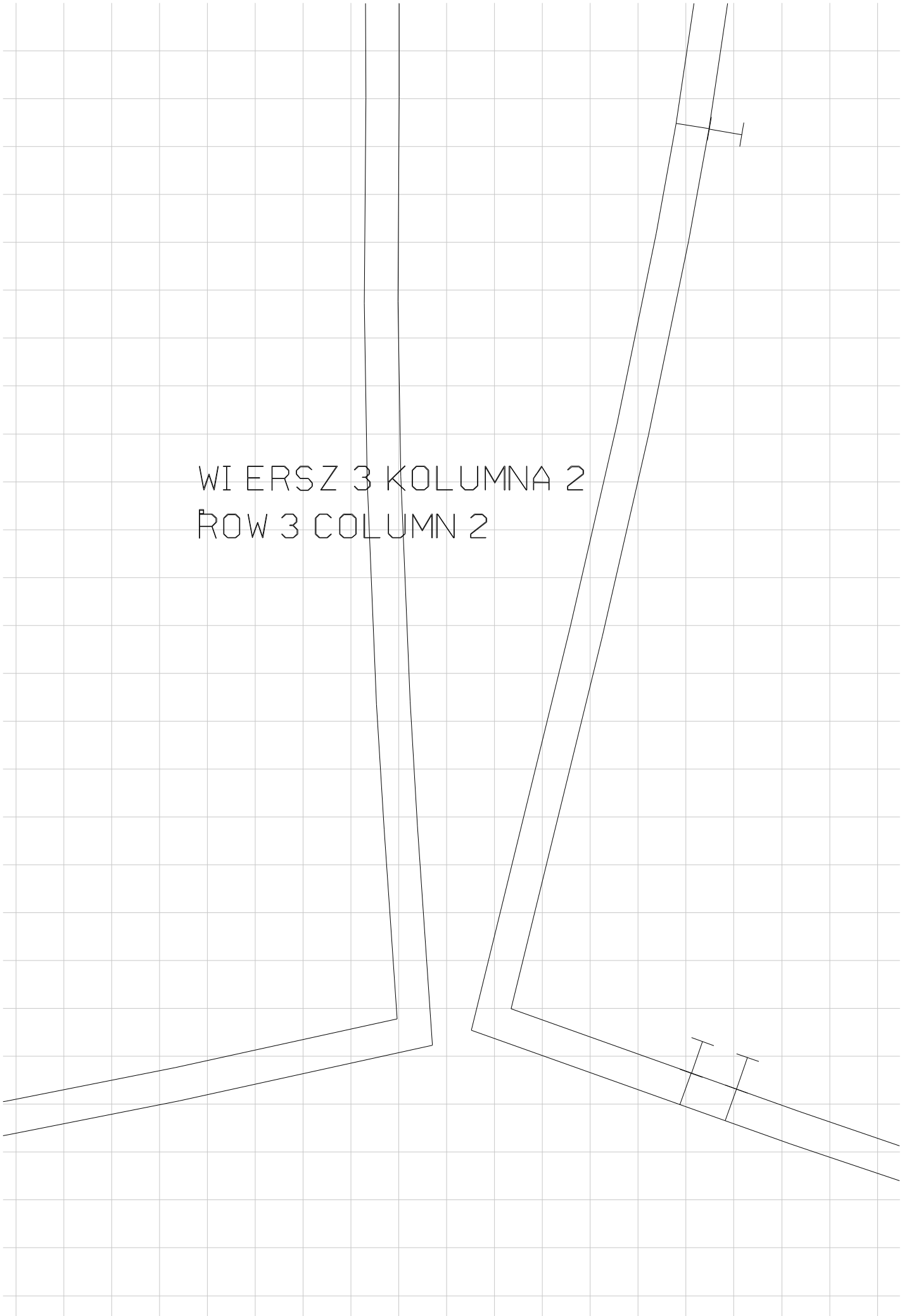

WI ERSZ 2 KOLUMNA 3
ROW 2 COLUMN 3

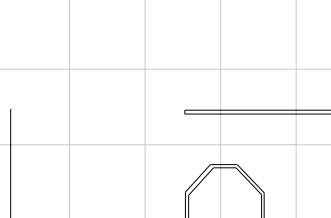

WI ERSZ 3 K O O U M N A 3
R O W 3 C O L U M N 3

ROZM: 10-11

WWW. P A A P A A V E R R O . F

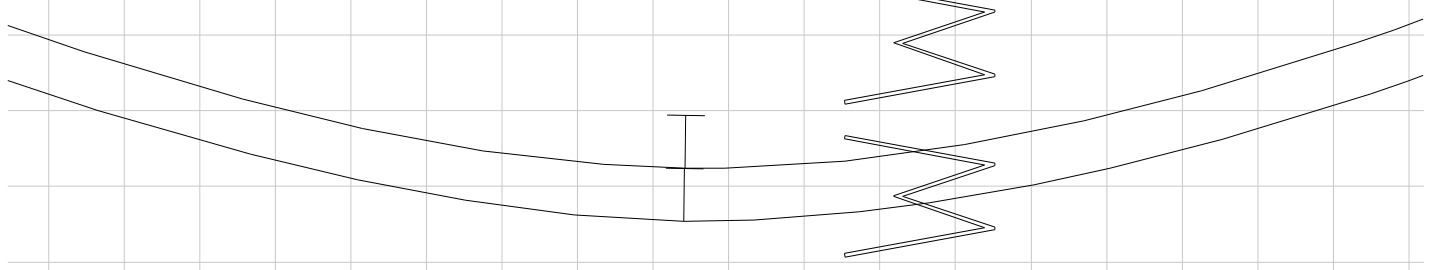

WIERSZ 1 KOLUMNA 4
ROW 1 COLUMN 4

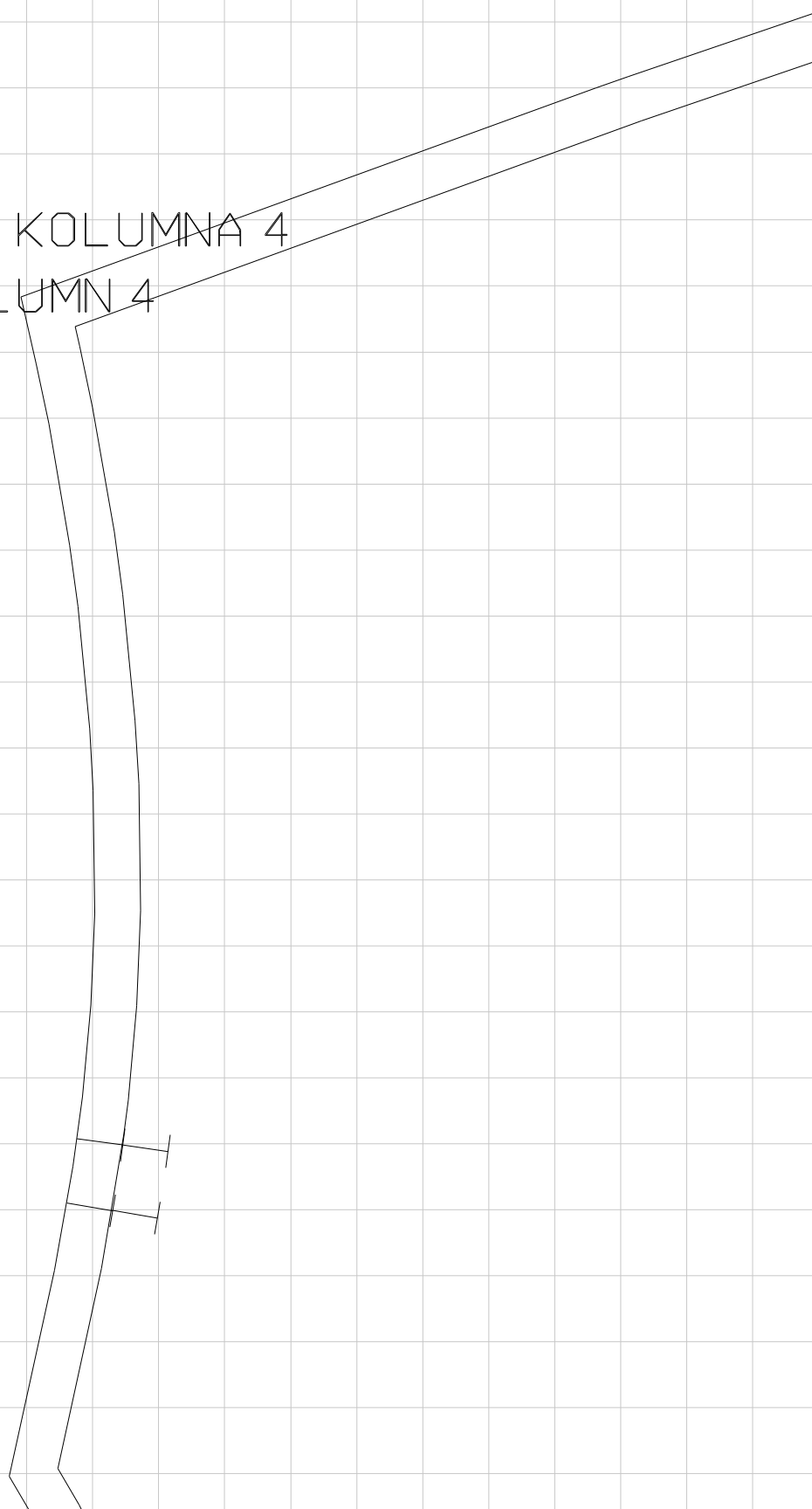

WI ERSZ 2 KOLUMNA 4
ROW 2 COLUMN 4

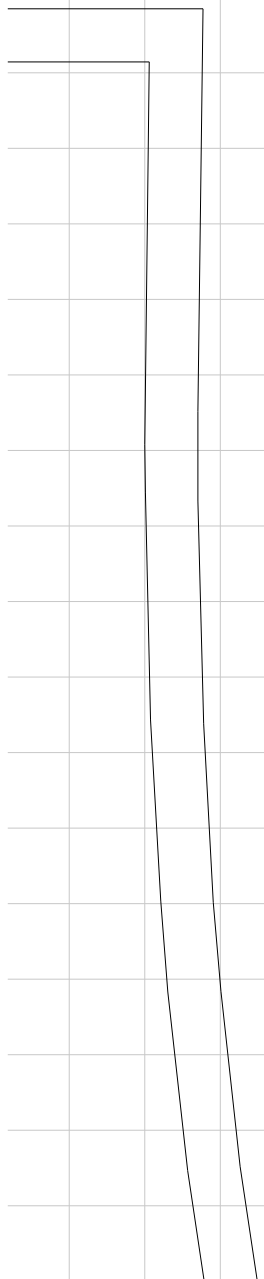



WIERSZ 3 KOLUMNA 4
ROW 3 COLUMN 4

WIERSZ 1 KOLUMNA 5
ROW 1 COLUMN 5

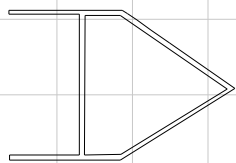
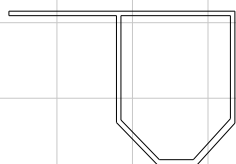
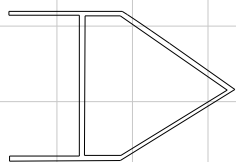
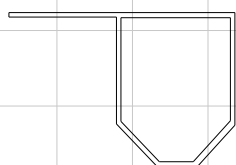

ID: 2



/

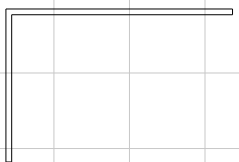
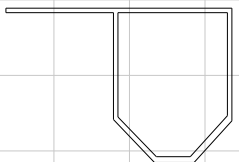
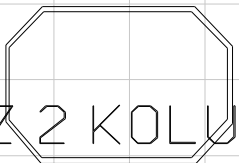
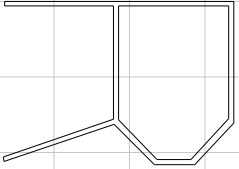
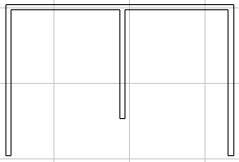

TYL/BACK W BKA
ROZM. 180-4
WERSZ 2 KOLUMNA 5
ROW 2 COLUMN 5
14-02

WI ERSZ 3 KOLUMNA 5
ROW 3 COLUMN 5