

ROZMIAR: 42

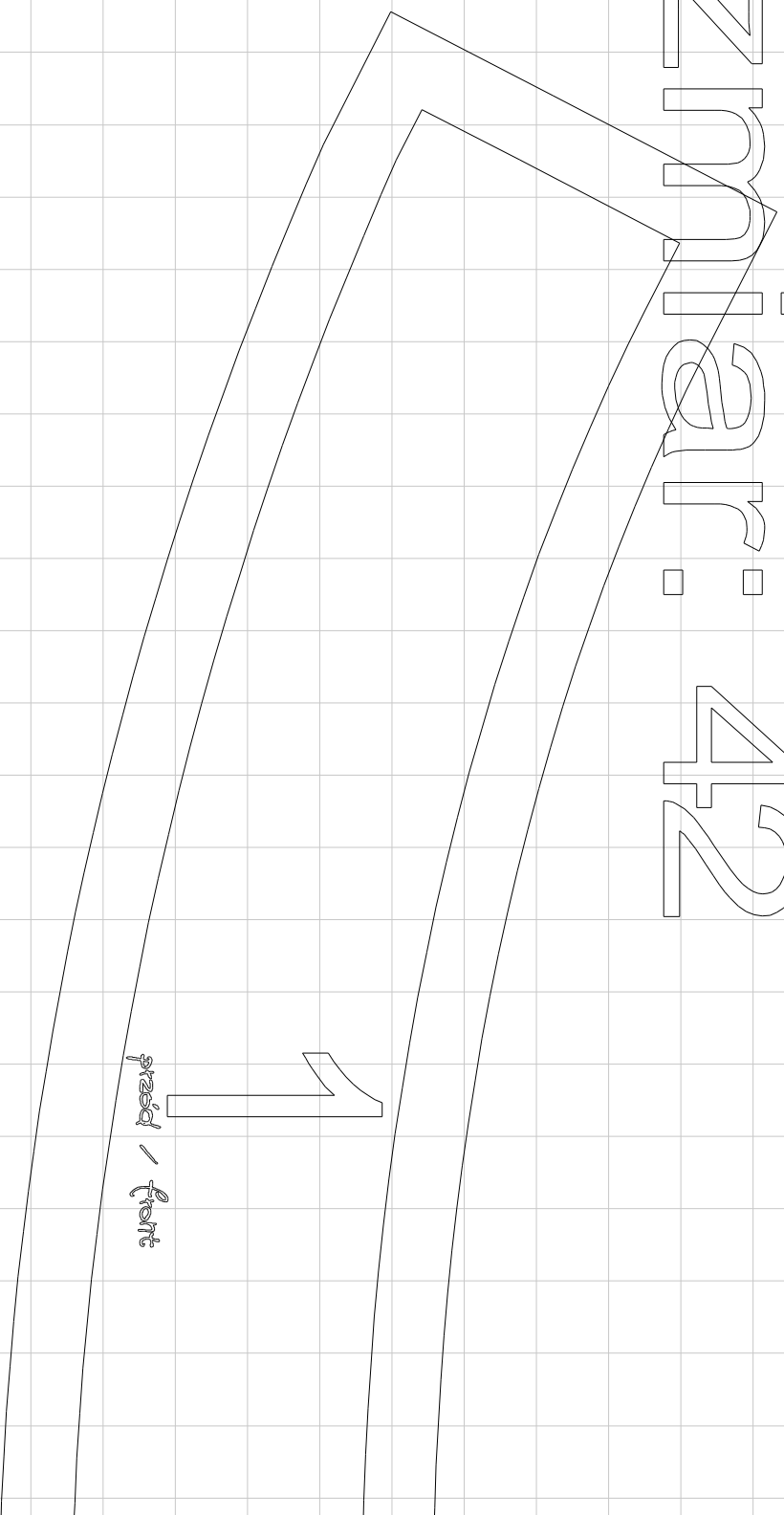

kolumna 1 wiersz 1

5x5 cm

test

wysca 1232

wzrost/height 168 cm

kolumna 1 wiersz 2

kolumna 1 wiersz 3

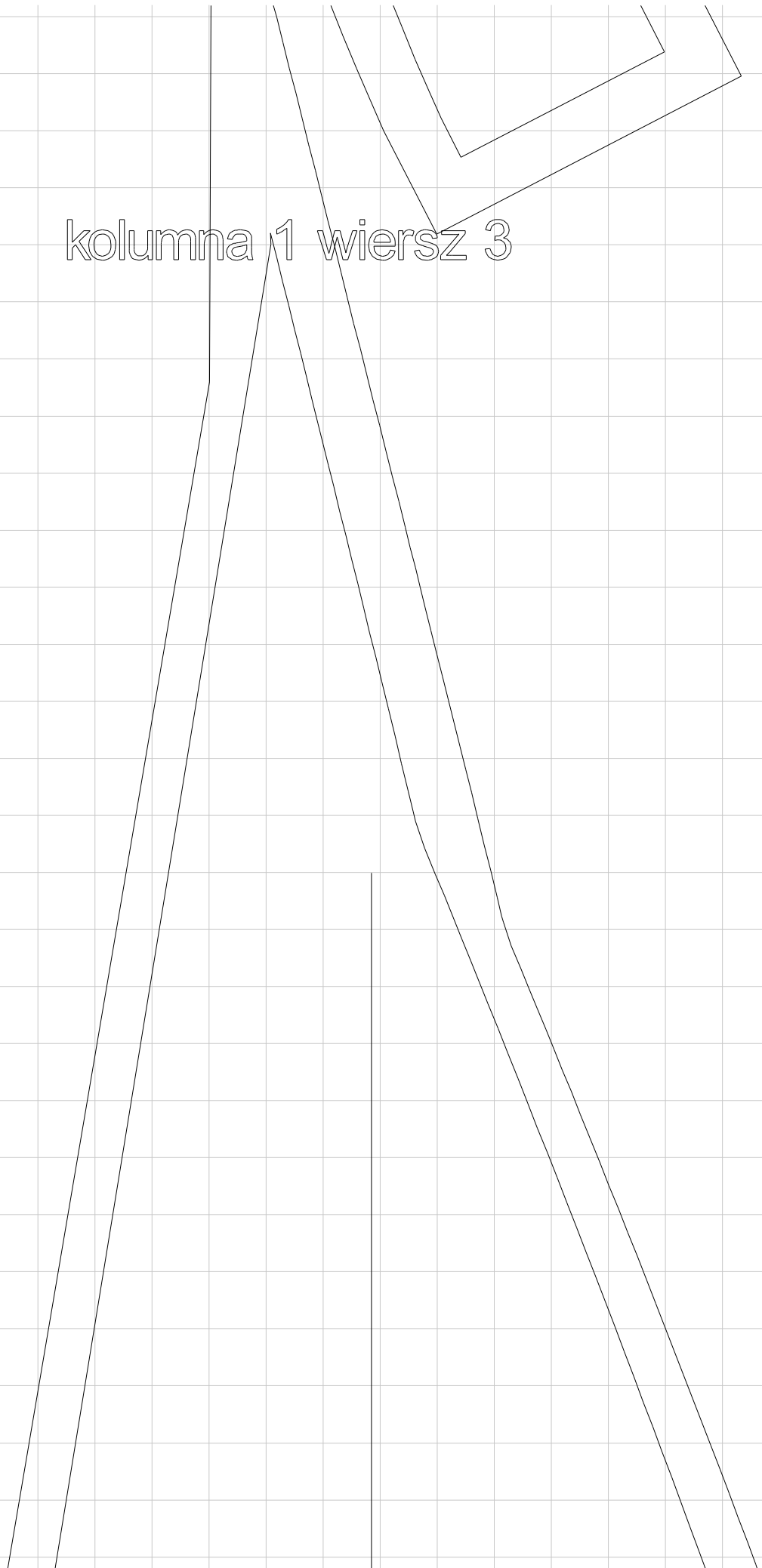

kolumna 1 wiersz 4

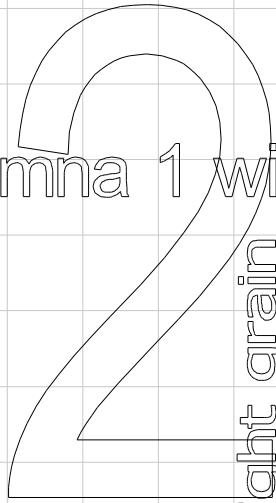

przód

straight grain

nitka prosta
przód

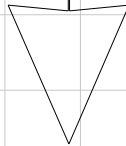

kolumna 2 wiersz 1

3
przód /

5

6

kolumna 2 wiersz 2

ight grain

strai

kolumna 2 wiersz 3

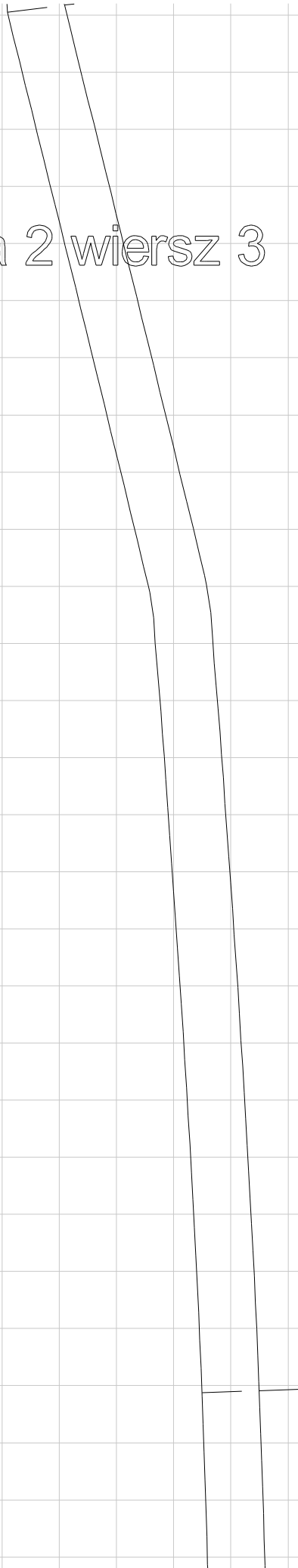

kolumna 2 wiersz 4

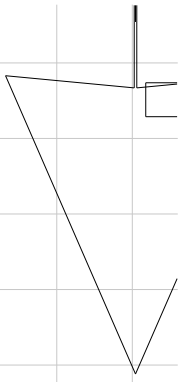
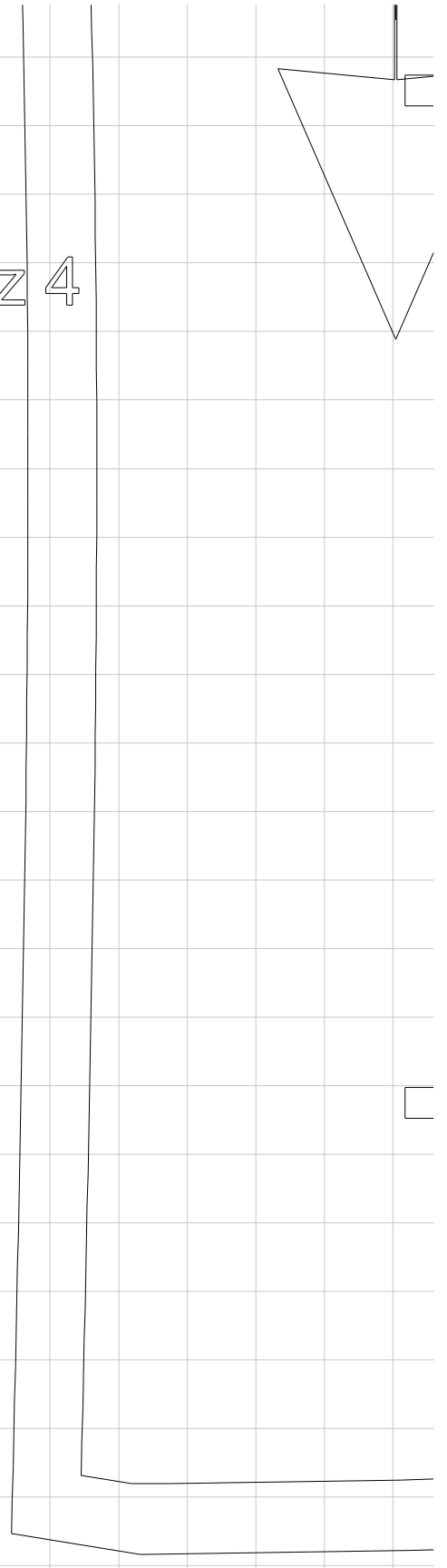
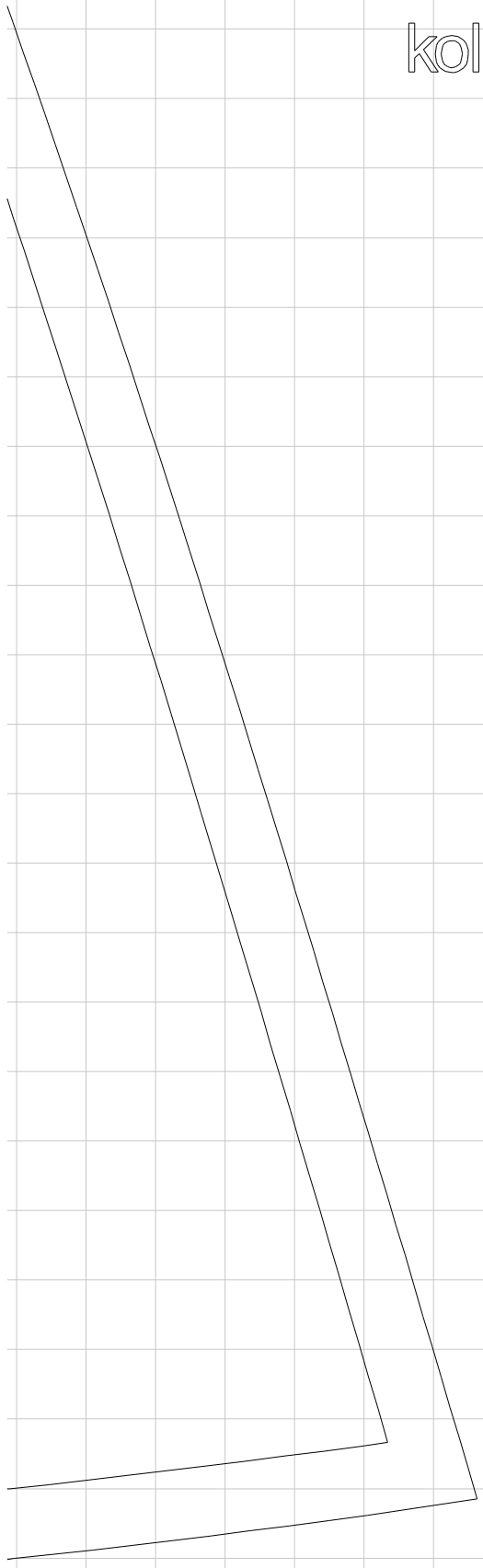

kolumna 3 wiersz 1

)

)

front

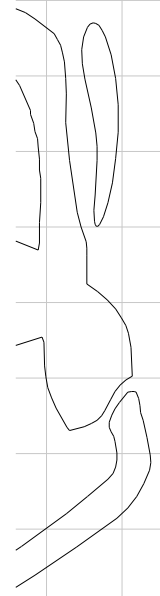

kolumna 3 wiersz 2

nitka por

osta

kolumna 3 wiersz 3

WVWV-DC
©

Di. 20. 11

kolumna 3 wiersz 4

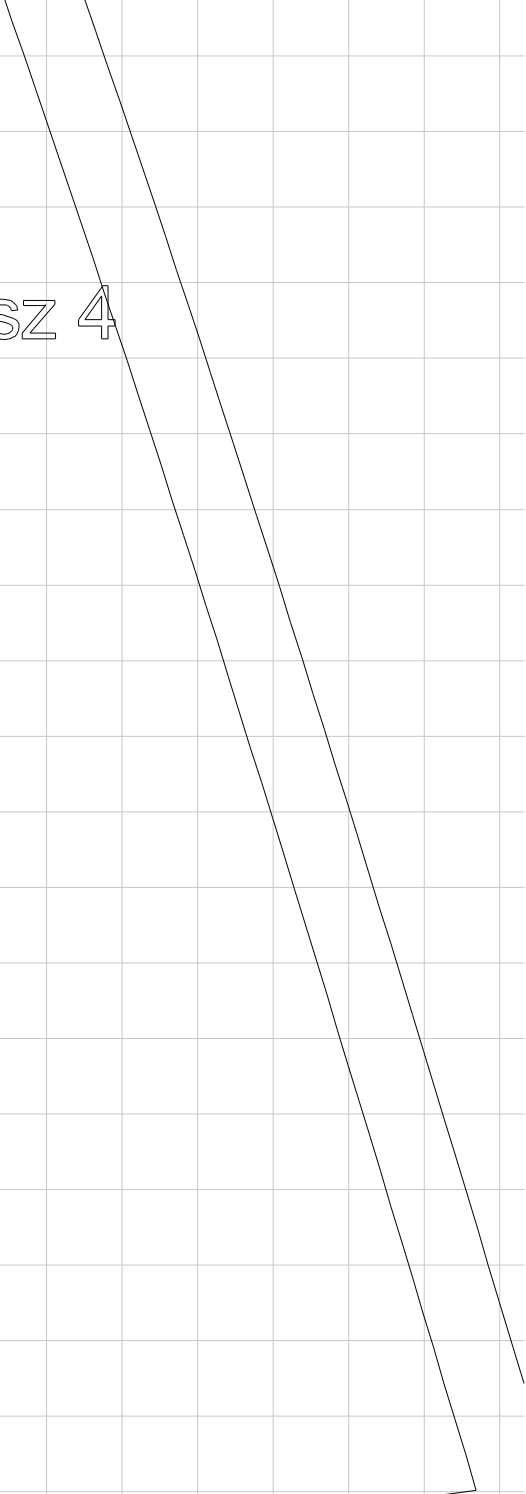

kolumna 4 wiersz 1

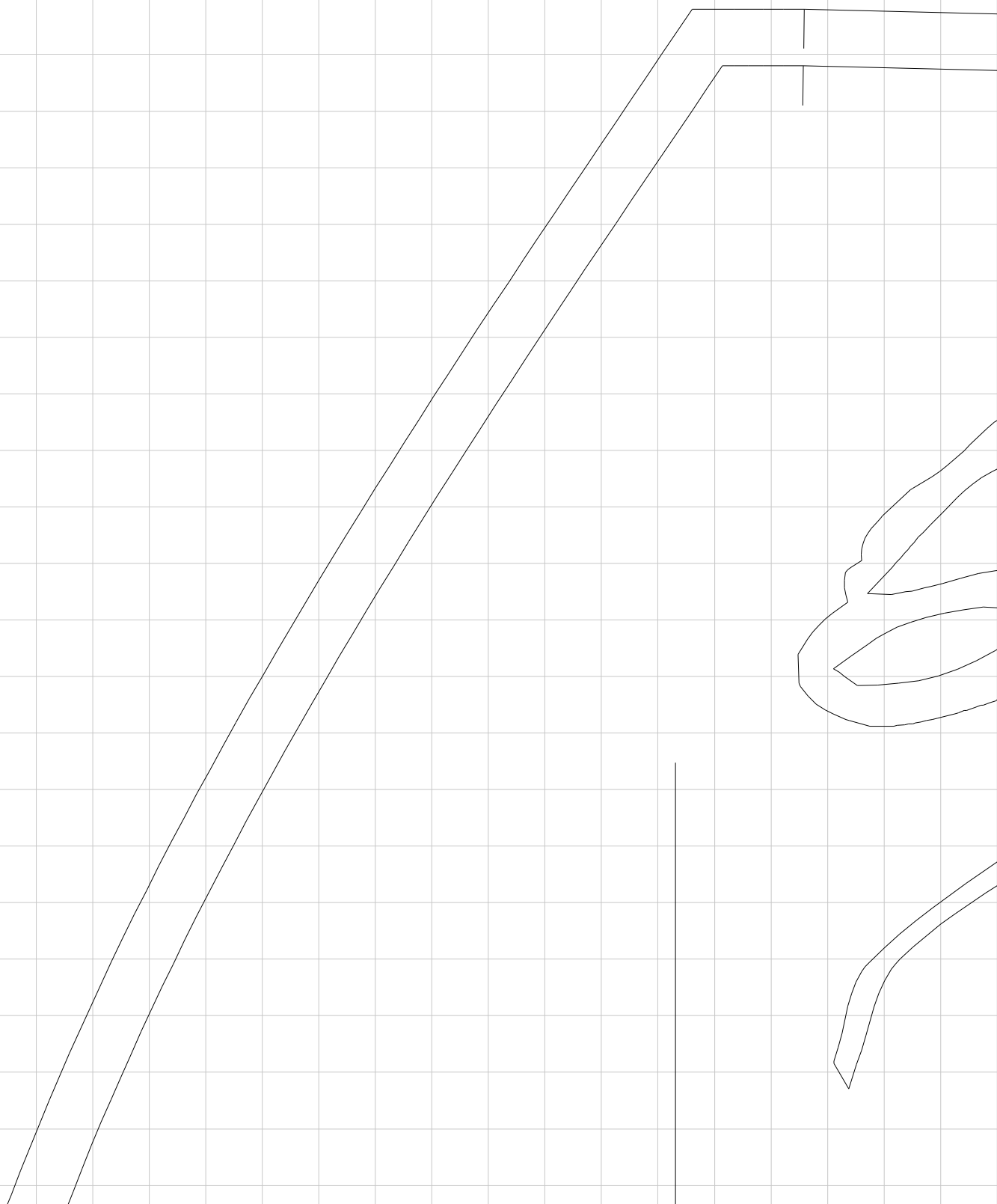

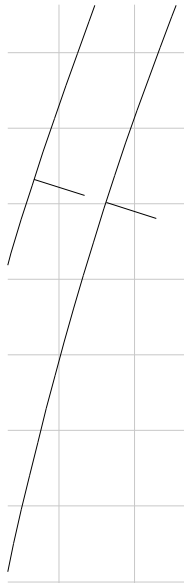

kolumna 4 wiersz 2

sdie:www

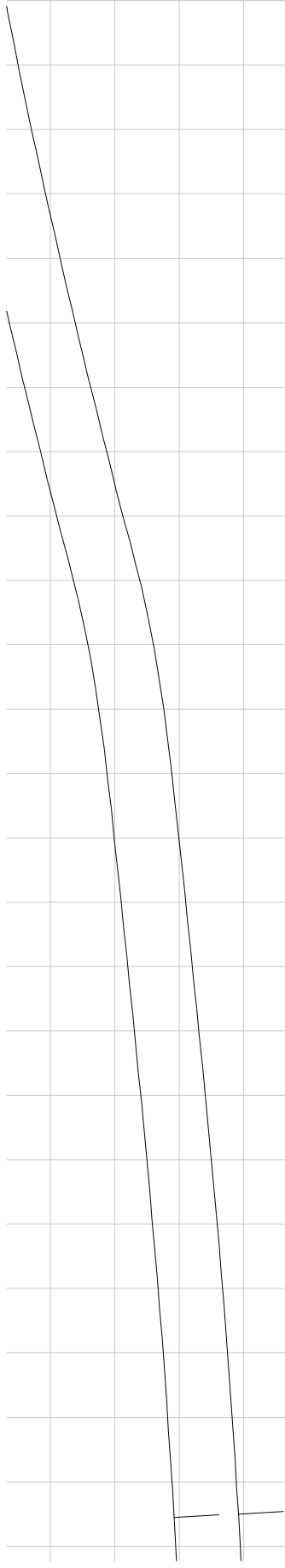

id. OJEA

kolumna 4 wiersz 3

straight grain

nitke prostea

kolumna 4 wiersz 4

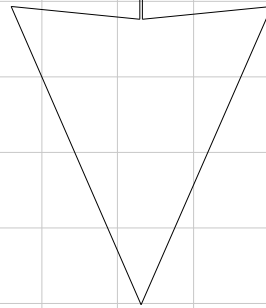

kolumna 5 wiersz 1

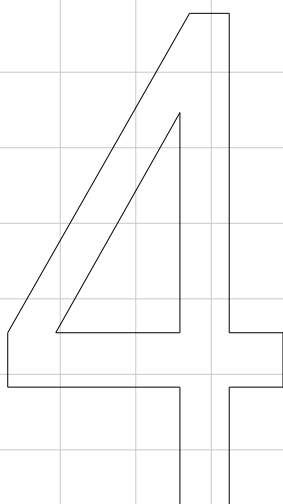

przód / front

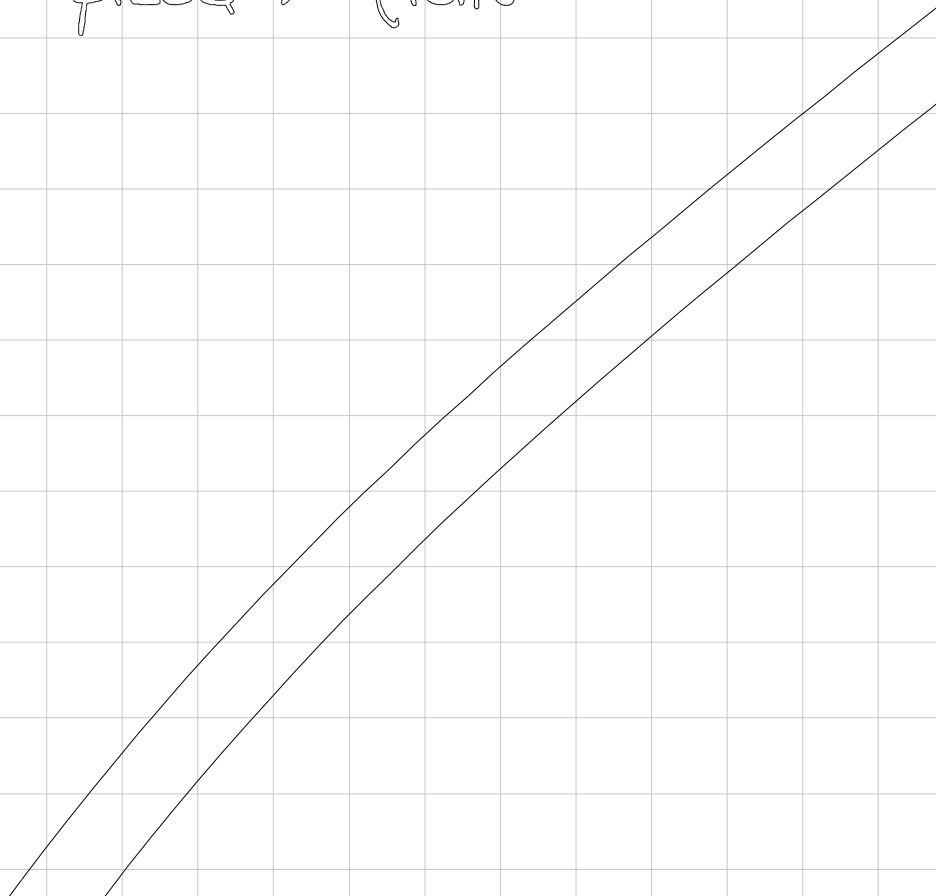
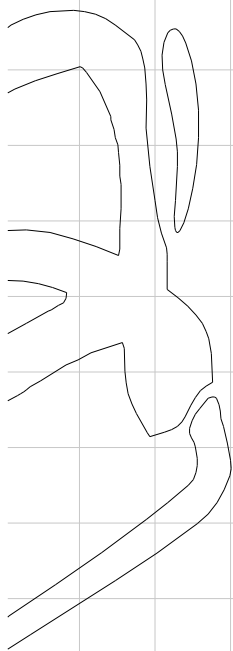

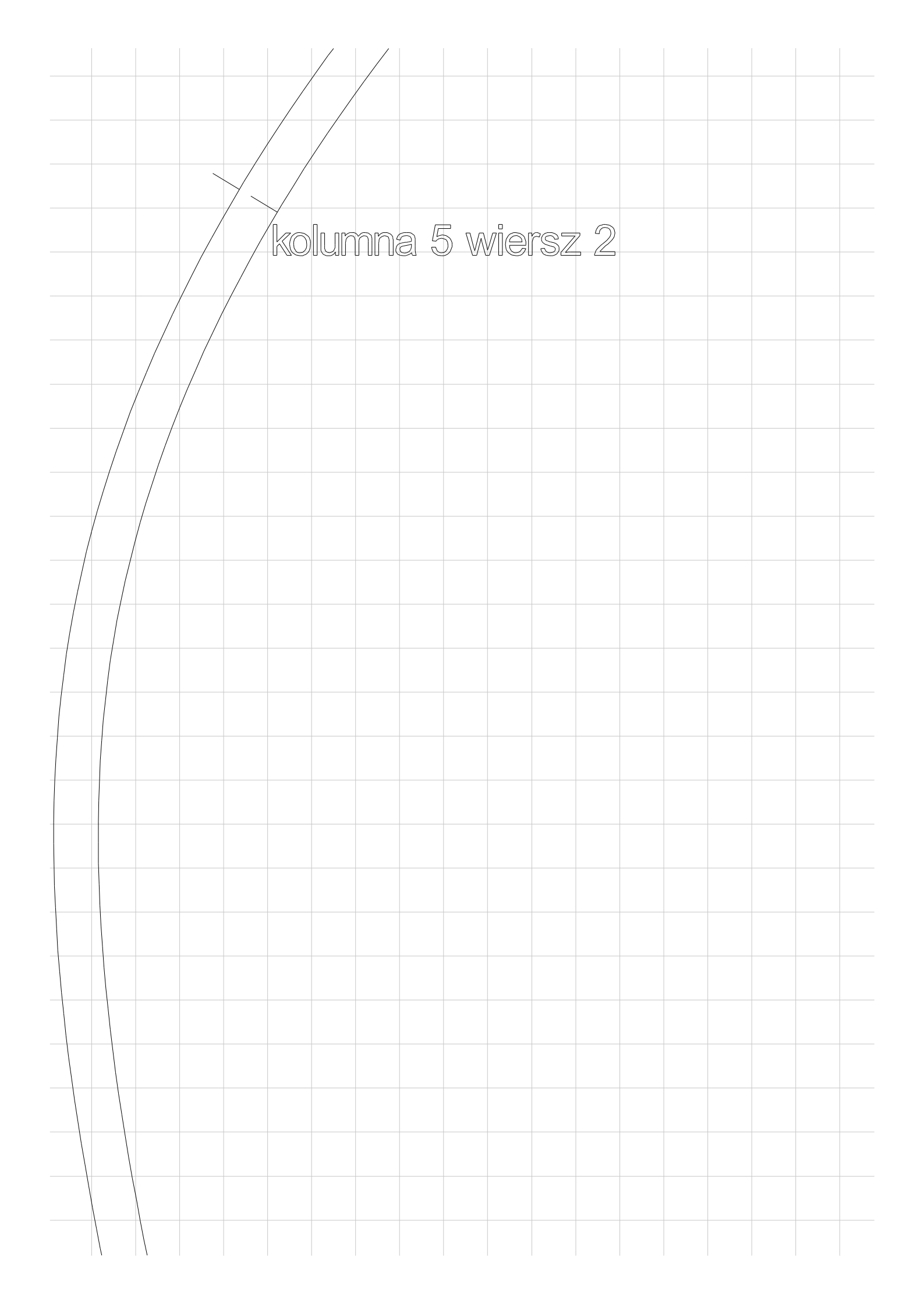

kolumna 5 wiersz 2

kolumna 5 wiersz 3

kolumna 5 wiersz 4

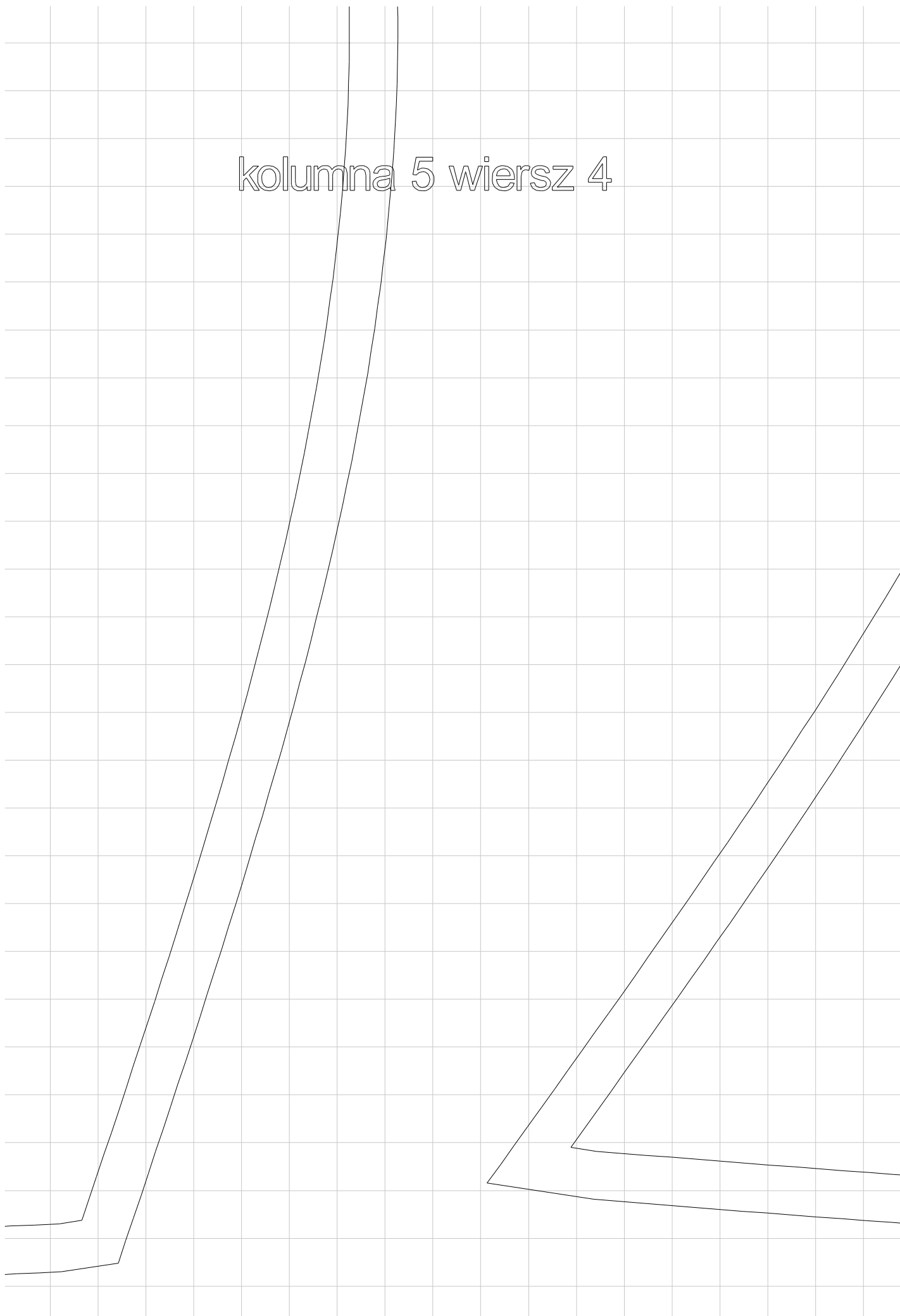

kolumna 6 wiersz 1

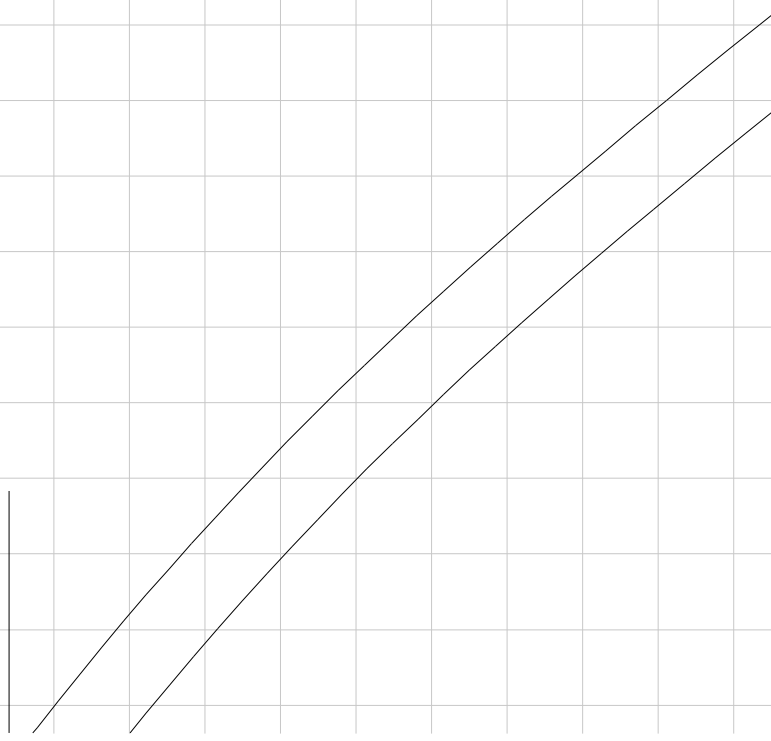
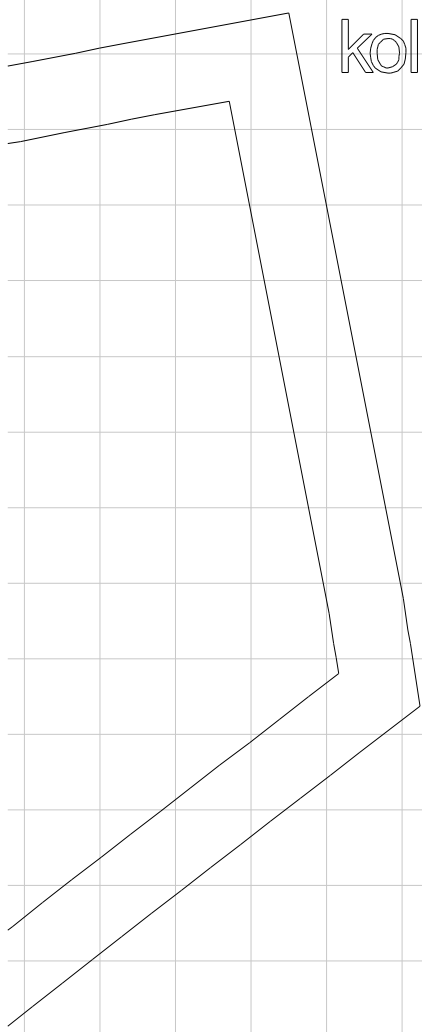

kolumna 6 wiersz 2

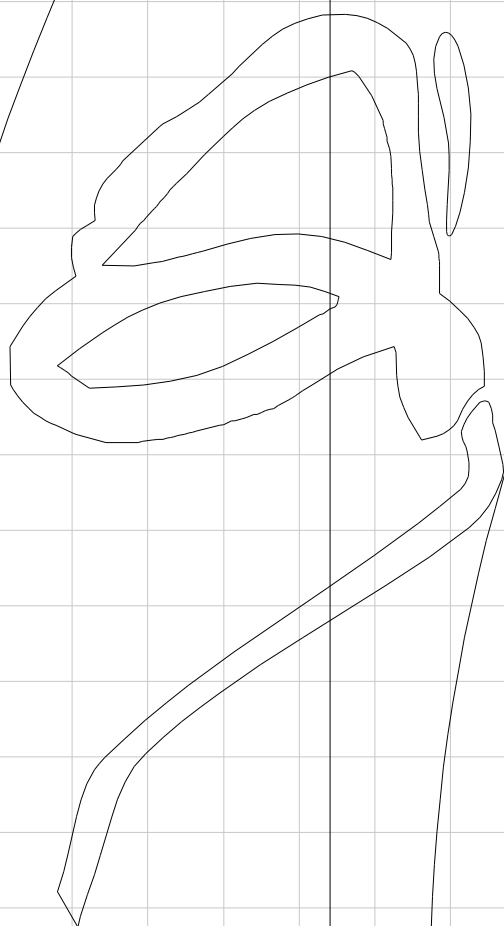

kolumna 6 wiersz 3

straight grain

nitka prosta

kolumna 6 wiersz 4

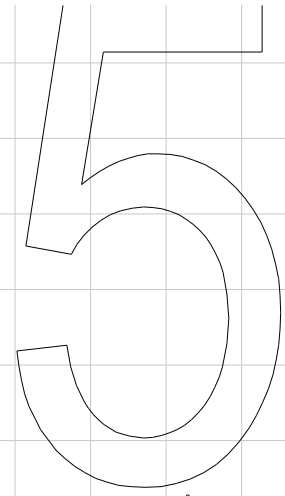

przód / front

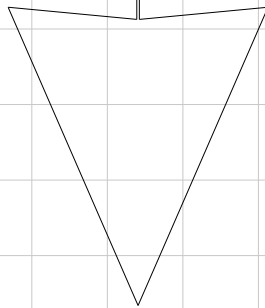

kolumna 7 wiersz 1



tyt / back

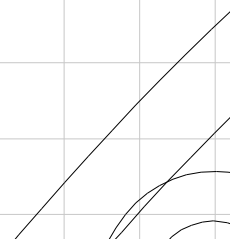
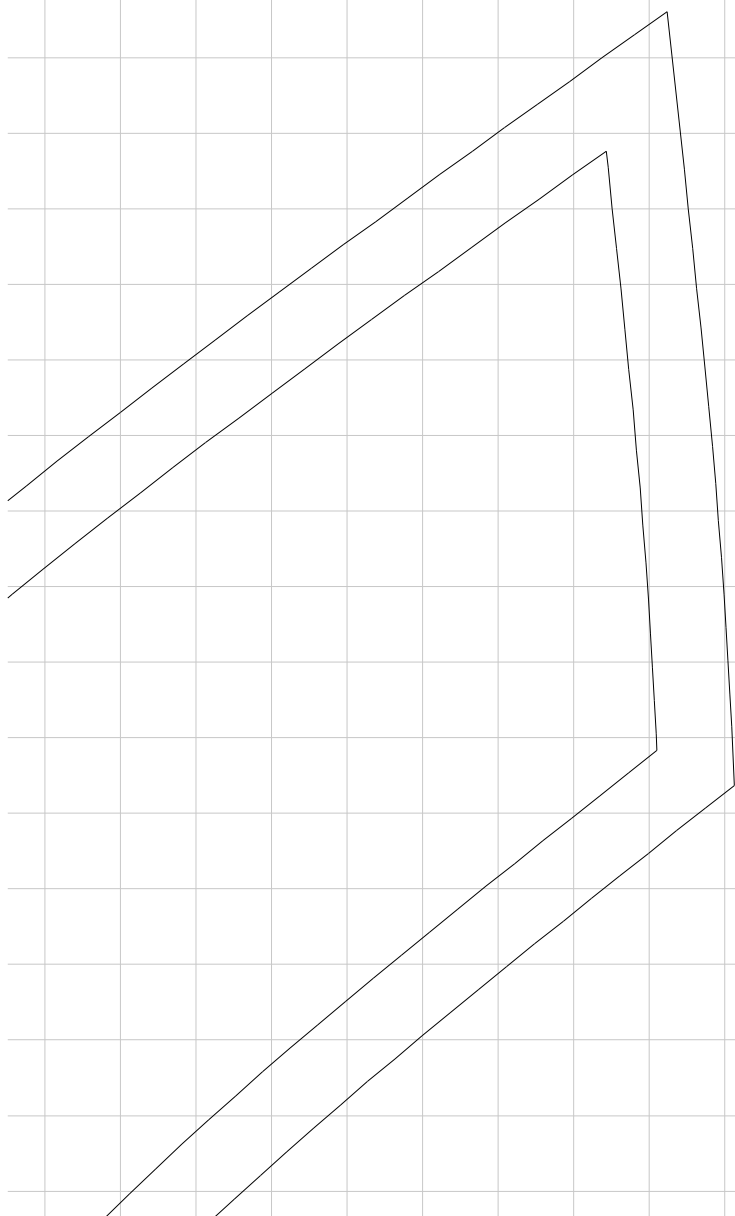

kolumna 7 wiersz 2

ptz6c

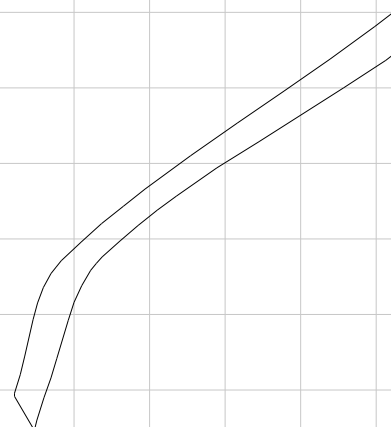
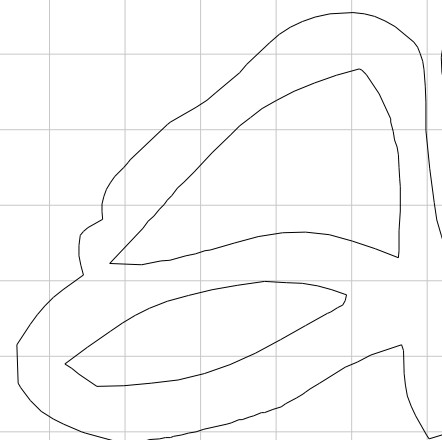

kolumna 7 wiersz 3

straight grain

kolumna 7 wiersz 4

ł

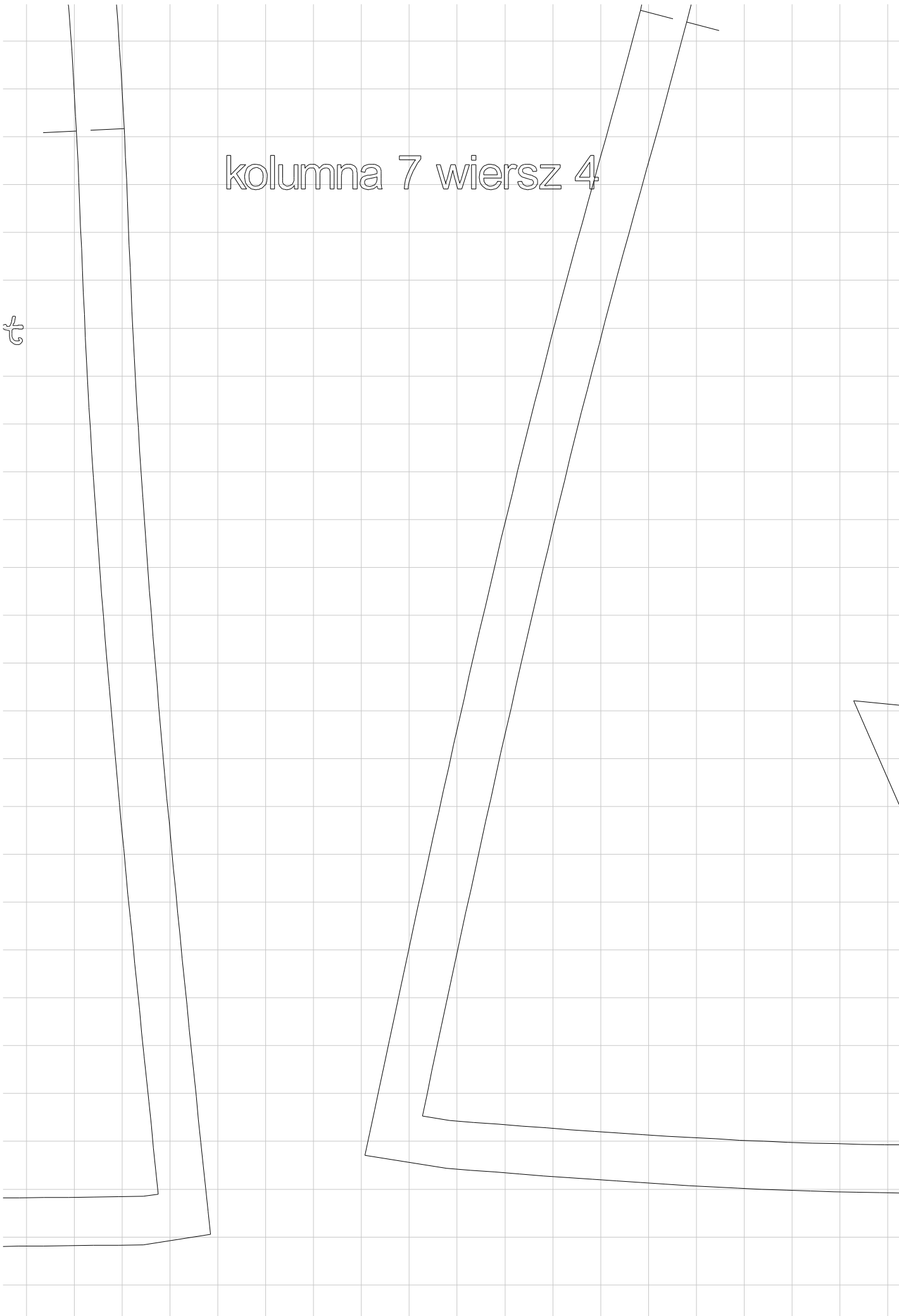

kolumna 8 wiersz 1

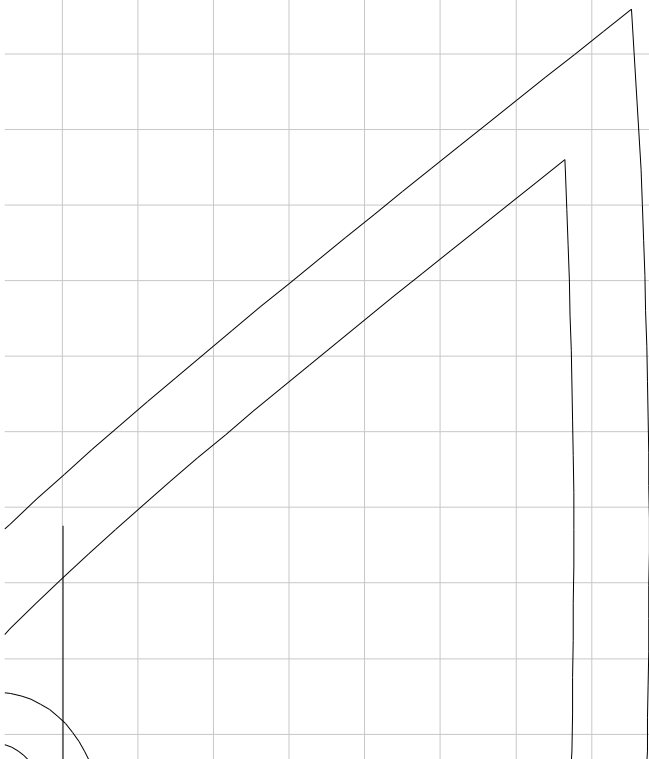

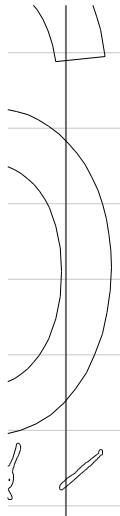

front

kolumna 8 wiersz 2

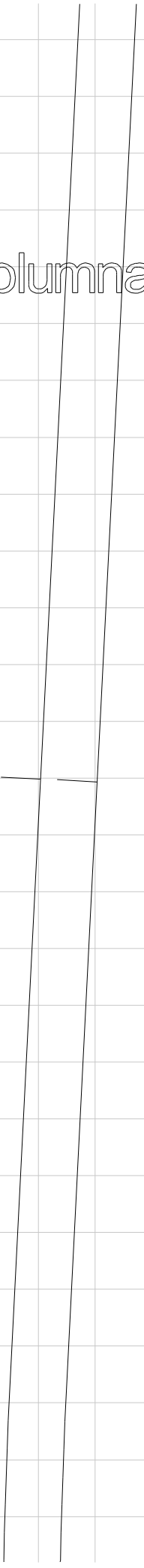

kolumna 8 wiersz 3

nitka prosta

WVWV-V

didžioji
svėčia

kolumna 8 wiersz 4

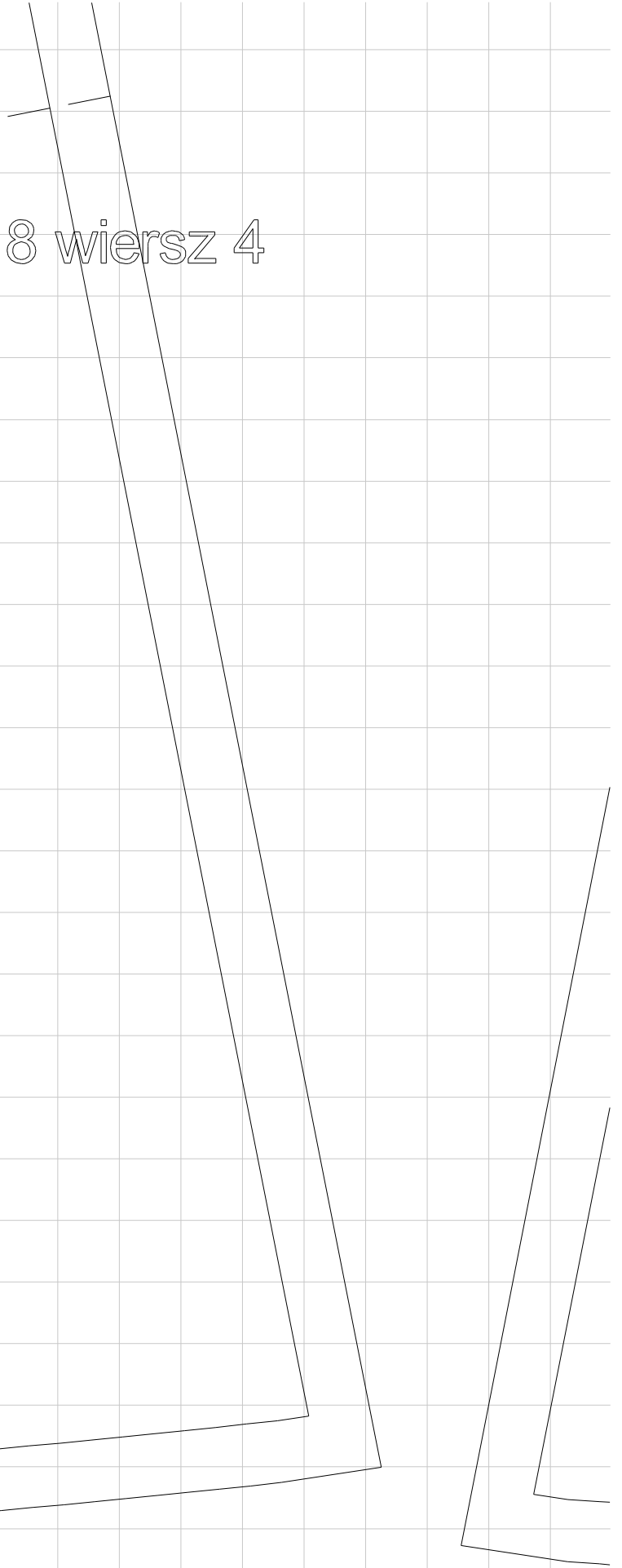
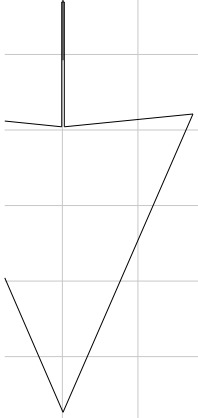

kolumna 9 wiersz 1

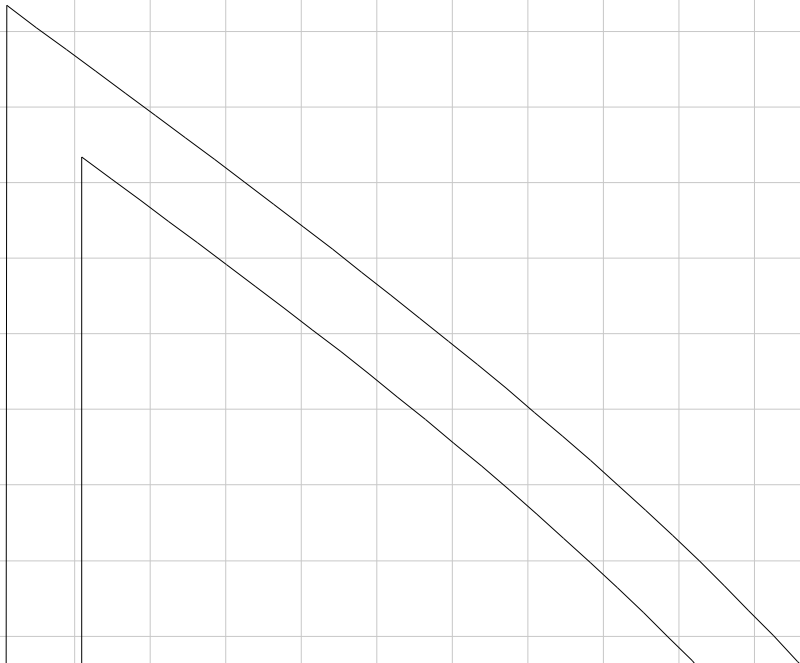

kolumna 9 wiersz 2

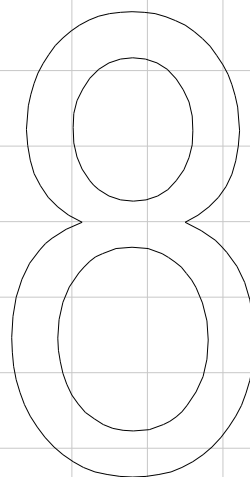

tył / back

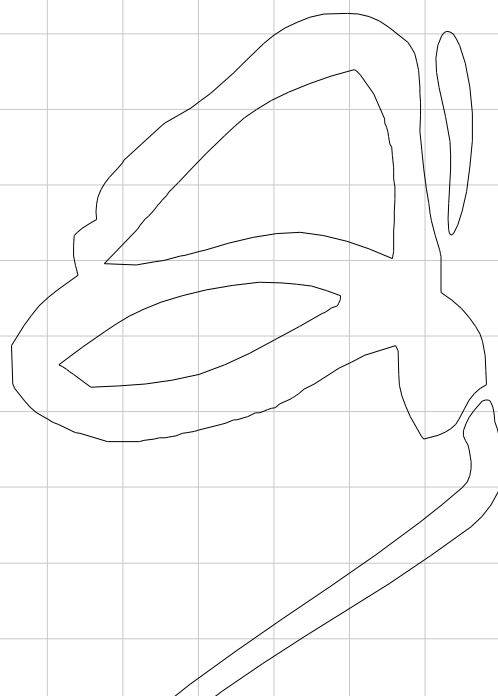

kolumna 9 wiersz 3

straight grain

nitka prosta

WVWVWV

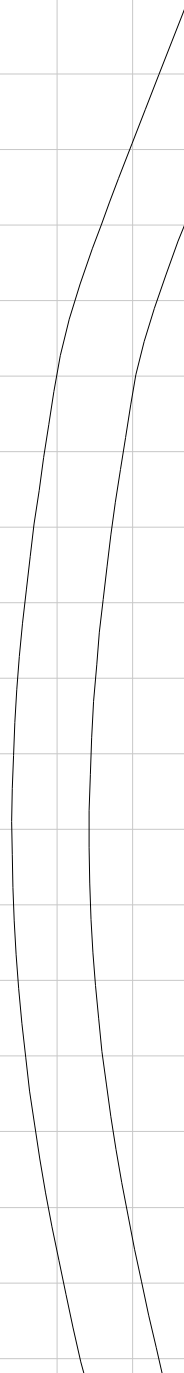
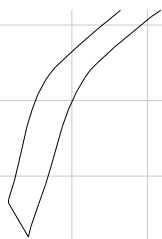

kolumna 9 wiersz 4

di.Overland

kolumna 10 wiersz 1

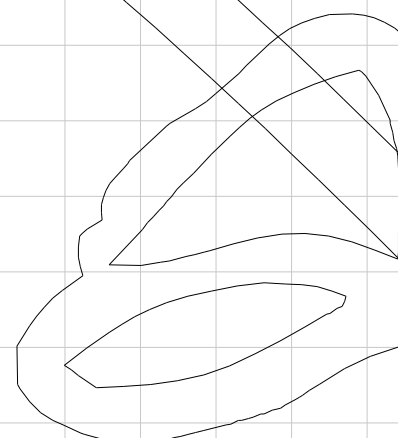

kolumna 10 wiersz 2

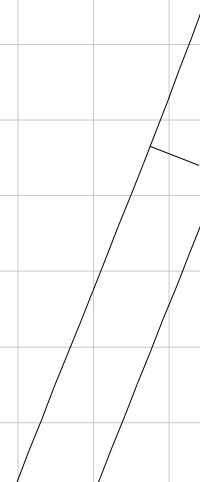
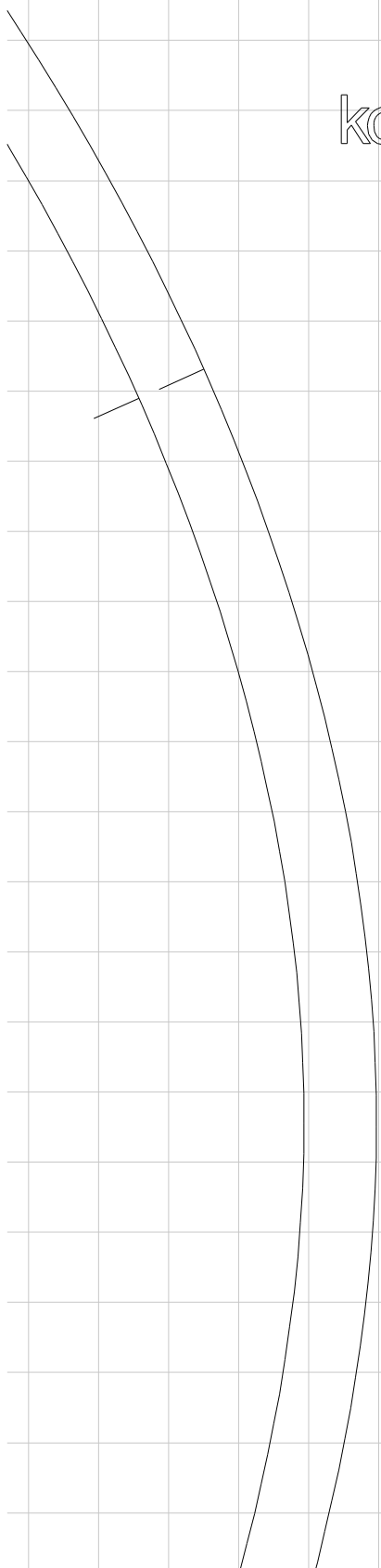

kolumna 10 wiersz 3

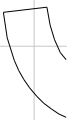

tg

kolumna 10 wiersz 4

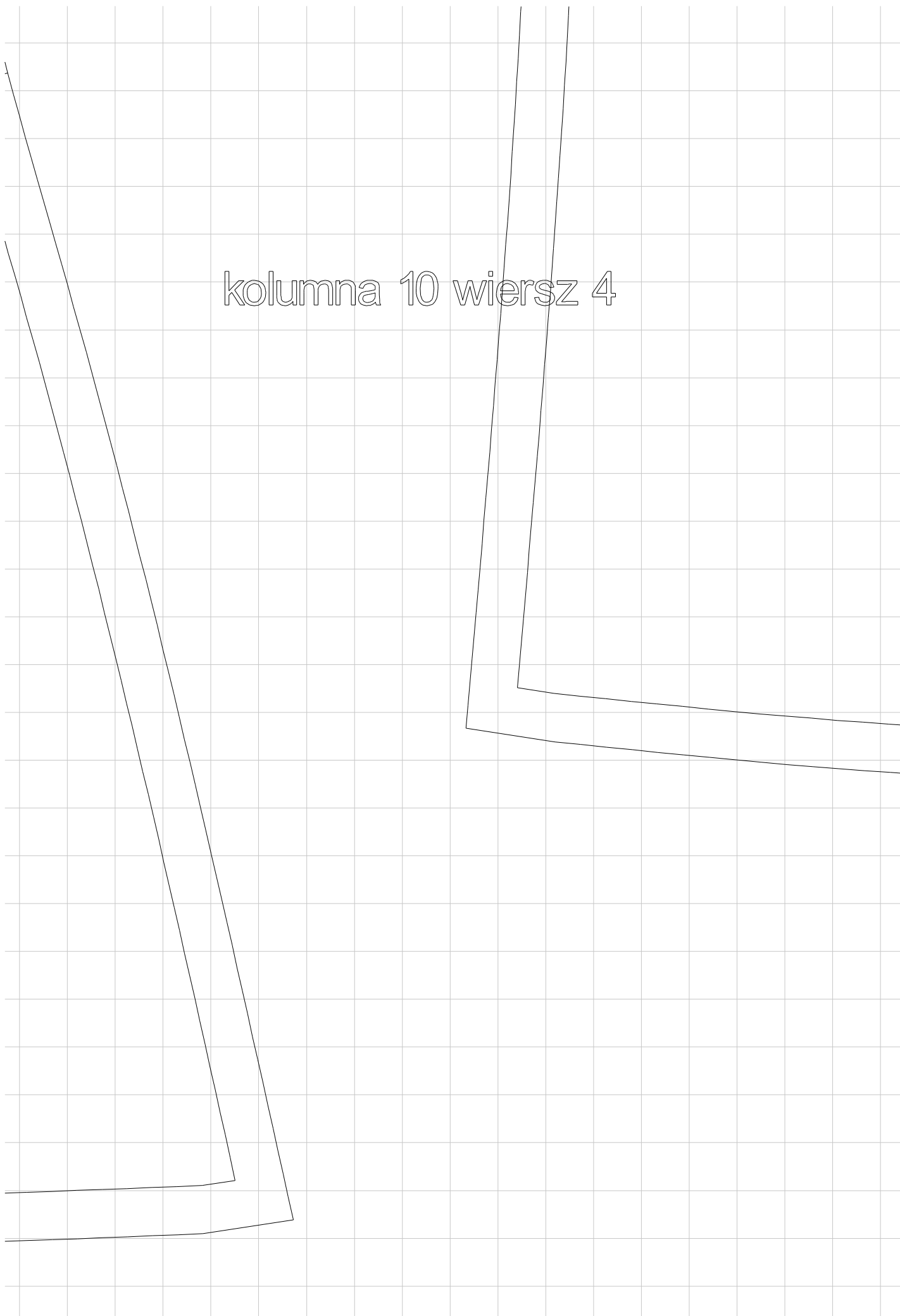

kolumna 11 wiersz 1

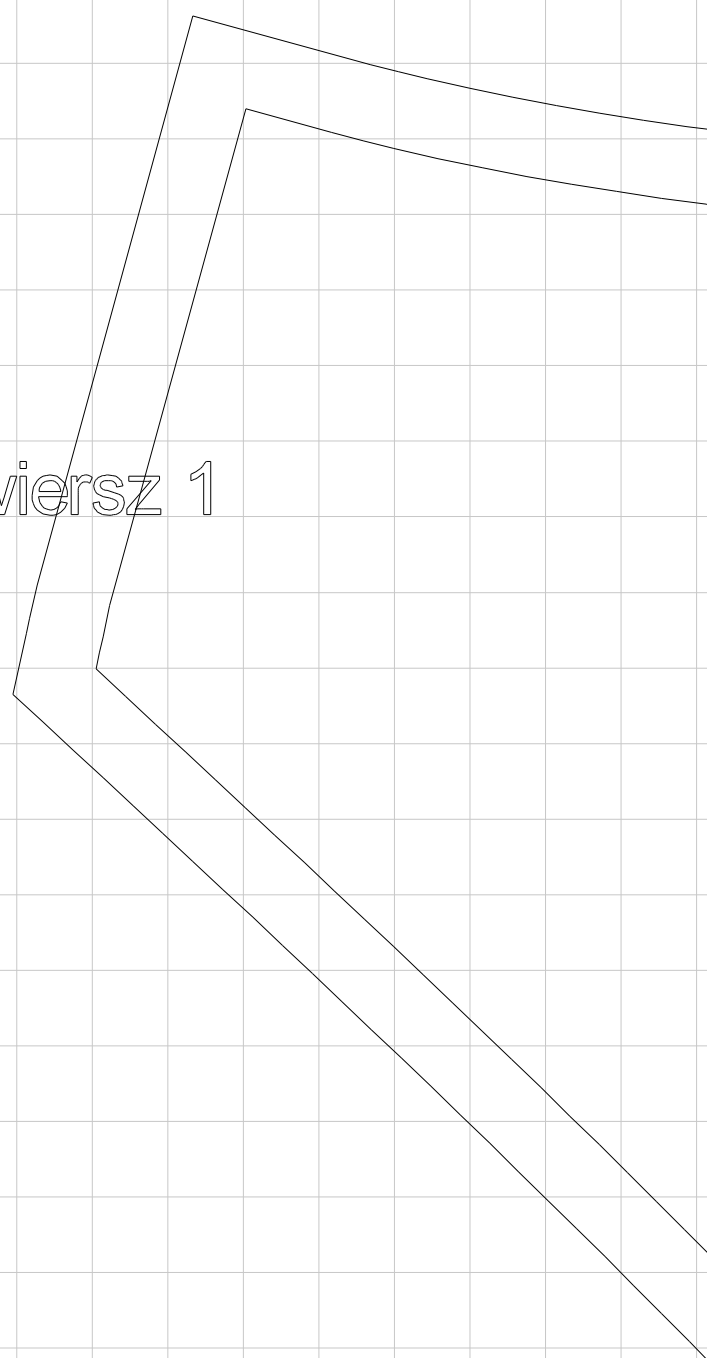



kolumna 11 wiersz 2

5. 11 / back

e d e d . W W W W W W W W W W

kolumna 11 wiersz 3

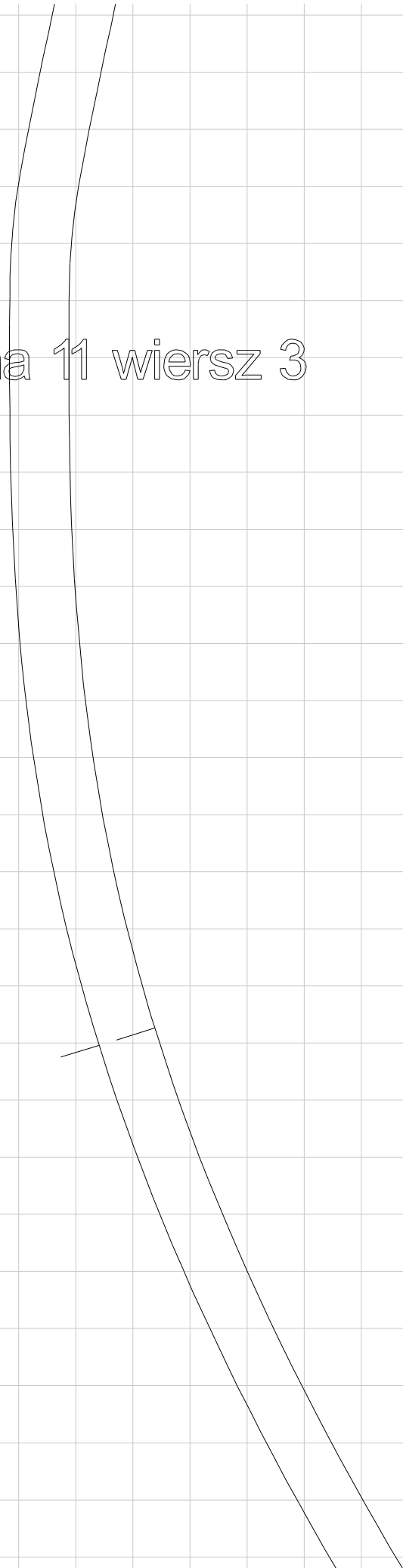

V

E

T

kolumna 11 wiersz 4

O

.

h

l

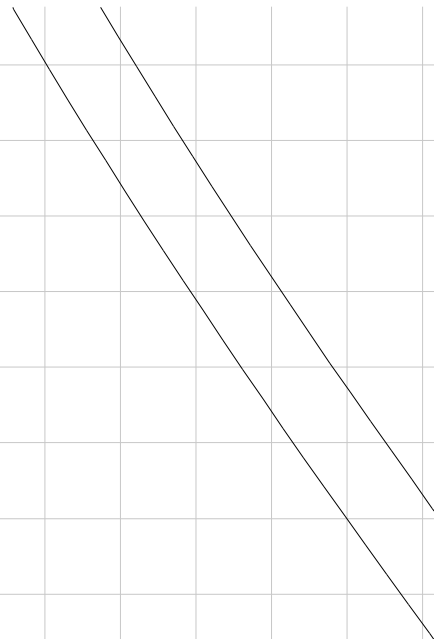

kolumna 12 wiersz 1

10

tyt / back

2

3

kolumna 12 wiersz 2

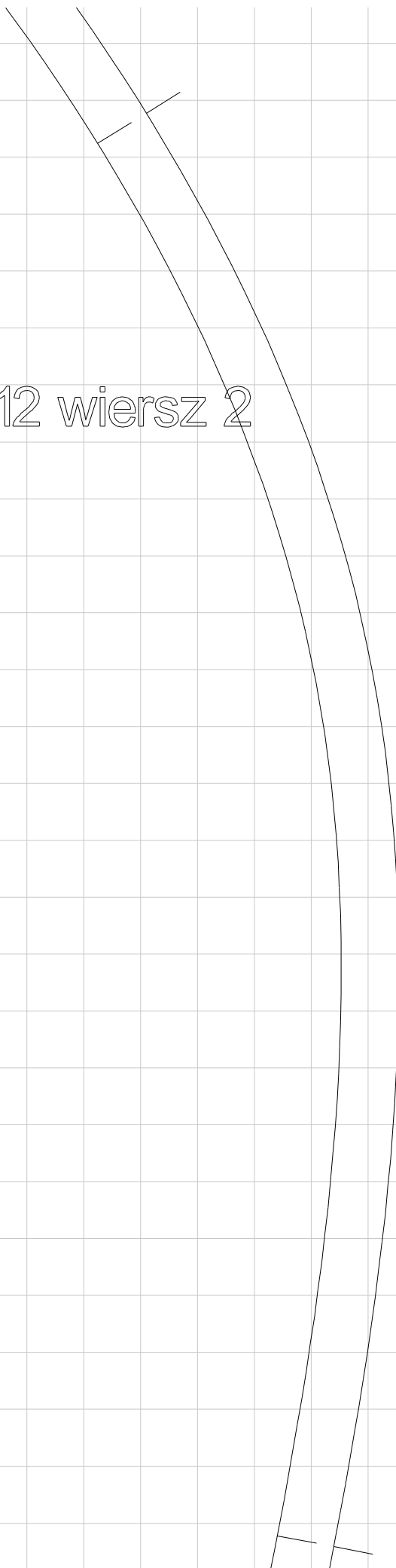

kolumna 12 wiersz 3

© p e d . W W W . p e d .

kolumna 12 wiersz 4

WERTOPI

kolumna 13 wiersz 1

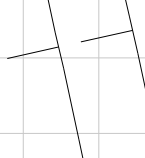

joint grain

nitka p

kolumna 13 wiersz 2

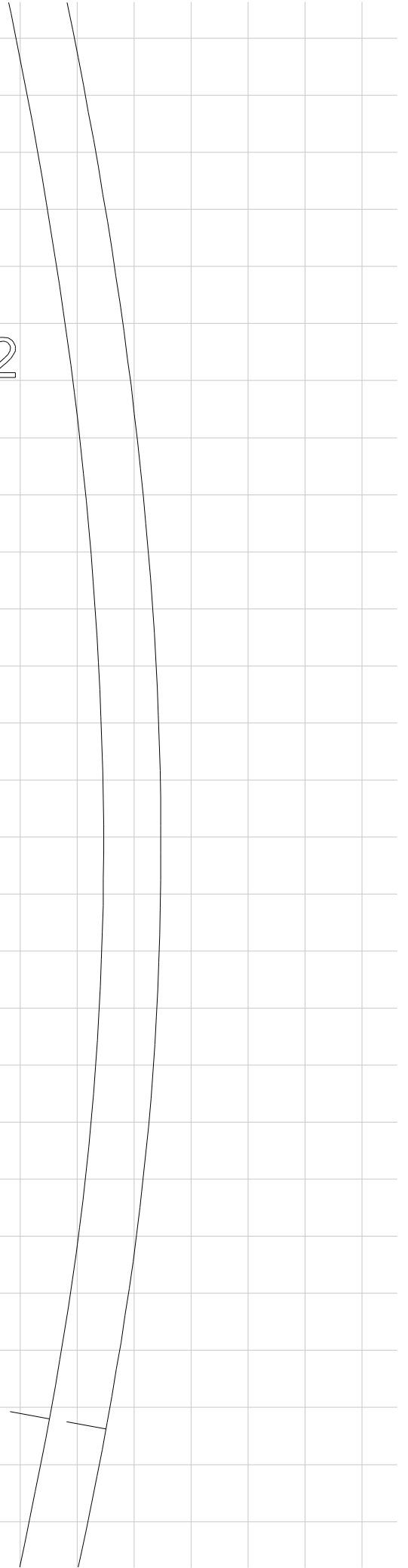

strajc

rosta

kolumna 13 wiersz 3

— —

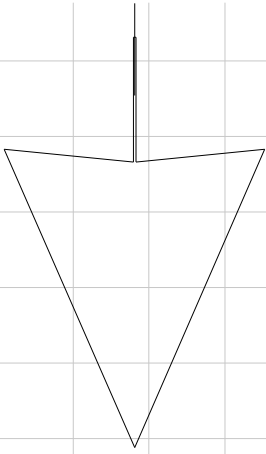

kolumna 13 wiersz 4

]



kolumna 14 wiersz 1

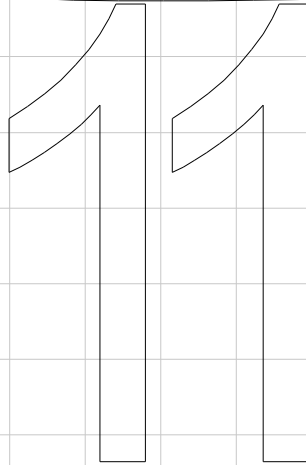

tył / back

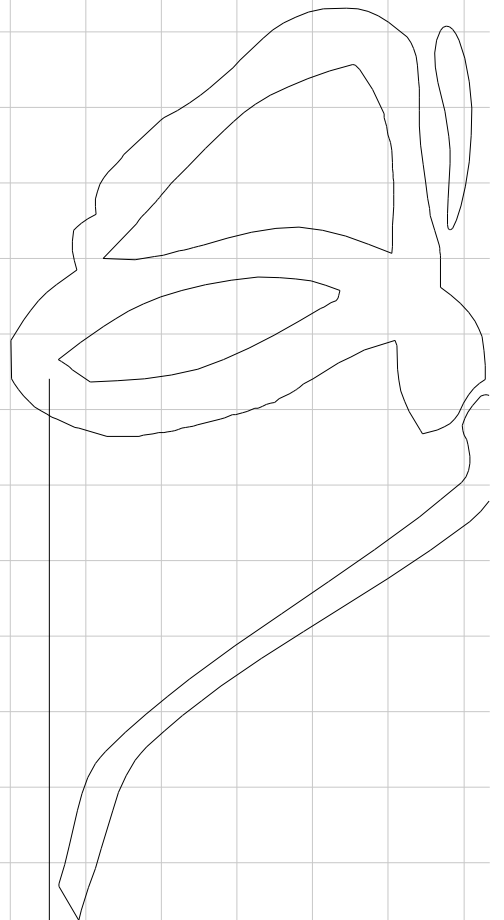

kolumna 14 wiersz 2

kolumna 14 wiersz 3

straight grain

nitka prosta

W.W.W.V.P

kolumna 14 wiersz 4

id.ioda

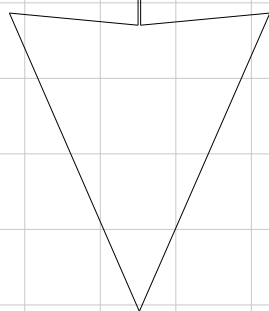

kolumna 15 wiersz 1

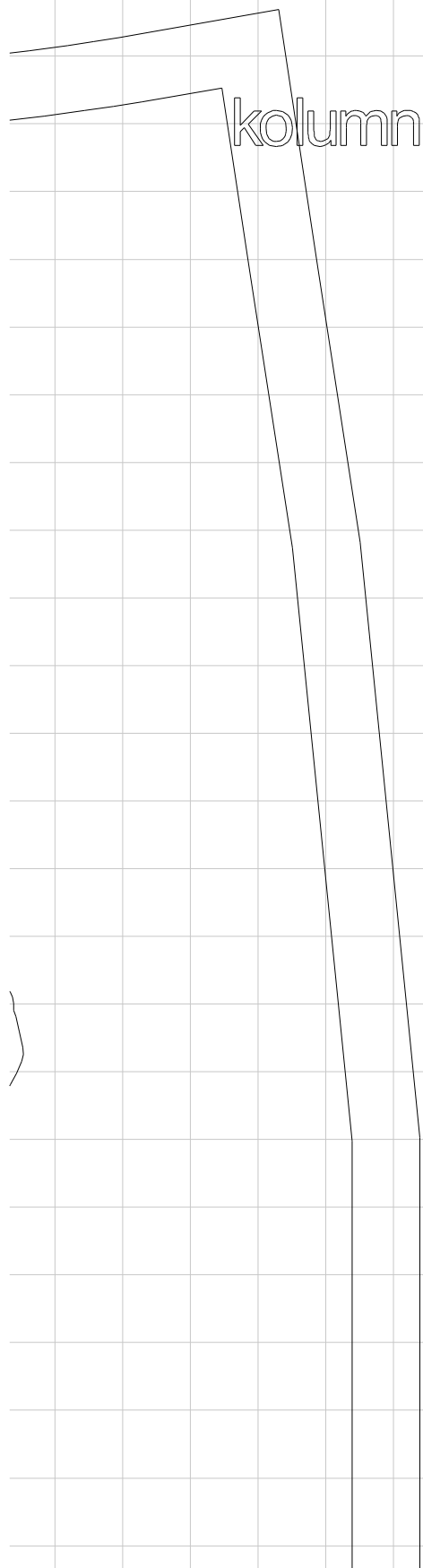

kolumna 15 wiersz 2



kolumna 15 wiersz 3

kolumna 15 wiersz 4

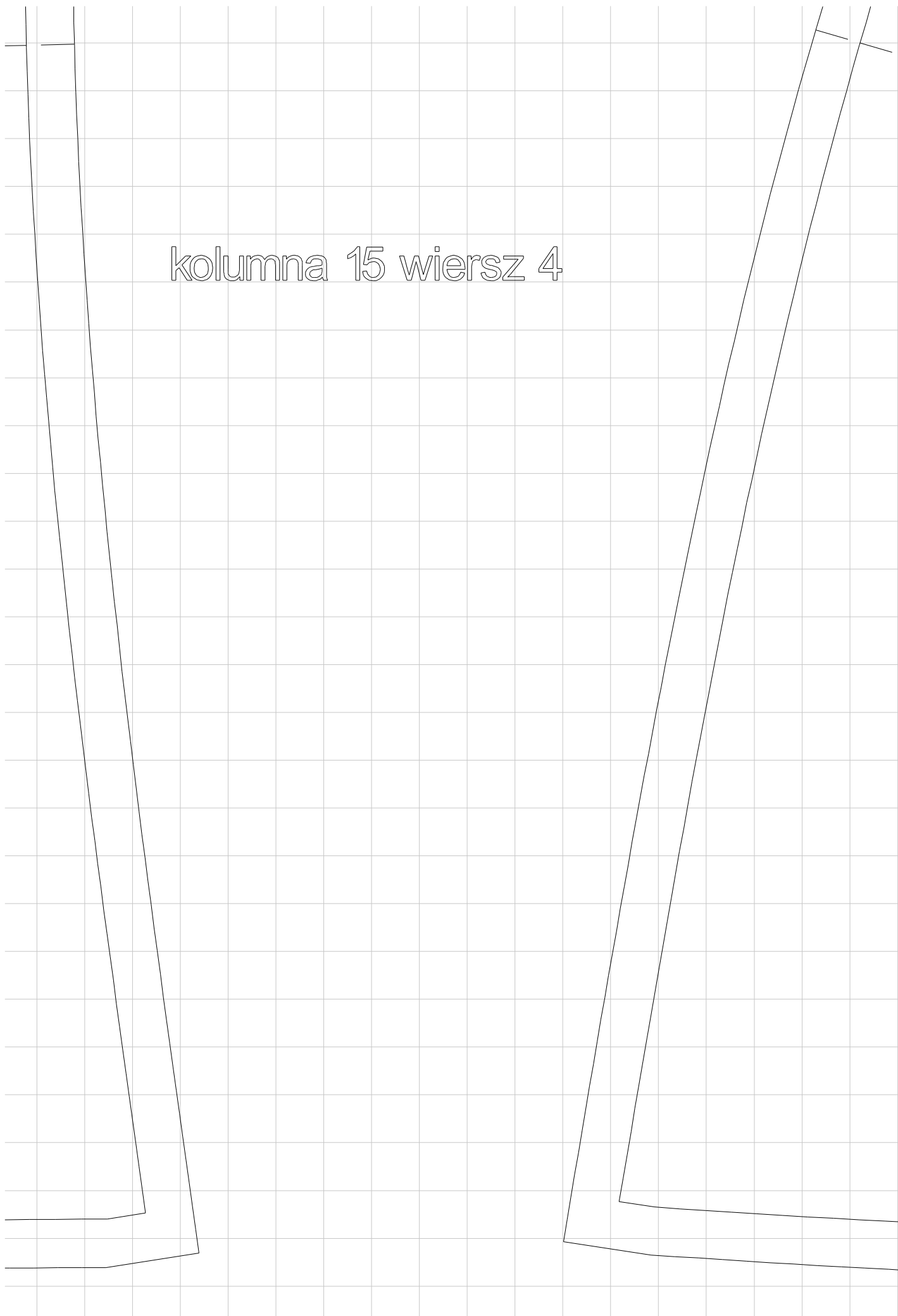

kolumna 16 wiersz 3

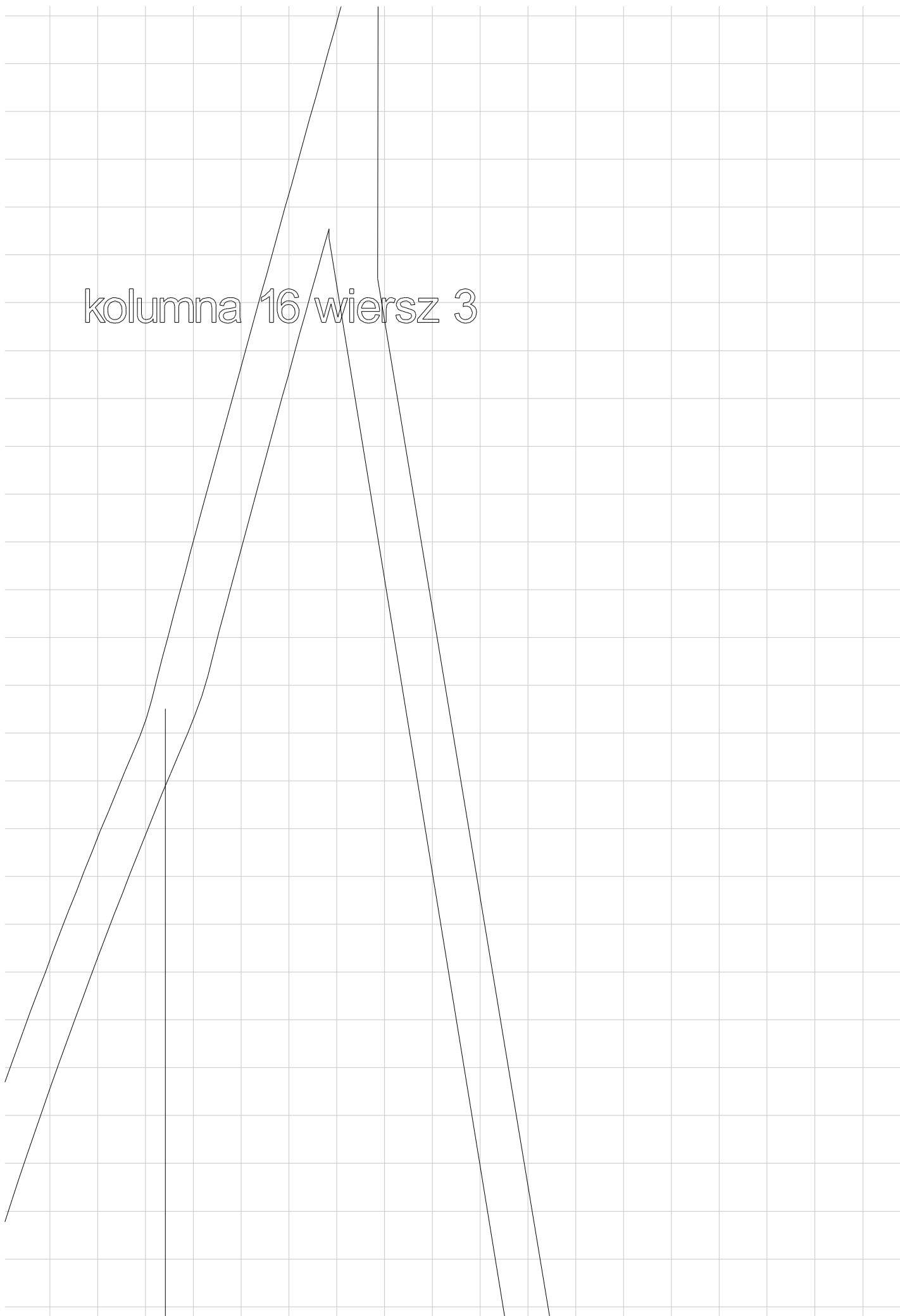

koloryt
straight grain
nitro
prosta
bajso
na 16 wiersz 4

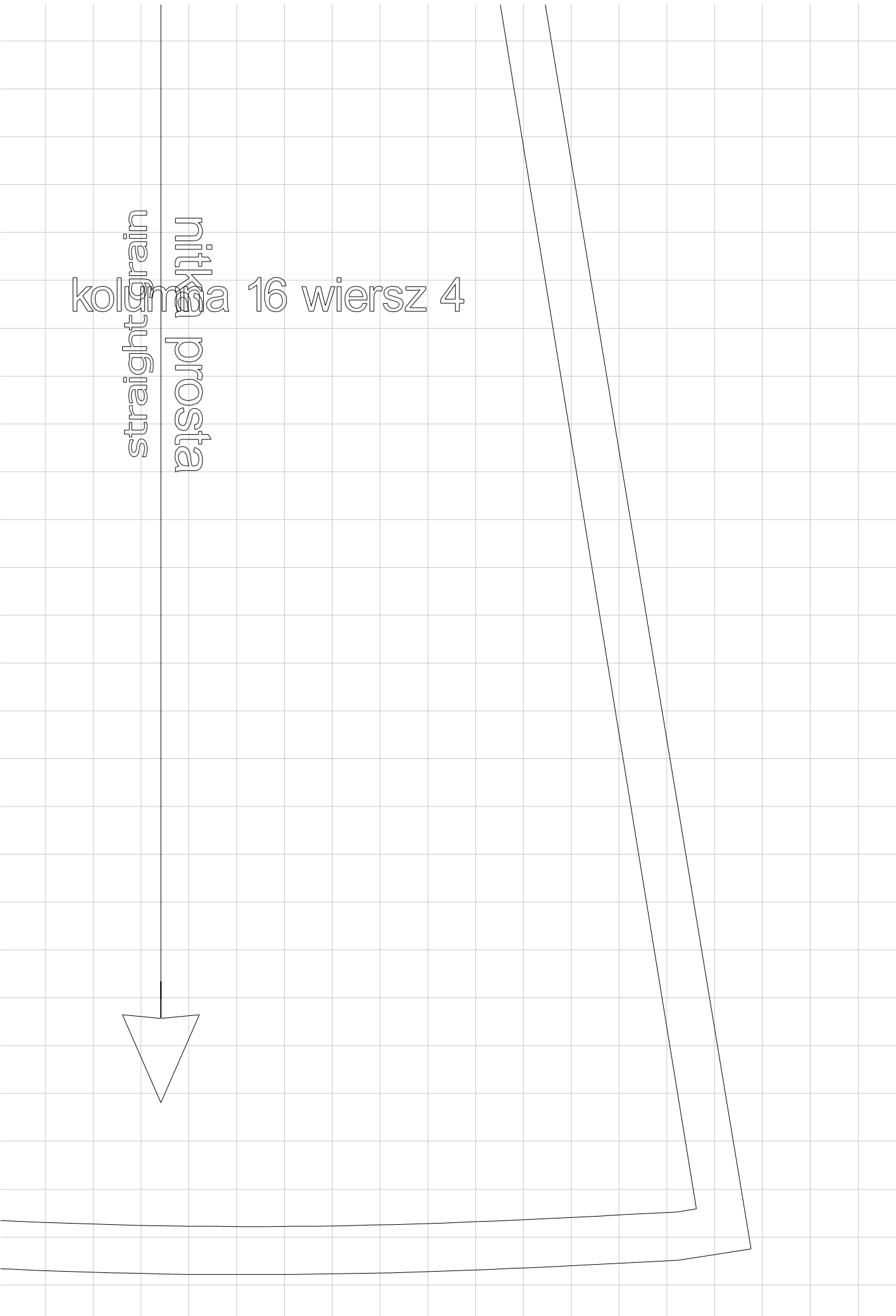
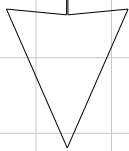

ROZMIAR: 410

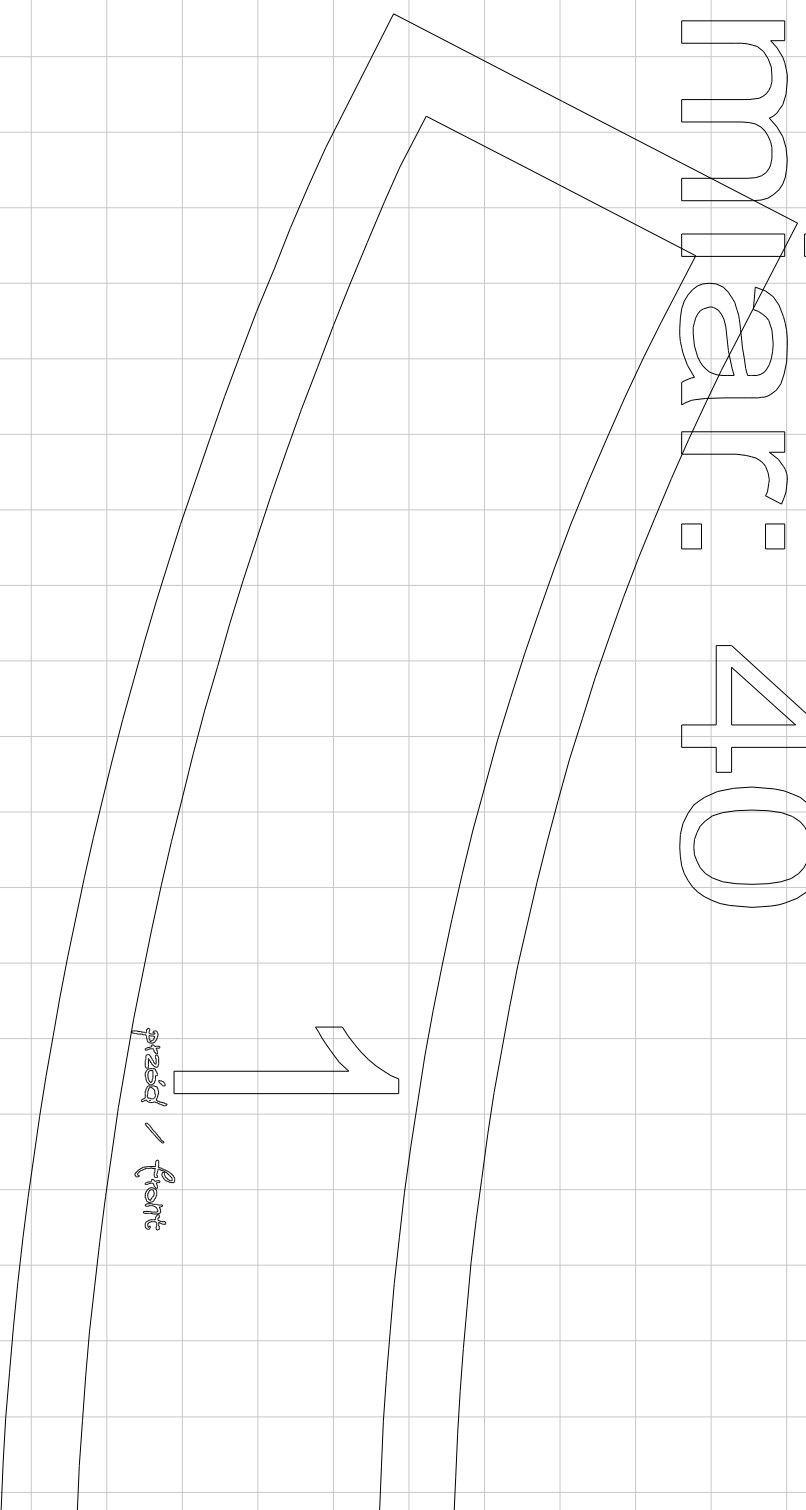

kolumna 1 wiersz 1

5x5 cm

test

wysca 1232

wzrost/height 168 cm

kolumna 1 wiersz 2

kolumna 1 wiersz 3

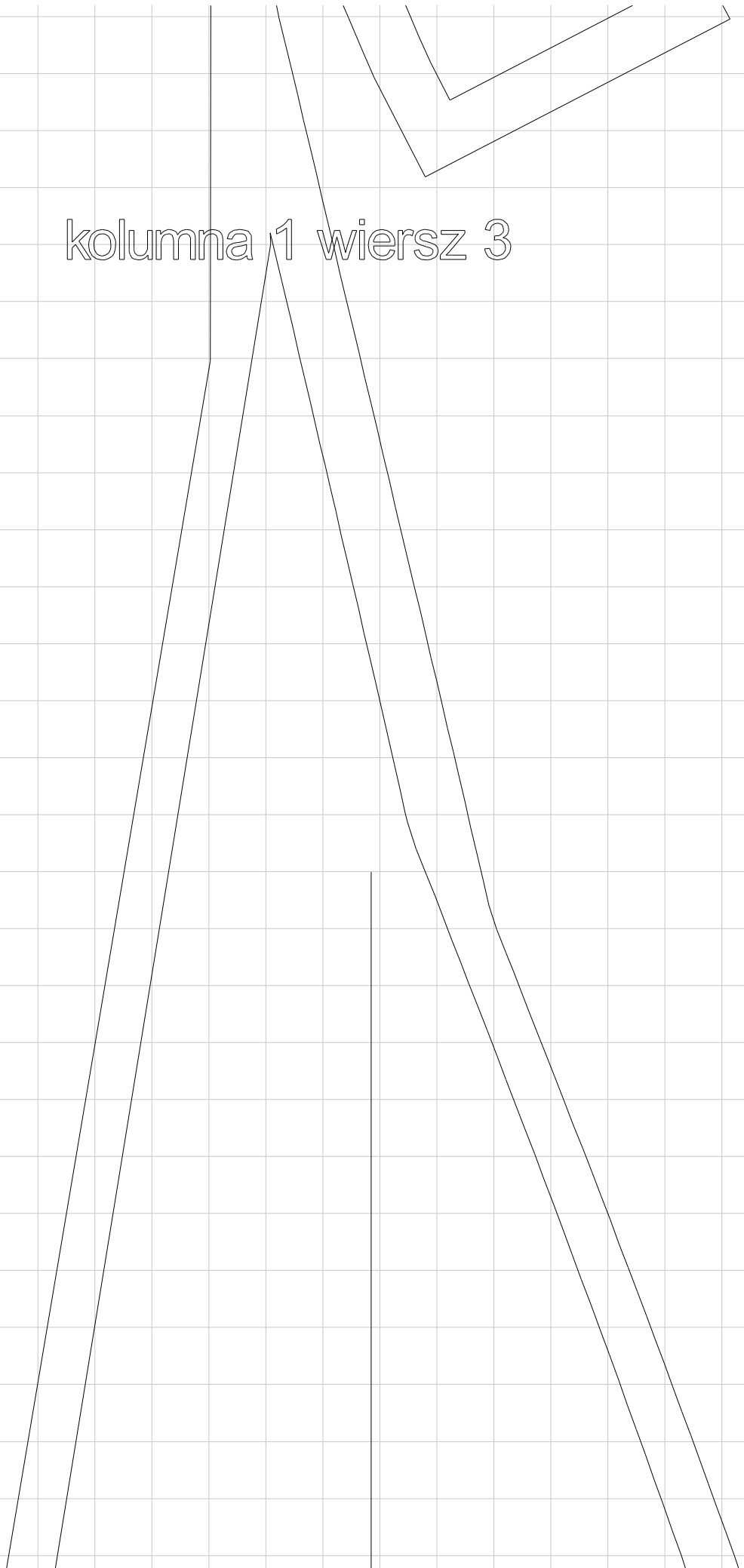

kolumna 1 wiersz 4

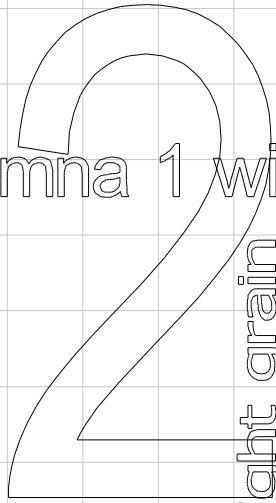

przód

straight grain

nitka prosta
przód

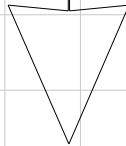

kolumna 2 wiersz 1

3
przód /

5

6

kolumna 2 wiersz 2

ight grain

strai

kolumna 2 wiersz 3



kolumna 2 wiersz 4

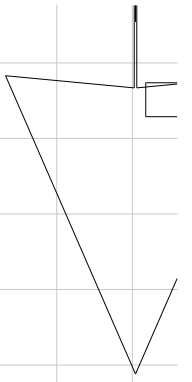
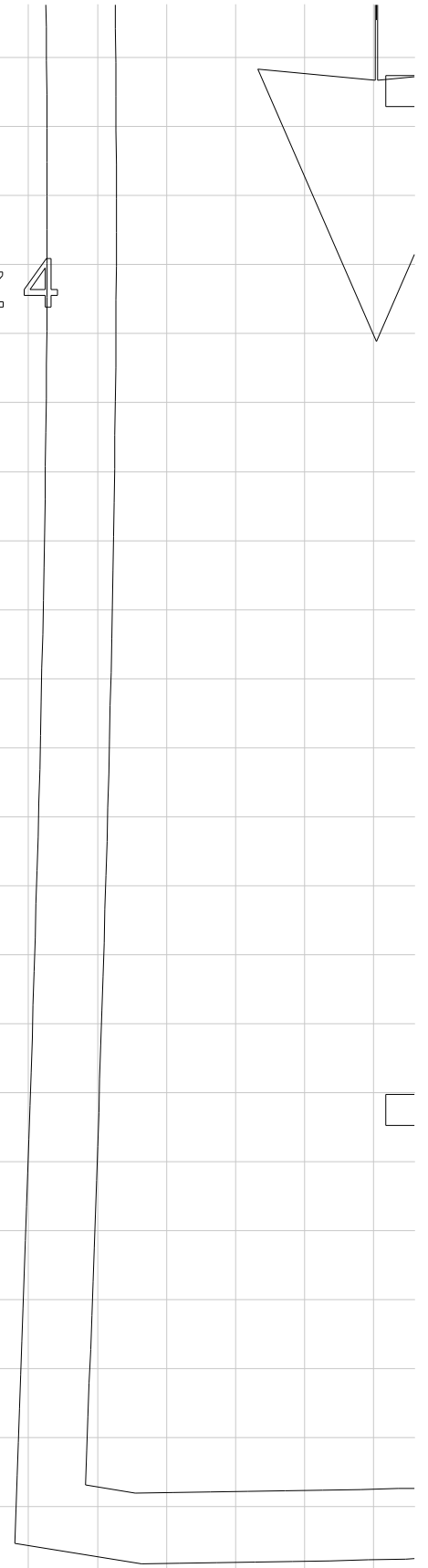
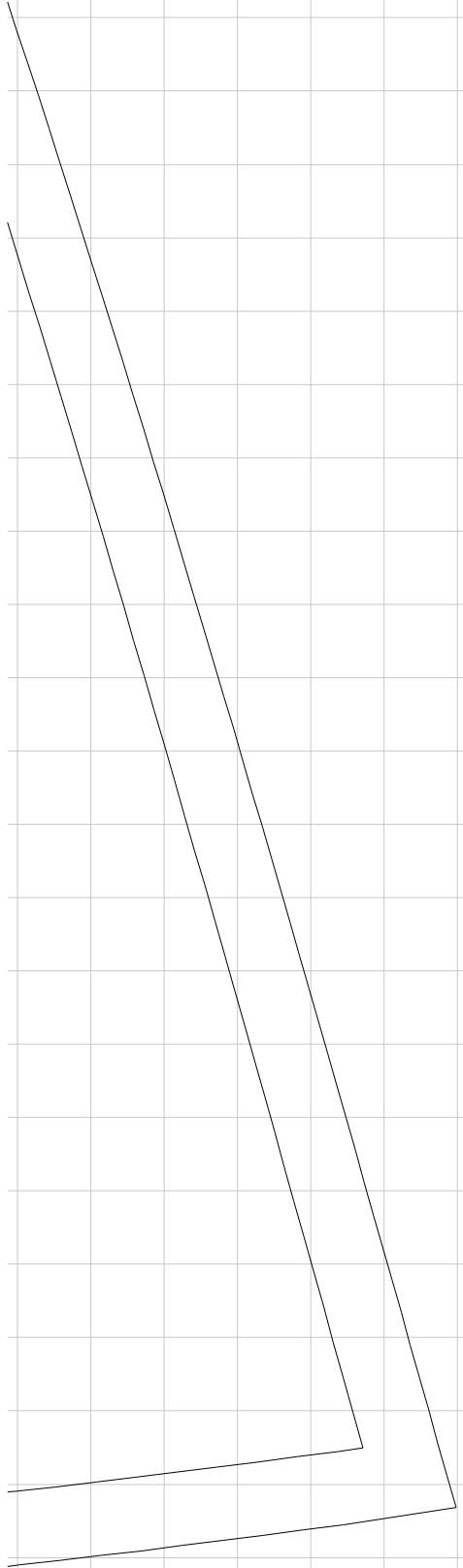

kolumna 3 wiersz 1

)

)

front

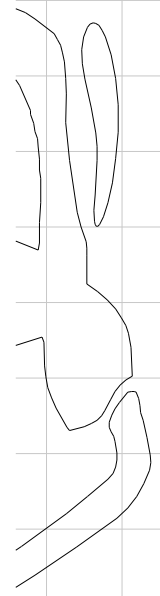

kolumna 3 wiersz 2

nitka por

osta

kolumna 3 wiersz 3

WWW-PC

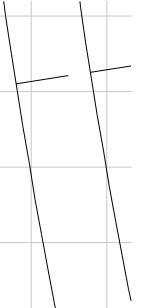

10
2
3
4
5
6
7
8
9
10
11

kolumna 3 wiersz 4

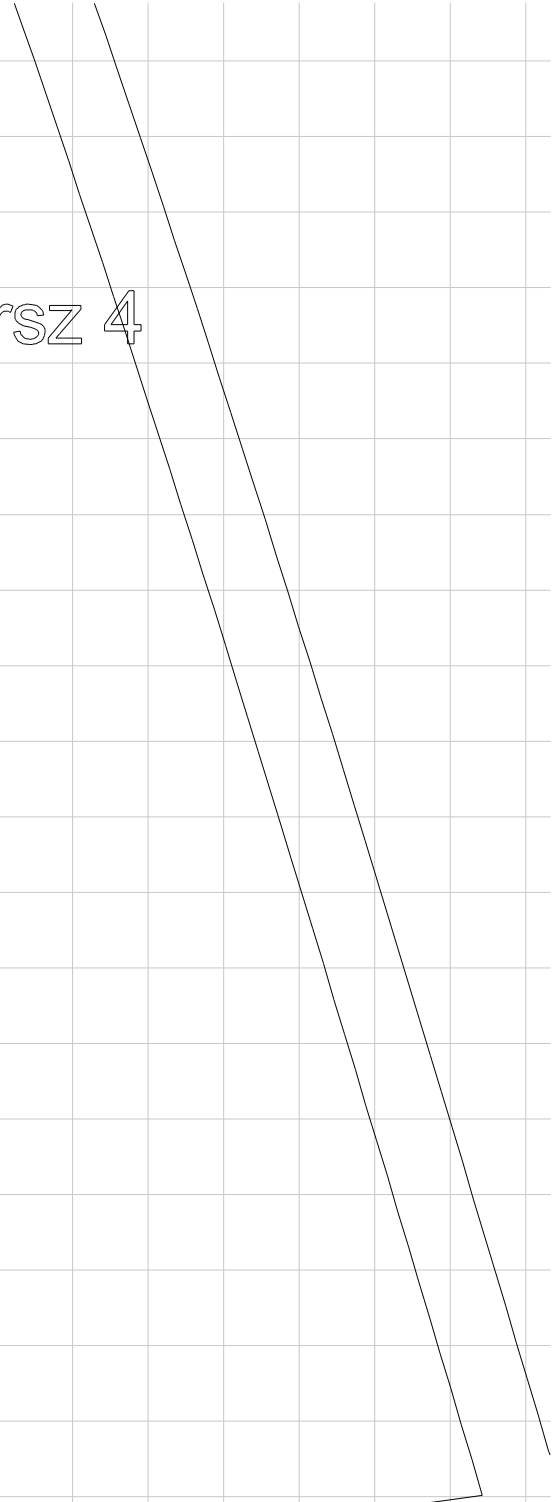

kolumna 4 wiersz 1

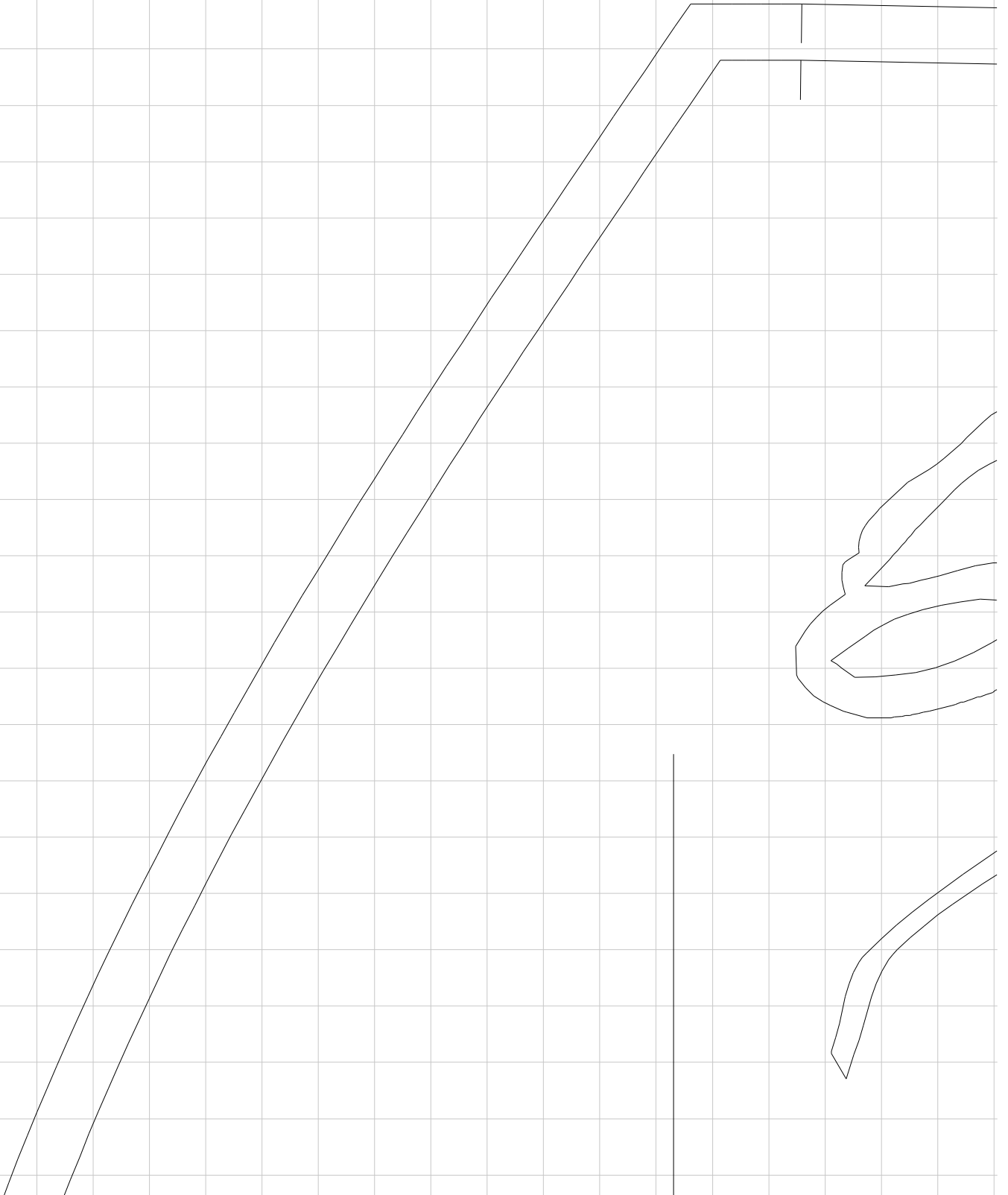

kolumna 4 wiersz 2

edde:www

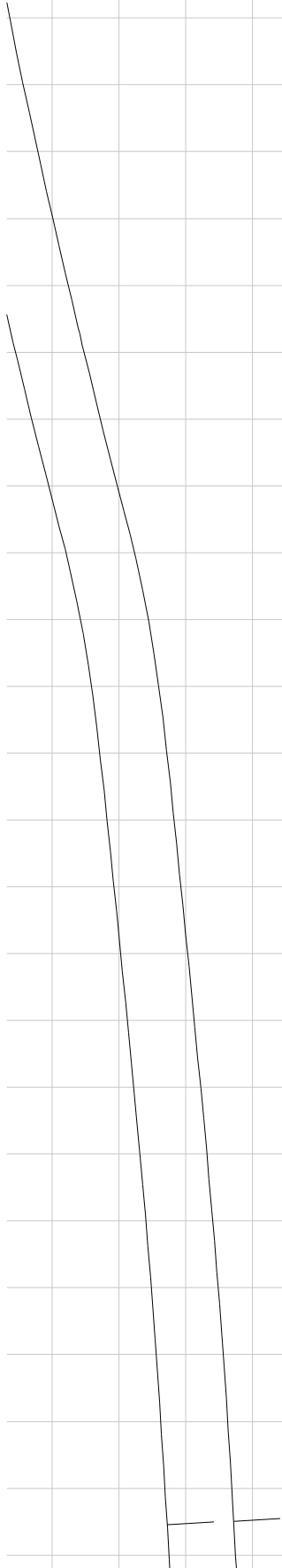

Id. OJEA

kolumna 4 wiersz 3

straight grain

nitke prosty

kolumna 4 wiersz 4

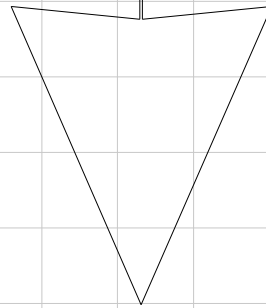

kolumna 5 wiersz 1

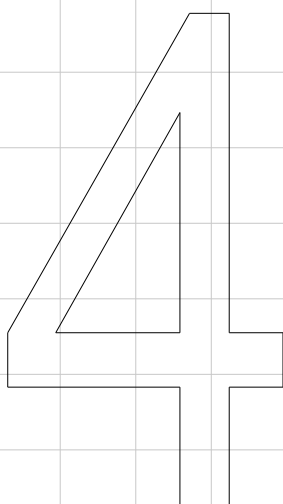

przód / front

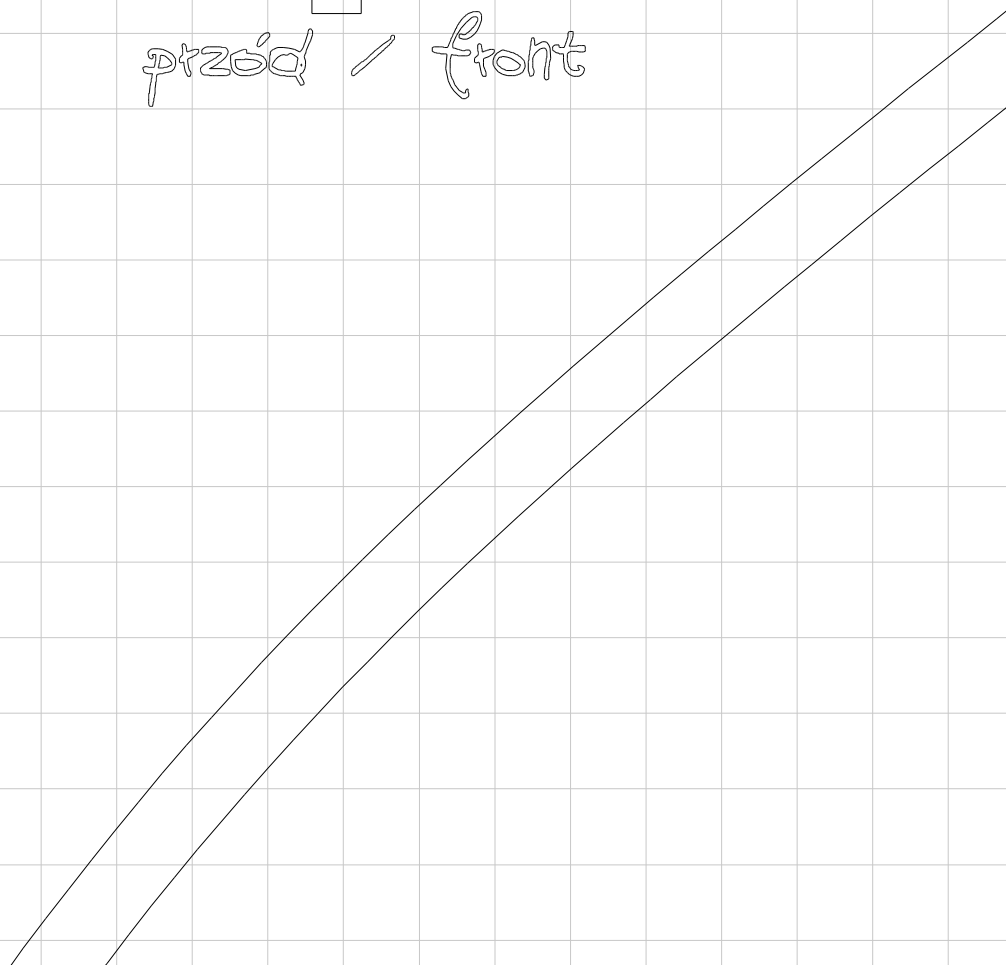
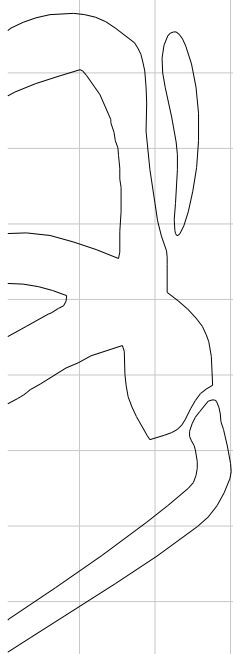



kolumna 5 wiersz 2

kolumna 5 wiersz 3

kolumna 5 wiersz 4

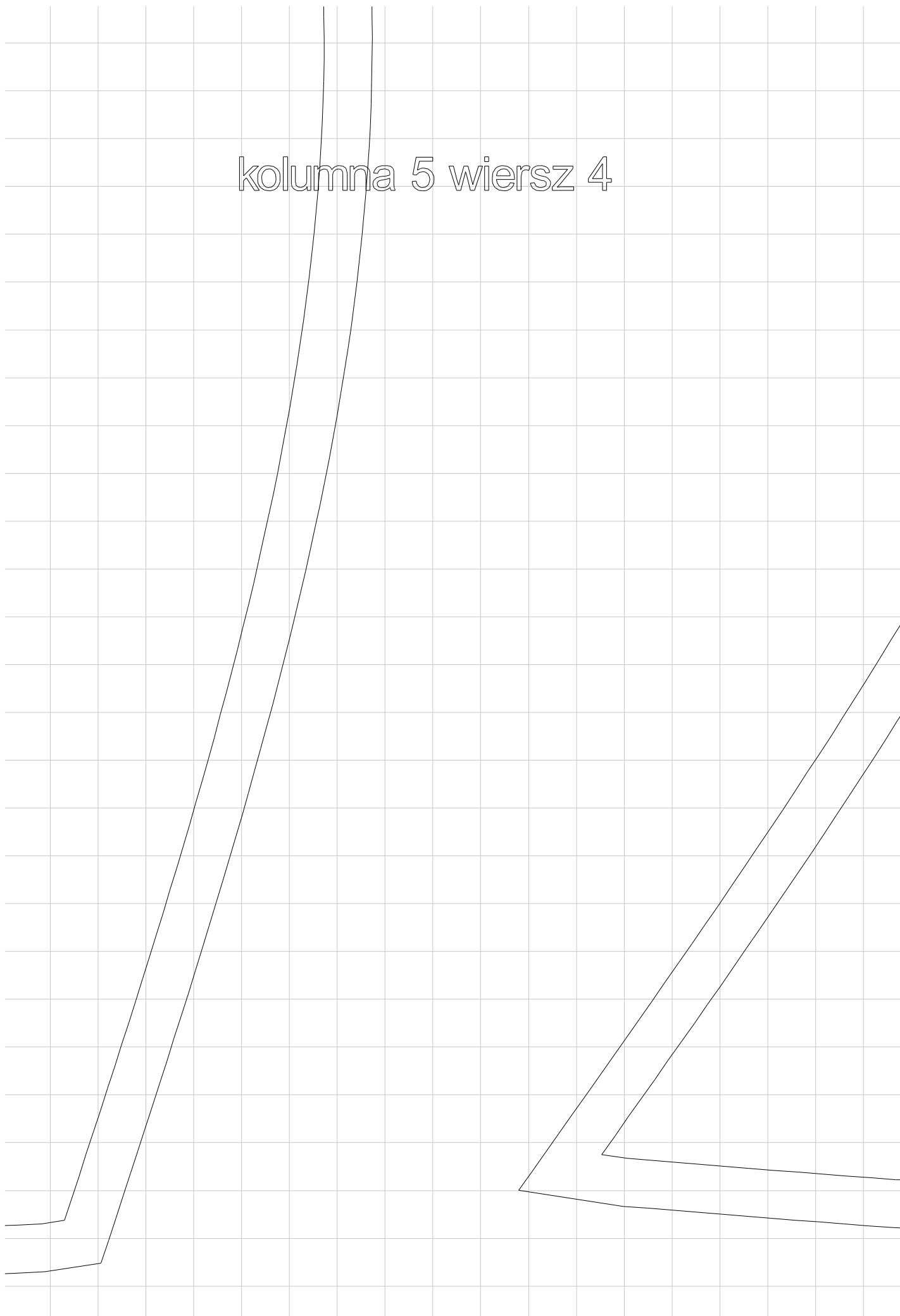

kolumna 6 wiersz 1

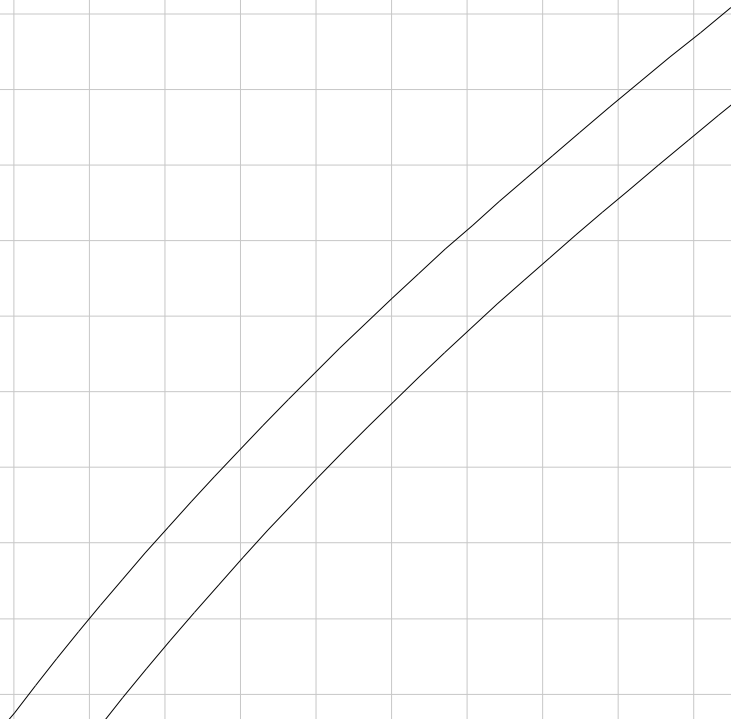
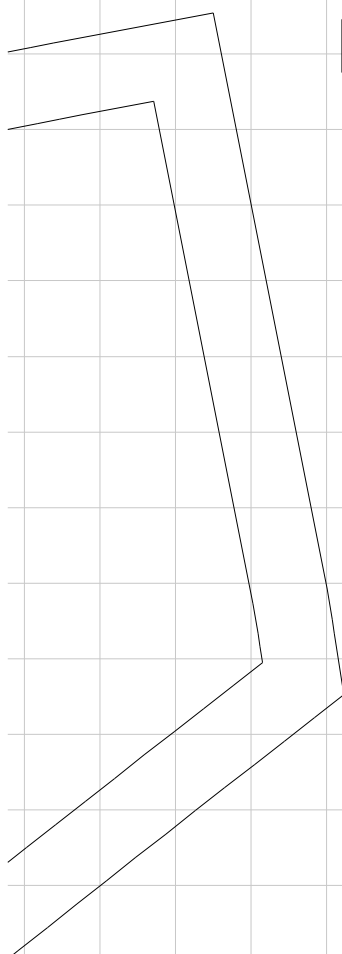

kolumna 6 wiersz 2

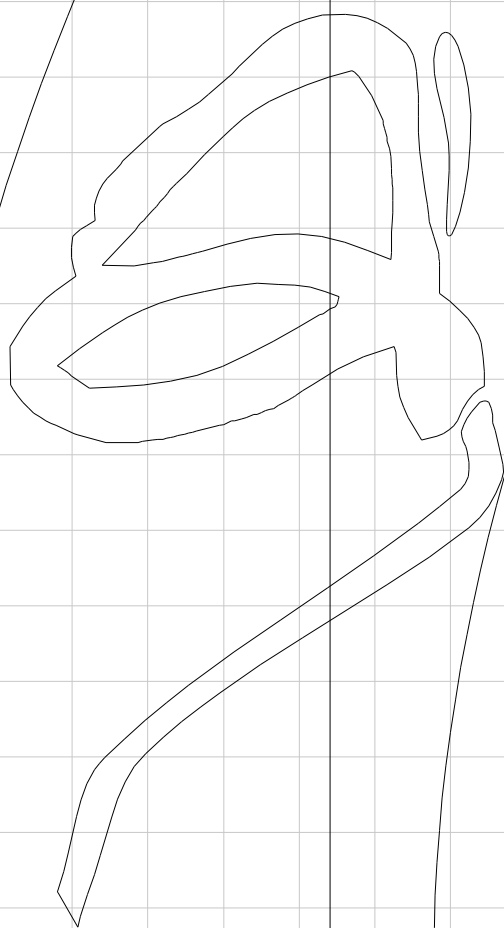

kolumna 6 wiersz 3

straight grain

nitka prosta

kolumna 6 wiersz 4

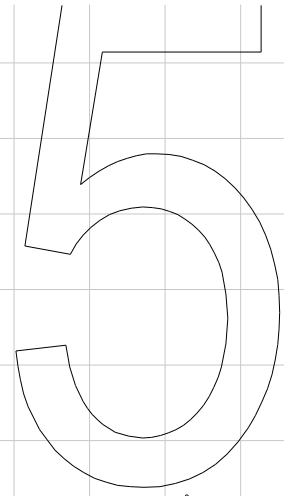

przód / front

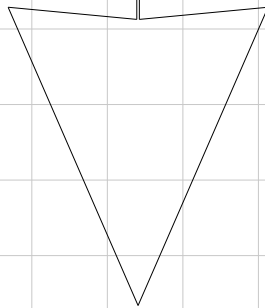

kolumna 7 wiersz 1



tyt / baet

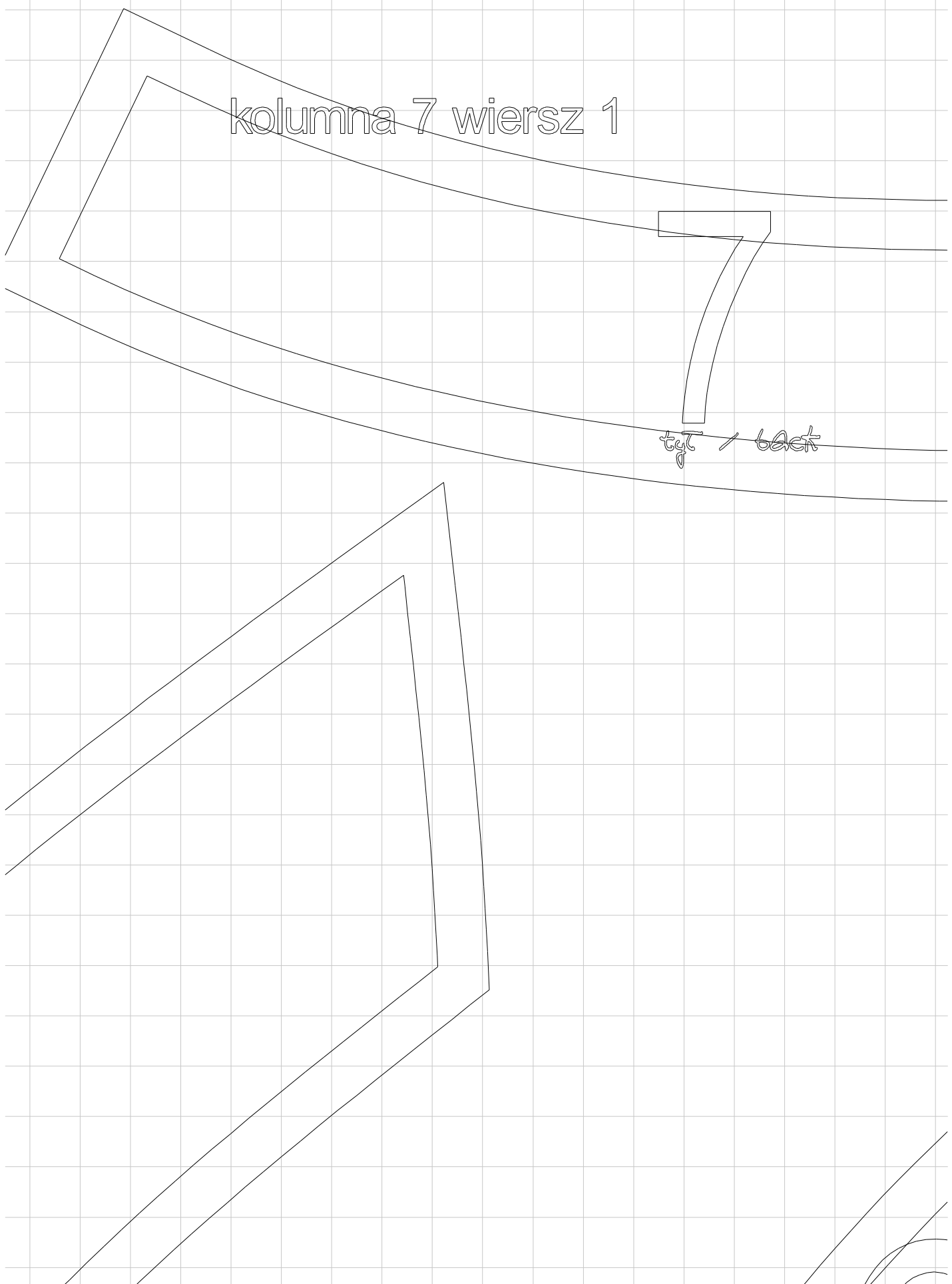

kolumna 7 wiersz 2

ptz

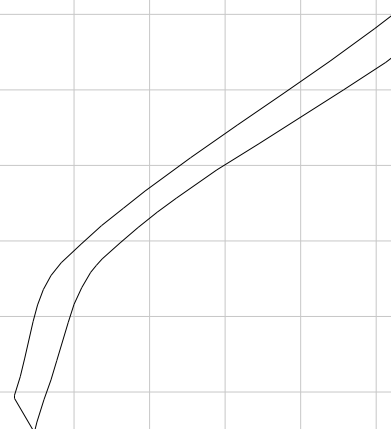
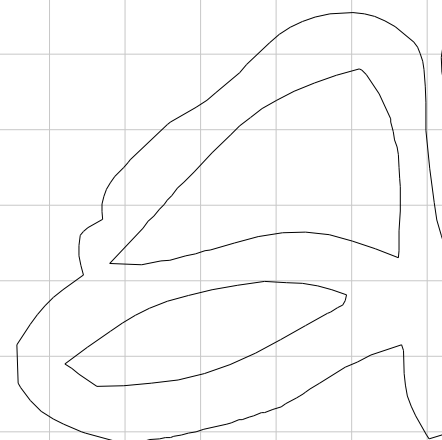

kolumna 7 wiersz 3

straight grain

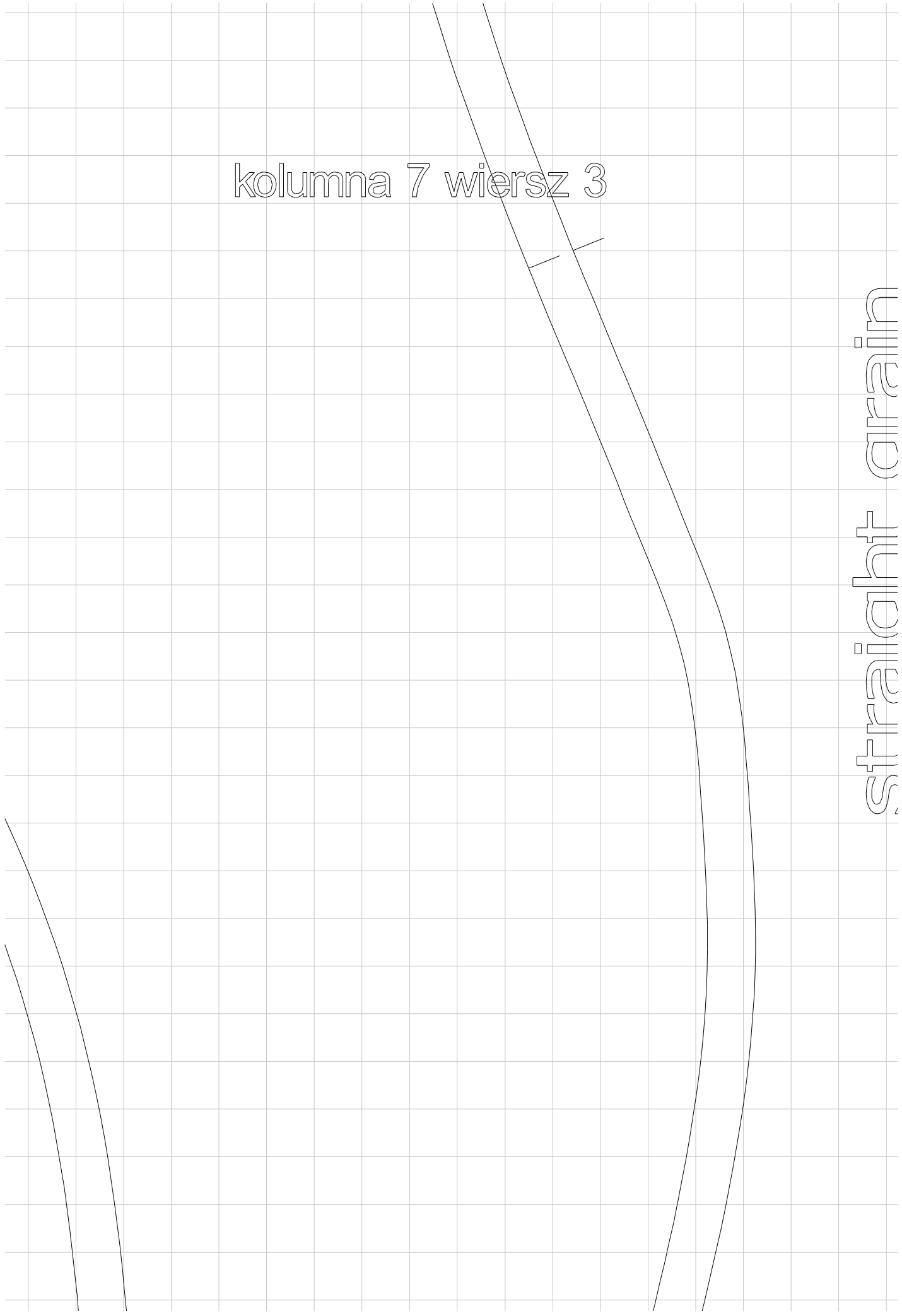

kolumna 7 wiersz 4

ł

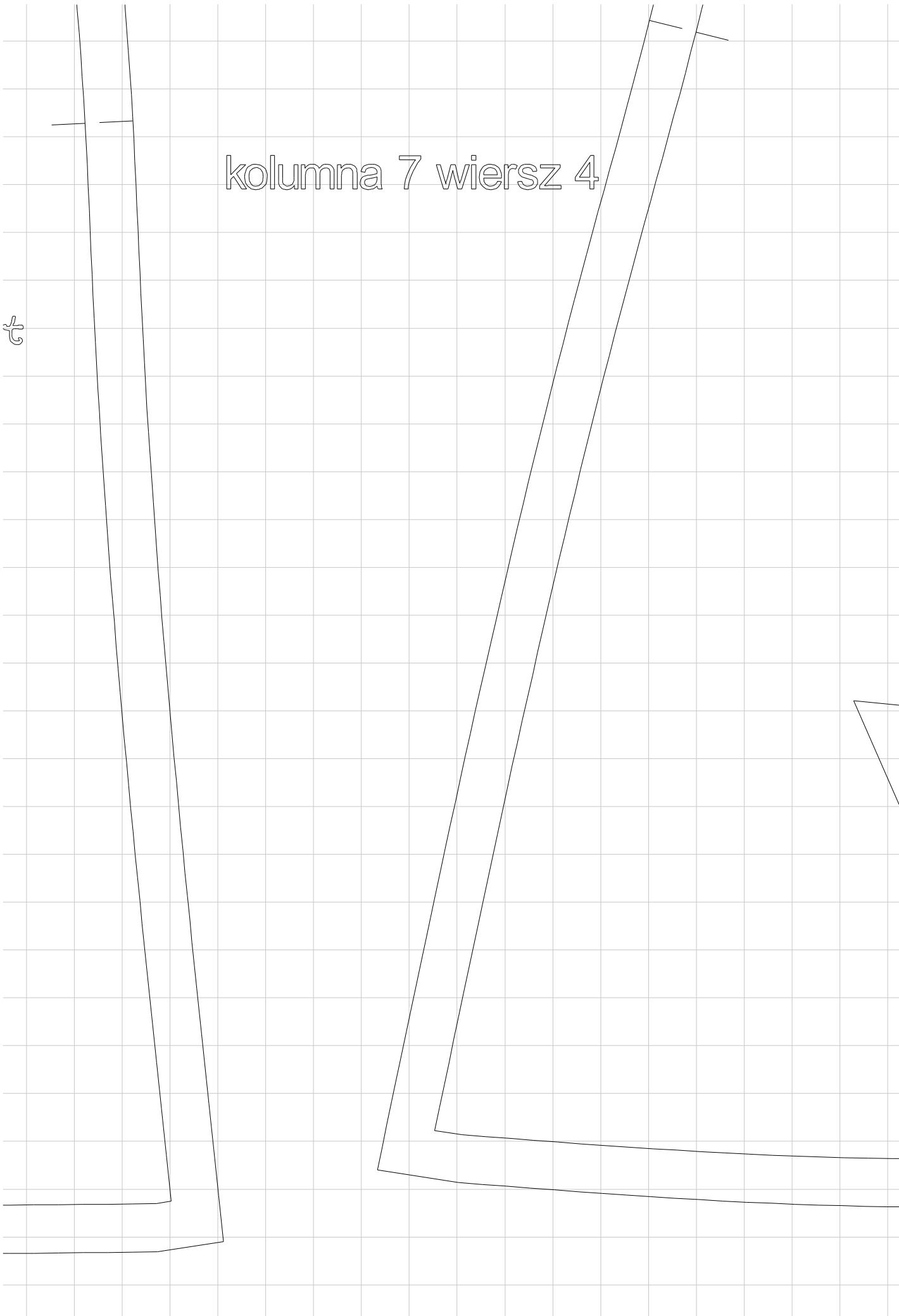

kolumna 8 wiersz 1

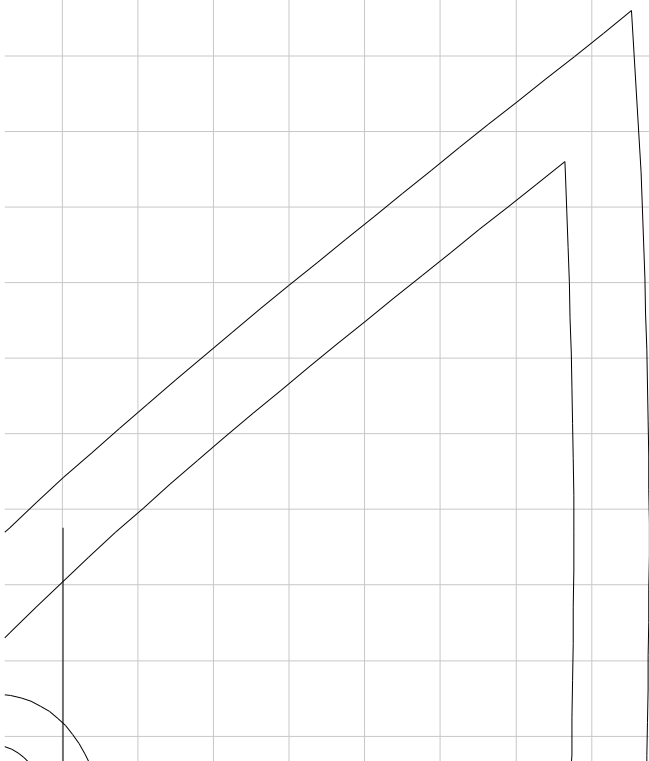

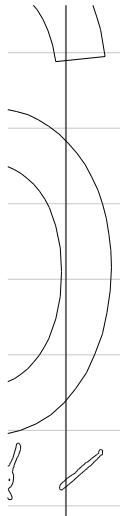

front

kolumna 8 wiersz 2

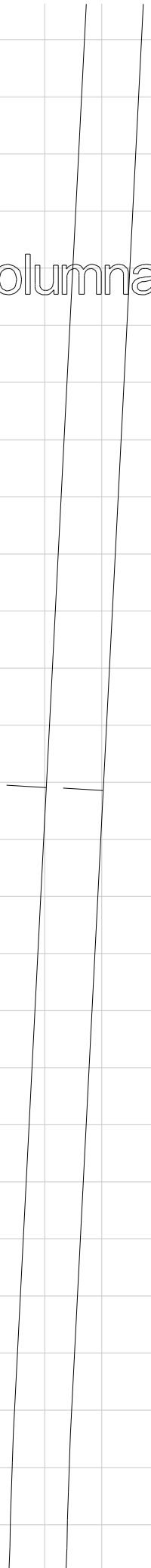

kolumna 8 wiersz 3

nitka prosta

WVWV-V

did.oro.pl

kolumna 8 wiersz 4

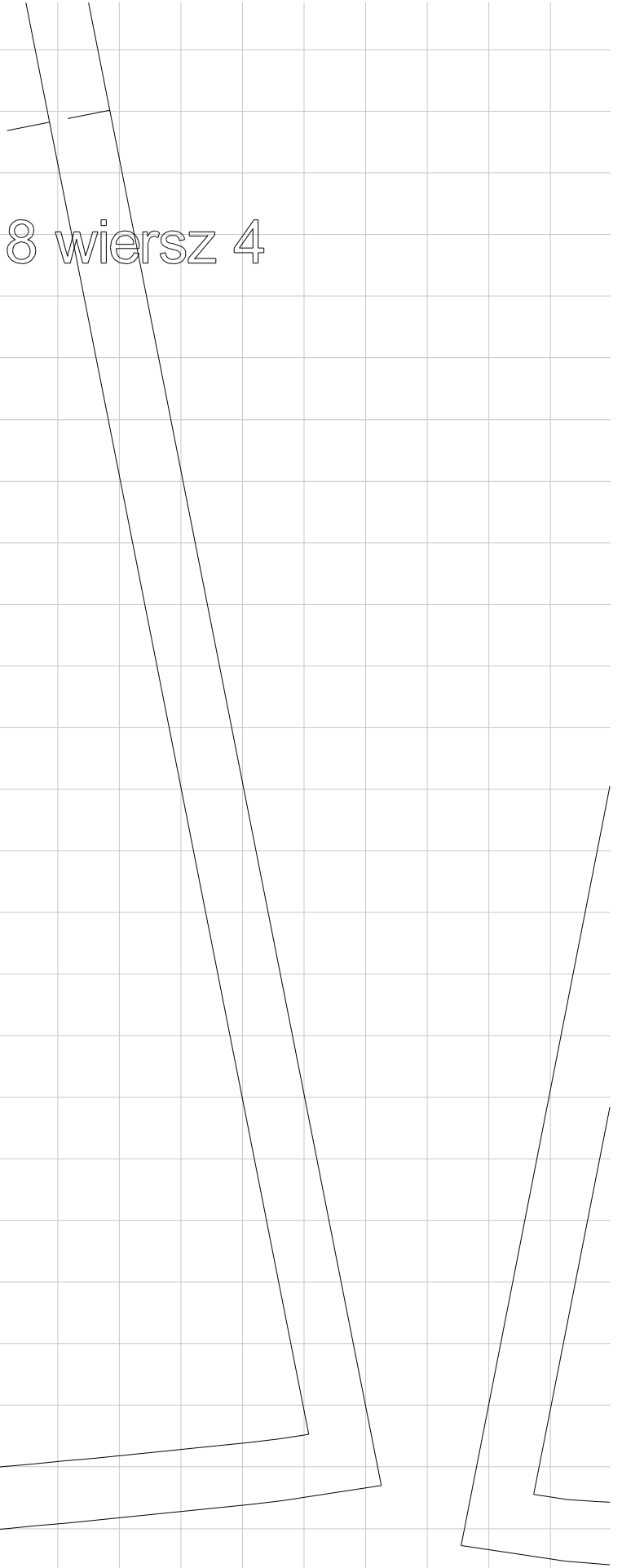
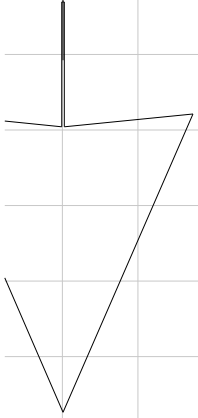

kolumna 9 wiersz 1

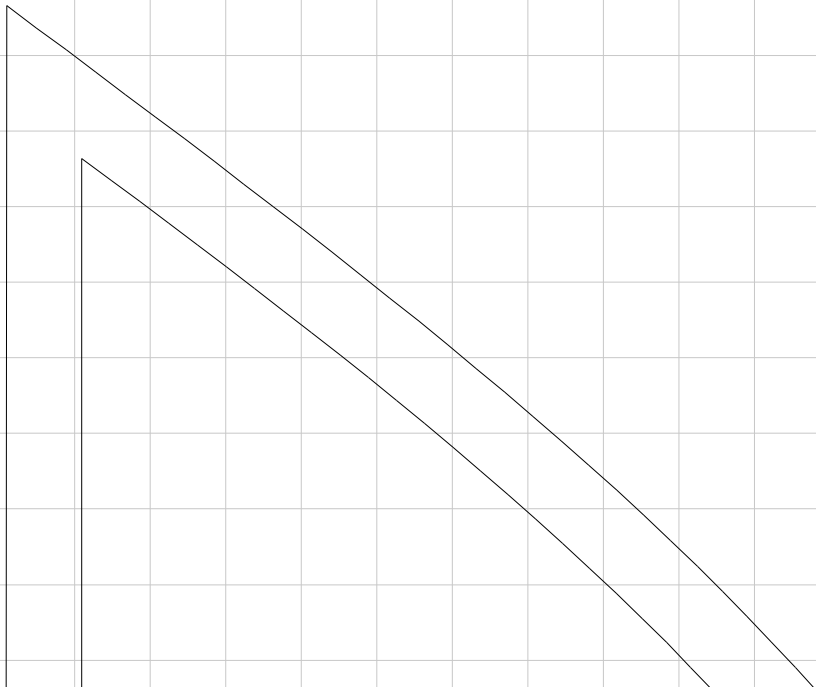

kolumna 9 wiersz 2

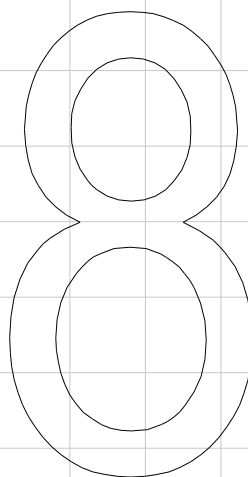

tył / back

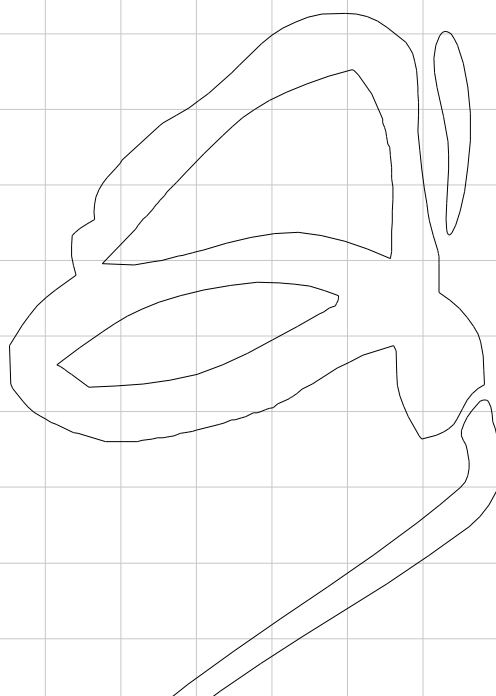

kolumna 9 wiersz 3

straight grain

nitka prosta

WVWVWV

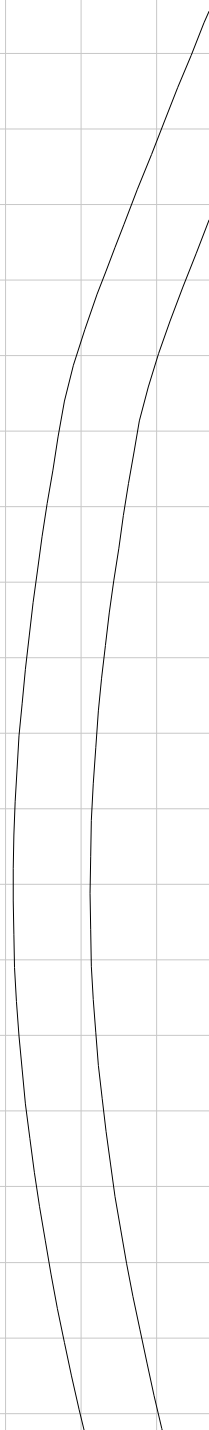

kolumna 9 wiersz 4

di.Overland

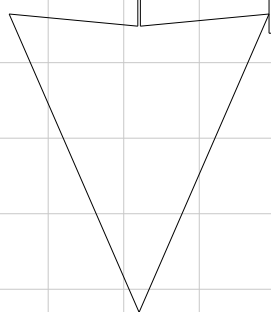

kolumna 10 wiersz 1

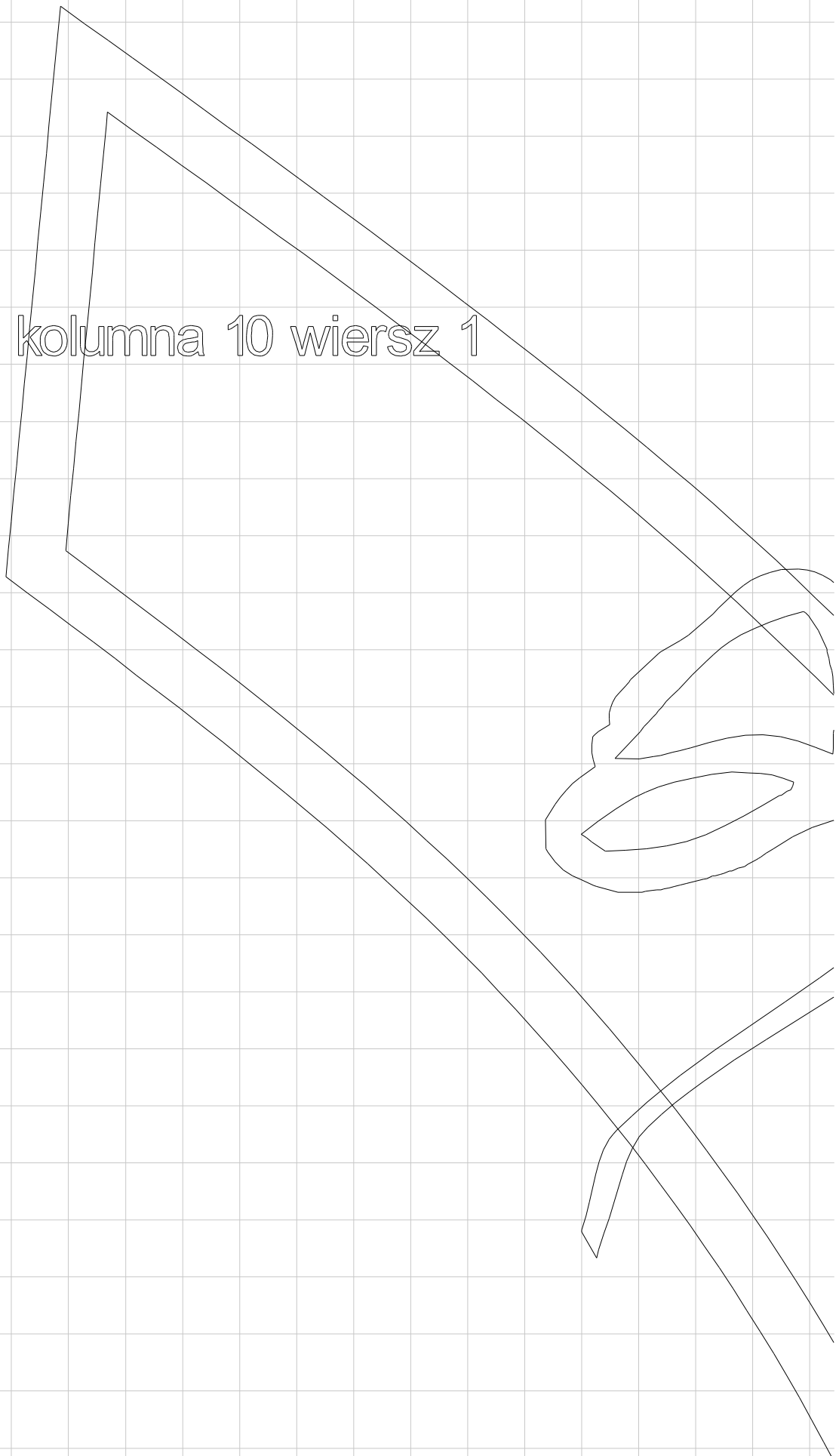

kolumna 10 wiersz 2

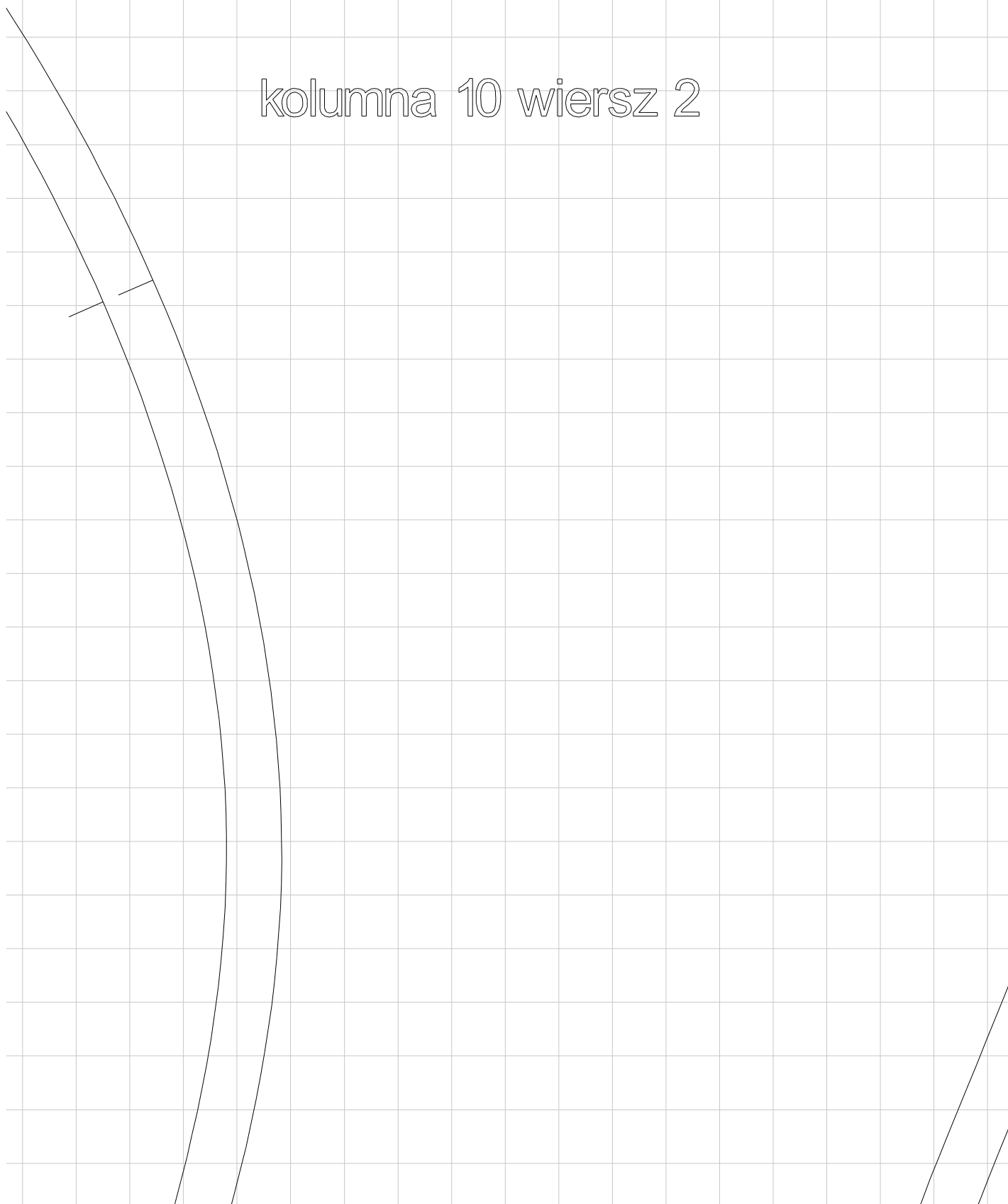

kolumna 10 wiersz 3

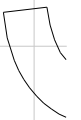

tg

kolumna 10 wiersz 4

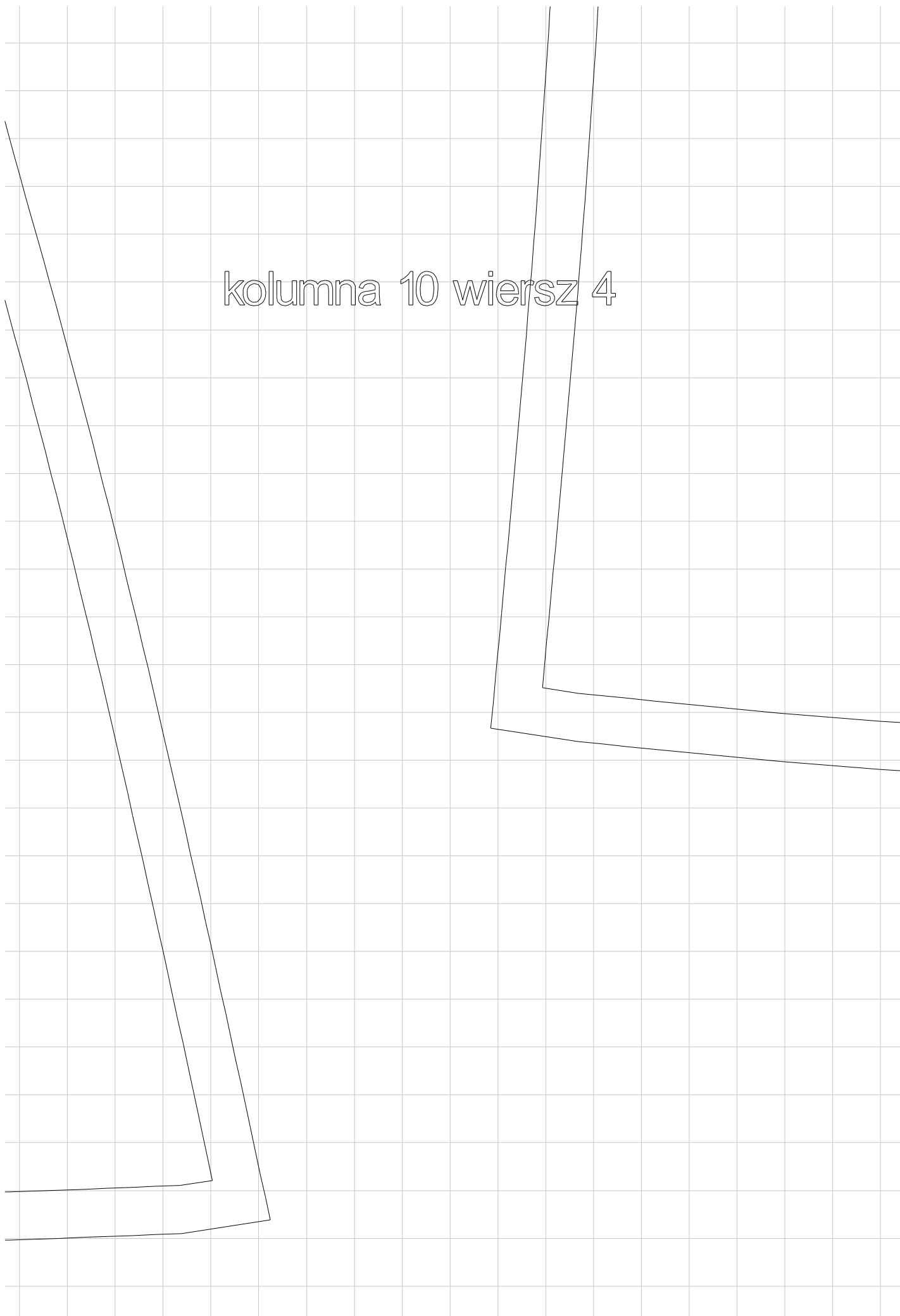

kolumna 11 wiersz 1

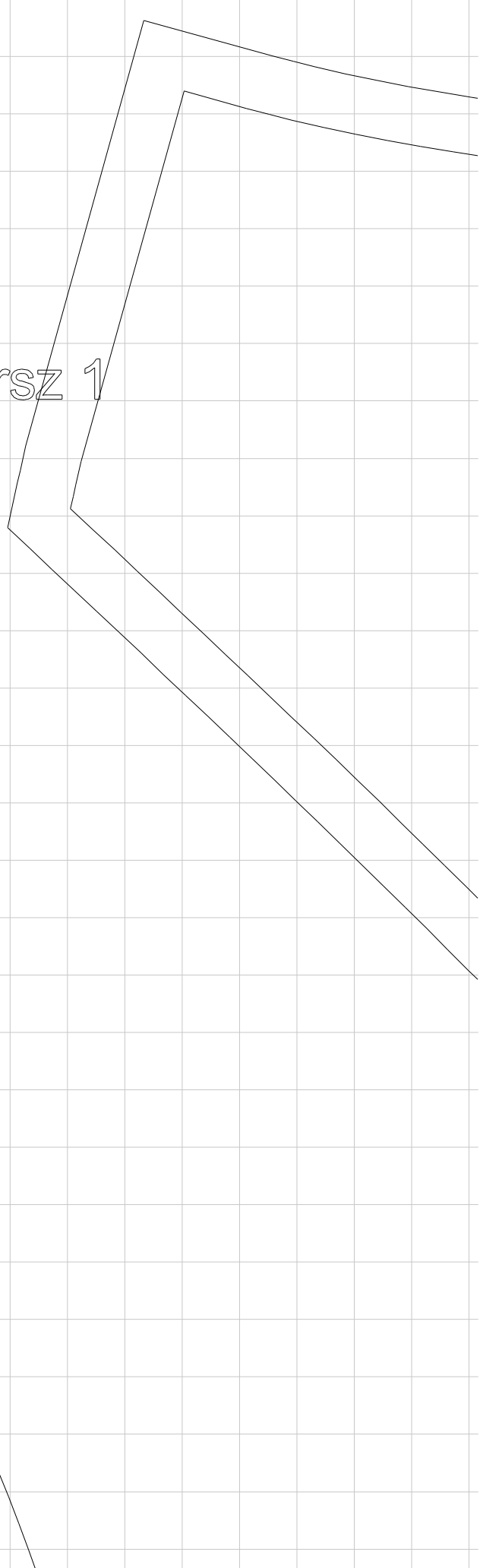
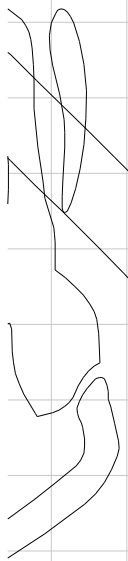



kolumna 11 wiersz 2

V

E

I

kolumna 11 wiersz 4

O

.

i

I

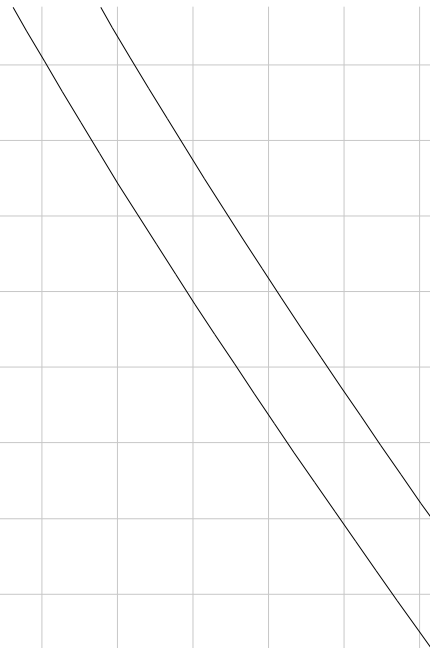

kolumna 12 wiersz 1

10

tyt / back

2

3

kolumna 12 wiersz 2

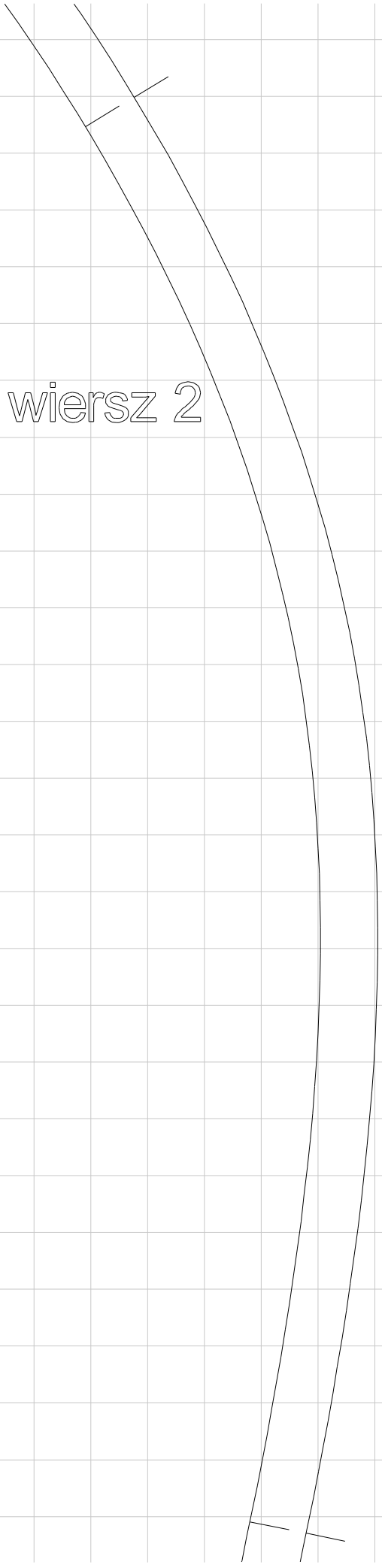

kolumna 12 wiersz 3

© p e d . W W W . p e d .

kolumna 12 wiersz 4

WERTOPI

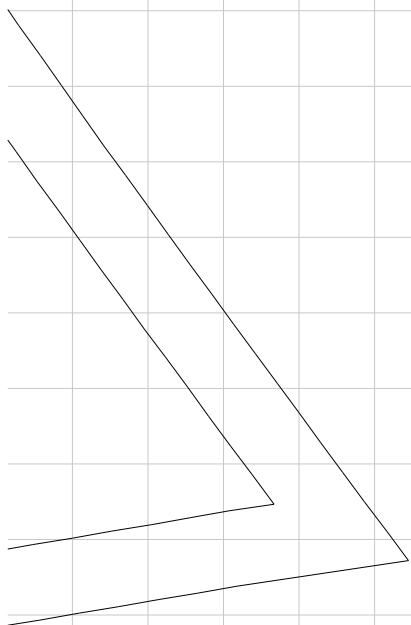

kolumna 13 wiersz 1



joint grain

nitka p

kolumna 13 wiersz 2



strajc

rosta

kolumna 13 wiersz 3



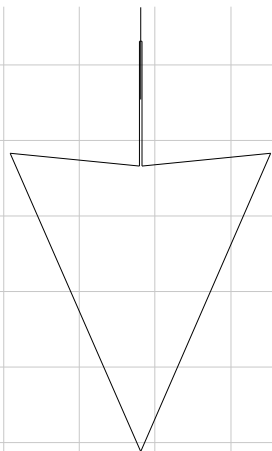

kolumna 13 wiersz 4

]



kolumna 14 wiersz 1

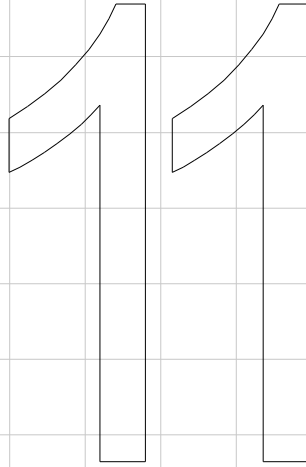

tył / back

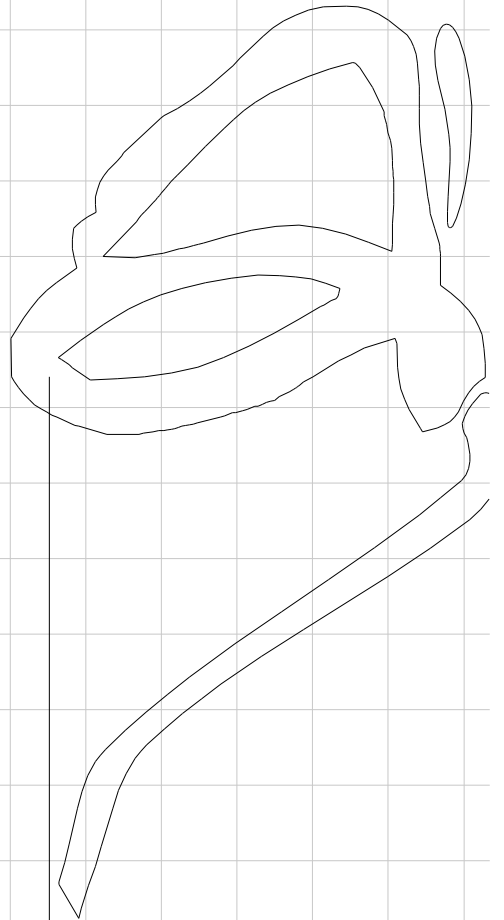

kolumna 14 wiersz 2

kolumna 14 wiersz 3

straight grain

nitka prosta

WVWV.V

kolumna 14 wiersz 4

di.oro.ada

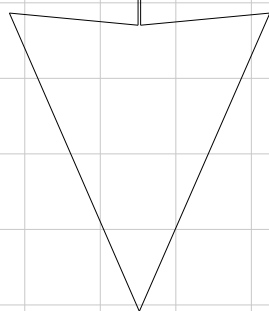

kolumna 15 wiersz 1

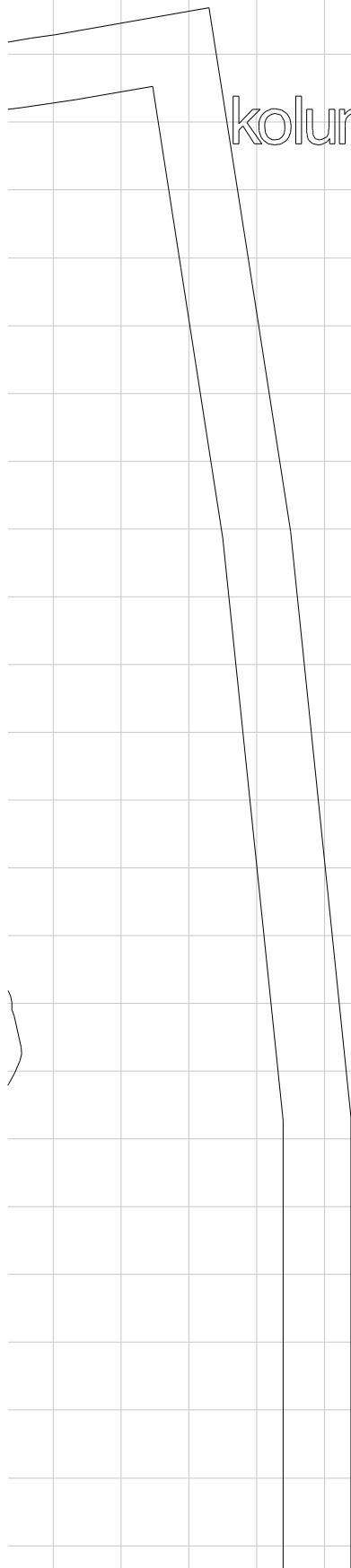

kolumna 15 wiersz 2



kolumna 15 wiersz 3

kolumna 15 wiersz 4

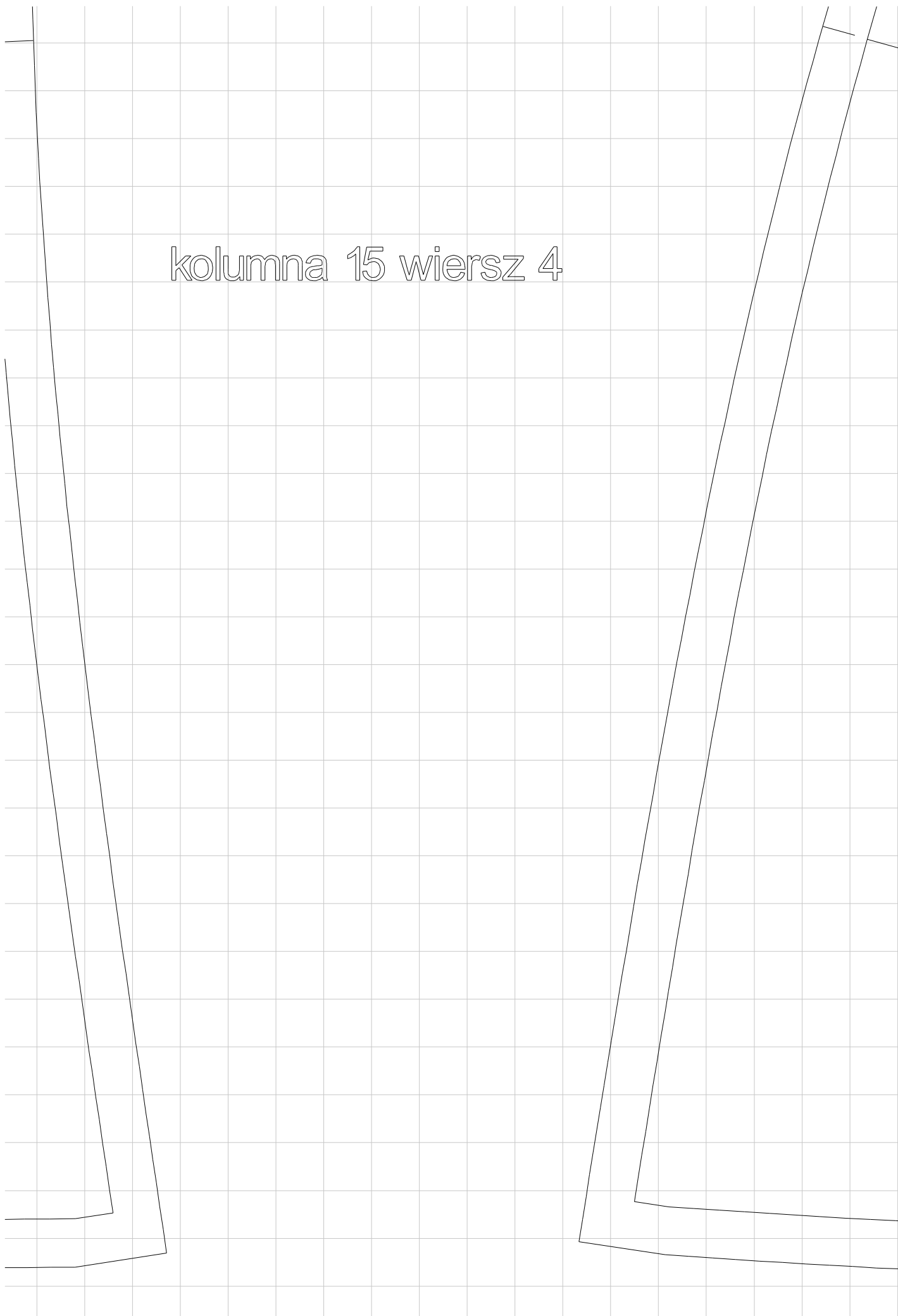

kolumna 16 wiersz 3

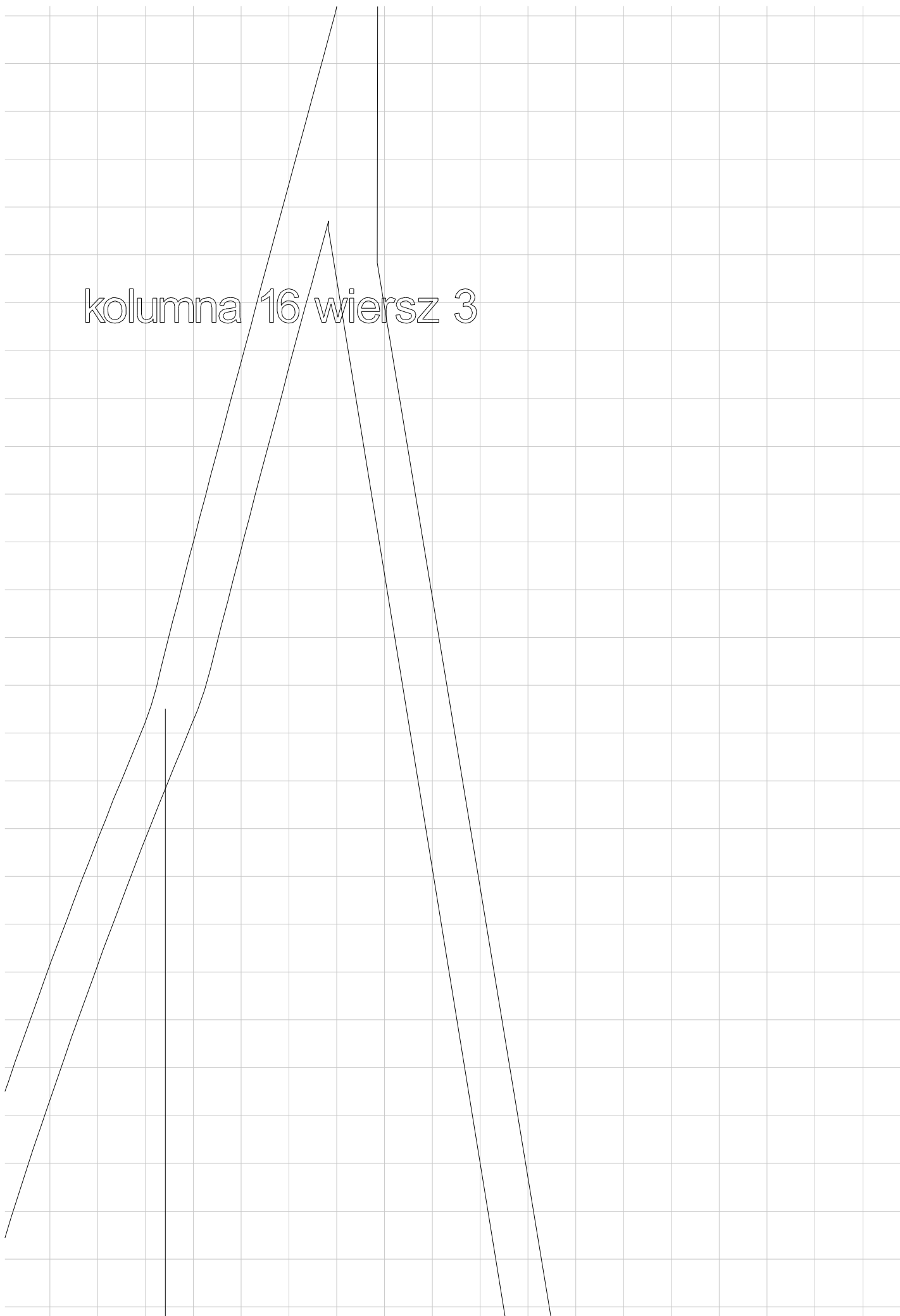

kol
straight grain

nit
prosta

na 16 wiersz 4

